

SPRING CLOSING POWER

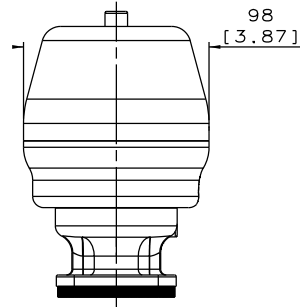

SPRING CLOSING LITE

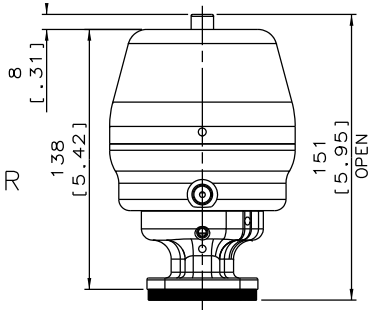
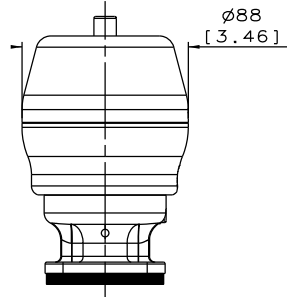
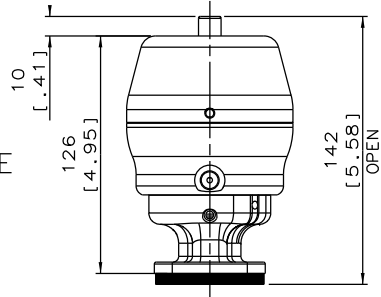

SPRING OPENING

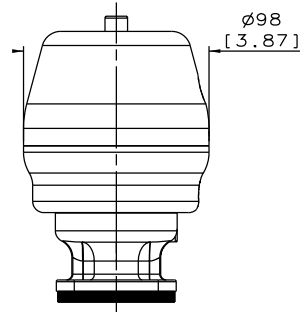
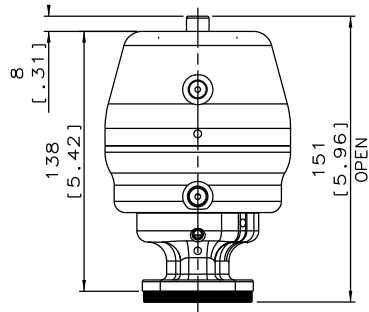

DOUBLE ACTING

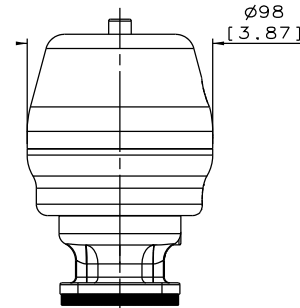
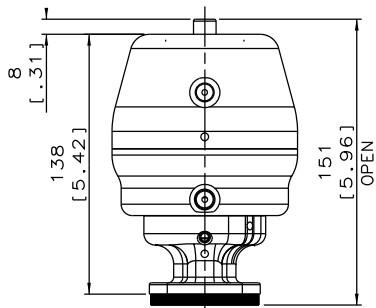

VALVE SIZE	WEIGHT
	KGS
DN20 SC LITE	2.4
DN20 SO	3.1
DN20 DA	2.9
DN20 SC POWER	3.1

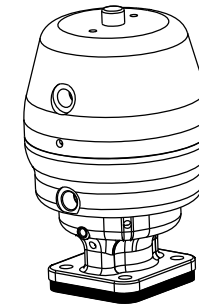
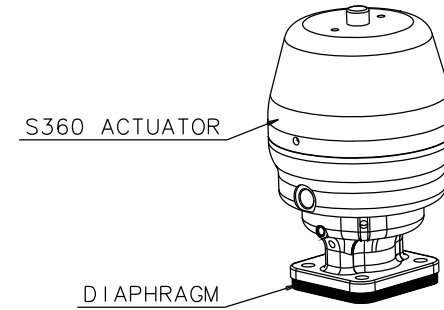

The information on this sheet is Private and Confidential and is the property of Crane Process Flow Technologies Limited and must not be published directly or indirectly in any manner whatsoever without the written permission of the Company and must not be used in any way detrimental to their interests.
© Crane Process Flow Technologies

CRANE Process Flow Technologies
A Crane Co. Company

Saunders
The Science Inside

Title
LEADING DIMENSIONS FOR
DN20 S360 ACTUATORS

Drawn JRD	Date 20.12.11	UNCONTROLLED IN HARD COPY FORMAT
Checked RND	Date 15.11.12	
First Angle Projection Method E	DO NOT SCALE	Drawing No. WEB-117
		Issue. 1