

brands you trust.

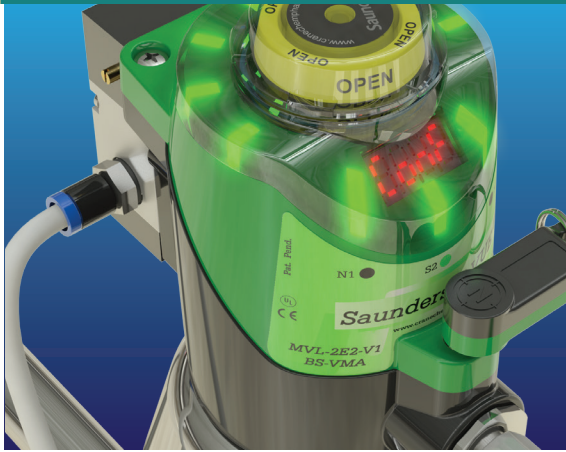

## Saunders<sup>®</sup> Aseptic Diaphragm Valves Overview



Crane ChemPharma & Energy

[www.cranecpe.com](http://www.cranecpe.com)

# Diaphragm Valves History

## PK Saunders® Invented the Diaphragm Valve Concept

PK Saunders® invented and patented the diaphragm valve concept long before the emergence of the Life Science industry. However, the design features present in the original weir type diaphragm valve remain the reasons the aseptic diaphragm valve is recognized as the valve of choice for aseptic applications.

## History of Innovation

Saunders® has led the way in the development of the diaphragm valve to meet ever increasing demands for hygienic performance and regulatory compliance. These innovations have included the introduction of:

- Introduction of forged 316L stainless steel bodies
- First compact pneumatic actuators
- First traceable diaphragms
- First modified PTFE diaphragms
- First controlled sulfur stainless steel bodies
- First compact modular actuators
- First interactive Bio-Block selection guide

## Global Compliance

Aseptic Diaphragm Valves are supplied into critical process applications in the world's most closely regulated industries. Full compliance to all relevant Global Standards is an essential element of the product and cannot be taken for granted. Saunders® complies with all applicable Global Standards for diaphragm valves in the Life Science market, including:

- FDA CFR 177.1550 (PTFE), 177.2600 (Elastomer)
- USP Class VI, <87>, <88>
- Traceable to EN 10204 3.1
- 3A Certification
- Animal Derived Component Free (ADCF)
- ASME BPE
- Testing to BS EN 12266-1
- ISO 9001
- CE and PED 97/23/EC
- TUV-Merkblatt HPO Qualification



## Aseptic Diaphragm Key Products



**Saunders® Standard 2 Ways**

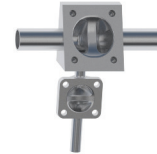

**Saunders® Welded Tandems and Manifolds**



**Saunders® Standard Machined Block and Zero Dead Leg**

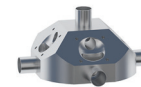

**Saunders® HC4 Bio-Blocks**



**Saunders® Actuation S360 & P345**



**Saunders® Controls**



**Saunders® HC4 Diaphragms**

## Focused Industries



**BioPharm**



**API  
(Active Pharmaceutical Ingredients)**

CRANE ChemPharma, Saunders® is a global supplier to biotech, Pharmaceutical, and other related markets, including: Food and Beverage • Consumer Products • Paint • Silicon • Biofuel • Fermentation • Cosmetics.

# Diaphragm Valves Interactive Web-Based Tools

Saunders<sup>®</sup> has developed interactive web-based tools to facilitate selection of standard and customized valves. This includes our Biotech Process Map which saves time and effort in valve selection in an industry driven by time to market. Our P&ID Table of Orientations provides key design information such as drawings and datasheets for over 100 different valve orientations based on P&ID configuration. Also available is our drawing library which makes 2D pdfs available to all site visitors and 2D dwg and 3D stp files readily available to registered users.

## SELECT

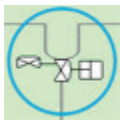

**BIO-BLOCK  
PROCESS APPLICATIONS**



**BIO-BLOCK PIPING AND  
INFORMATION  
DRAWINGS (P&ID)**



**HC4 DRAWING LIBRARY**



**Saunders<sup>®</sup> Maintenance Center**

## DISCOVER

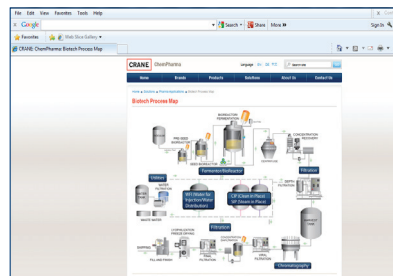

**Biotech Process Maps**

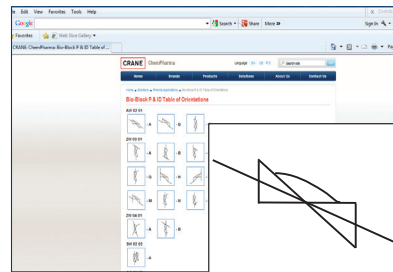

**Various P&ID  
Orientations**

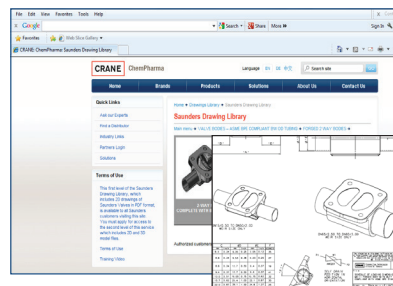

**Download Engineering  
Drawings (2D and 3D)**

**SAUNDERS<sup>®</sup>  
MAINTENANCE CENTER**

## SOLVE



**Solutions for Your Applications**

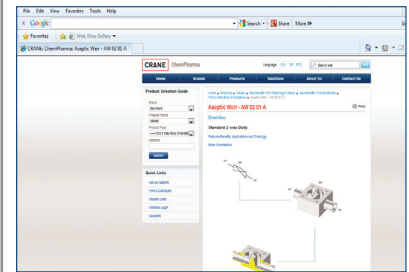

**Solutions For Your  
Bio-Block Process**

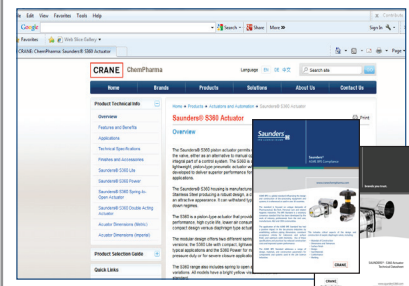

**Download Technical  
Datasheets**

**Up-to-date 3D product training  
videos and presentations  
for the installation and  
maintenance of Saunders<sup>®</sup> HC4  
valves, switches, and sensors.**

Please visit [www.saundersdrawings.com](http://www.saundersdrawings.com) for current library of drawings in PDF, 2D DWG, and 3D STP formats.

# Diaphragm Valves Body Design and Finish

## Saunders<sup>®</sup> Body Range

Saunders<sup>®</sup> offers bodies with weld and clamp ends to meet all global tube and pipe specifications. This includes: OD tube, DIN, ISO, SMS and schedule pipe.

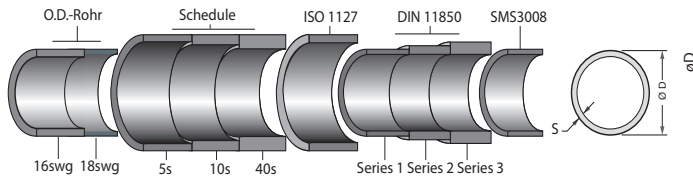

Standard body material for all forged bodies is stainless steel dual certified to 316L (ASTM A-182) and DIN 1.4435 with the additional requirement of controlled sulfur per ASME BPE Standard.

Cast bodies are available from 316L stainless steel. Bodies produced from alternate materials such as Hastelloy<sup>®</sup>, AL6XN, 904L and Titanium are also available.

For further information about Saunders<sup>®</sup> body ranges, download applicable datasheets at: [www.cranebiopharm.com](http://www.cranebiopharm.com).

## Surface Finish

Saunders<sup>®</sup> valve bodies are available in all mechanically polished and electropolished surface finish options to match piping system specification. Saunders<sup>®</sup> valve bodies are also available in a complete range of ASME BPE compliant internal surface finishes.

## Saunders<sup>®</sup> Full Range of Surface Finish Options

Finish	Product Contact (ID) Surface Finish Options						
	Measurement				Body Type		
	Ra* (micro inch)	Ra* (micro meter)	ASME BPE SF Code	Saunders <sup>®</sup> Type	Forged	Machined	Cast
Mechanical Only	30	0.8	SF3	N/A	Yes	Yes	Yes
Mechanical Only	25	0.6	SF2	N/A	Yes	Yes	Yes
Mechanical + EP	25	0.6	SF6	N/A	Yes	Yes	No
Mechanical Only	20	0.5	SF1	Satin	Yes	Yes	Yes
Mechanical + EP	20	0.5	SF5	Satin	Yes	Yes	No
Mechanical Only	15	0.4	N/A	N/A	Yes	Yes	Yes
Mechanical + EP	15	0.4	SF4	N/A	Yes	Yes	No
Mechanical Only	10	0.25	N/A	Mirror	Yes	Yes	No
Mechanical + EP	10	0.25	N/A	Mirror	Yes	Yes	No

\*All Ra values are maximum.

Hastelloy<sup>®</sup> is a registered trademark of Haynes International, Inc.

## Drainability

The diaphragm valve has outstanding self-draining characteristics and is capable of draining in both vertical and horizontal orientations.

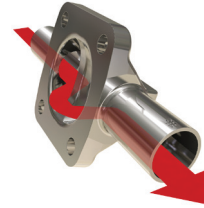

Factors which affect drainability include:

- Valve size and tube specification
- Internal surface finish
- Drain orientation
- Surface tension and viscosity of media
- Pipe run angle – generally recommended at 2–3 degrees

Drainability in a process system is ultimately the responsibility of the system designer and end user as a result of the factors explained above.

## Electropolishing

Electropolishing of mechanically polished product contact surfaces improves surface finish smoothness and corrosion resistance. Mechanical polishing or machining may leave numerous microscopic surface imperfections which can cause areas of differing electrical potential due to surface stresses.

Please visit [www.saundersdrawings.com](http://www.saundersdrawings.com) for current library of drawings in PDF, 2D DWG, and 3D STP formats.

# Diaphragm Valves Standard 2-Way Bodies

## Standard 2-Way Bodies

The standard 2-way valve body is the basic building block of diaphragm valve technology. CRANE ChemPharma, Saunders<sup>®</sup> 2-way forged bodies are manufactured from wrought 316L/1.4435 stainless steel bar with additional requirement of controlled sulfur per ASME BPE Standard.

The forging process results in a homogeneous surface that helps to eliminate porosity, inclusions, or shrinkage cavities. This surface is an ideal substrate for the high levels of mechanical and electropolished surfaces demanded by the clean processing industries to maintain sterility and optimize cleaning processes. CRANE ChemPharma, Saunders<sup>®</sup> forged bodies are manufactured to achieve low ferrite levels of less than 0.5% maximum. This reduces the potential for migration of oxides through a high purity water system.

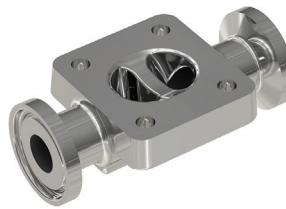

**Tri-Clamp Ends**



**Butt Weld End**



**Traceability**

### Valve Body Features

- ① Cavity-free and self-draining
- ② Full traceability to EN 10204 3.1 and ASME BPE
- ③ Serialized bodies for traceability and ASME BPE bodies are marked in accordance with DT 11-1

### Forged Body Features:

- ① Hash marks to indicate self drain angle
- ② Integral weld and hygienic clamp ends
- ③ Controlled sulfur, 0.005-0.017% per ASME BPE Standard
- ④ Certified to ASTM A-182 and DIN 1.4435
- ⑤ Full compliance with weld end tangent length as per DT-4.1.1 and with clamp end lay length per DT-4.4.1-1

2-Way Bodies		
Body Type	Size Range	Applications
Forged Stainless Steel 2-Way	DN15 - DN80 (1/2" - 3")	Forged products are used where conformity is essential such as high purity Biopharm applications.
Pure Performance (Bio-Seal) Forged Body	DN8 - DN15 (1/4" - 1/2")	Compact, space saving, high integrity, for critical applications. Process valve, sample, or drain port in hygienic system design.
Machined from Block 2-Way Valve Body	DN100 - DN150 (4" - 6")	Larger size designations are machined from solid wrought stainless steel barstock. This construction brings the same level of surface integrity and metallurgical security as available with 2 Way Forged bodies.
Investment Cast Stainless Steel 2-Way Bodies	DN8 - DN100 (1/4" - 4")	Ideal for clean industries where the requirements of the process are less critical.

Please visit [www.saundersdrawings.com](http://www.saundersdrawings.com) for current library of drawings in PDF, 2D DWG, and 3D STP formats.

# Diaphragm Valves Custom Valve Solutions



**Machined Tandem**



**Fabricated Tandem**



**Valve Manifold/Clusters**

## Custom Valve Solutions

Custom valve types may be welded tandem valve assemblies, machined from solid block types or manifolds that incorporate both technologies.

### Custom Valve Solutions Benefits:

- 1 Reduced wetted area to reduced dead legs
- 2 Improved drainability and reduced design envelope over arrangements using individual 2-way valve bodies
- 3 Machined from solid bodies also offer increased security due to the elimination of internal fabrication welds.

## Tandem Valves (Sterile Access Valves)

Tandem valves are designed to optimize drainability and meet process design requirements for minimum dead legs. A main valve is ported and a second access valve is welded to the main valve to create a tandem cluster.

### Machined Tandem Valves

The Machined Tandem is a variation of the Serial Weir family.

This machined from solid Tandem Valve type offers several advantages over the welded tandem:

#### Machined Tandem Valve Benefits:

- 1 Increased security – no internal fabrication welds
- 2 Reduced dead leg – depending on orientation
- 3 Greater structural integrity

### Valve Manifold / Clusters

Configuration of optimum process fabrication presents system designers with an ongoing challenge. Minimum space envelope, reduced hold up areas, reduced cost, and facilitating ease of installation are all key considerations.

#### Optimum Process Fabrication Benefits:

- 1 Tailor-made solutions to customer requirements
- 2 Fully-tested assembled units manufactured under controlled conditions
- 3 Full traceability of all components
- 4 Reduced on-site fabrication time and costs

Please visit [www.saundersdrawings.com](http://www.saundersdrawings.com) for current library of drawings in PDF, 2D DWG, and 3D STP formats.

# Diaphragm Valve Zero Dead Leg and Point-of-Use

## Zero Dead Leg 'Tee' Pattern Range

The Zerostatic Tee valve combines a single weir with a tee pattern body. This design eliminates the dead leg present when a 2-way valve is welded or clamped to a tee fitting and has become a BioPharm standard. Essential for the elimination of dead legs in recirculating loops and designed to ease installation and validation, Saunders<sup>®</sup> Zerostatic Tee Valve enhances the integrity of critical systems.

### Zerostatic Tee Valve Benefits:

- 1 Compact design providing excellent drainage characteristics and absence of dead leg
- 2 Machined block construction with no internal fabrication welds offer optimum security
- 3 Sampling/injection points on high purity water systems



**Zero Dead Leg 'Tee' Pattern Range**



**Point-of-Use Options**



**Zero Dead Leg 'Tee' Pattern Range**

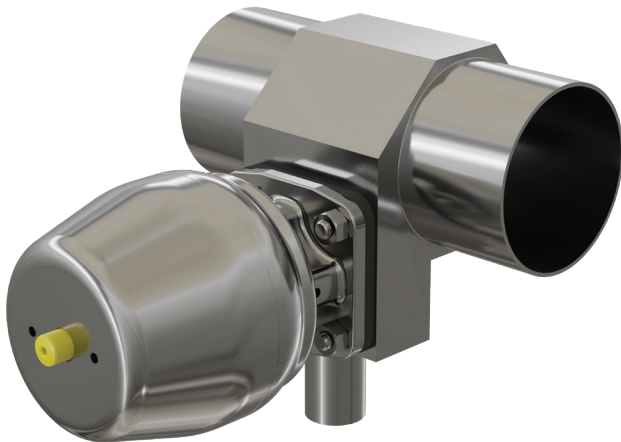

## Point-of-Use Options (Zerostatic Valve with 'U' Bend)

One of the most sensitive applications in a WFI loop is the use point valve. These valves represent the barrier between the safety of the re-circulating loop and the potential hazards of the environment and function as the take off point for consumption of WFI. Valves for this application need the highest level of design security, integrity, and cleanliness. Saunders<sup>®</sup> point-of-use valves are engineered to minimize dead areas and fully drain all associated tubing.

Please visit [www.saundersdrawings.com](http://www.saundersdrawings.com) for current library of drawings in PDF, 2D DWG, and 3D STP formats.

# Diaphragm Valves Bio-Block and Compound Solutions

## Bio-Block Compound Solutions

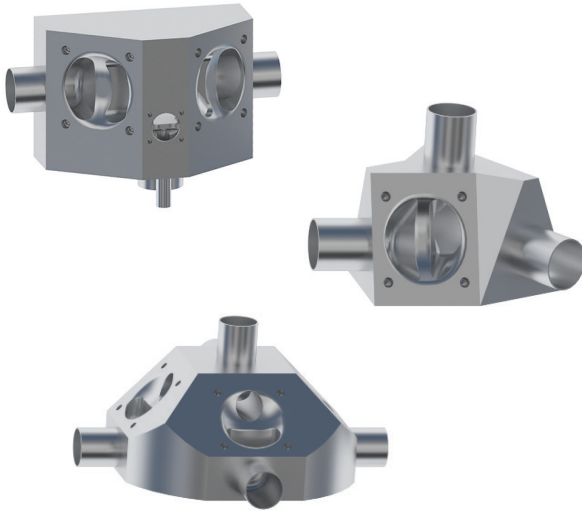

## Bio-Block Valves

Bio-Block valves offer the foremost expression of aseptic diaphragm valve technology. Bio-Block designs are machined from solid bar or billet to create tee configurations or clusters of two or more weirs with shared chambers that result in a single design with reduced wetted area, optimum drainability and the highest level of integrity.

## Bio-Block Compound Solutions

Almost every process system includes a unique piping challenge that does not lend itself to conventional solutions. Saunders<sup>®</sup> custom designed Bio-Block valves replace welded clusters, manifolds, and valve/fitting combinations and offer the most compact, minimum dead leg design for optimum process integrity.

Saunders<sup>®</sup> Sales and Engineering is pleased to work with you to identify and select the ideal valve design to optimize the performance of your system. Please contact your local distributor or CRANE ChemPharma sales office for support.

## Bio-Block Categories Machined From Solid Options

1. Zerostatic Weir: Tee fitting and weir combined
2. Serial Weir: Two weirs sharing a common chamber
3. Multiple Weir: Three or more weirs with a common chamber
4. Tank Weir: Weir integrated into tank bottom
5. Compound Bio-Block: Combination of Bio-Block types into one assembly

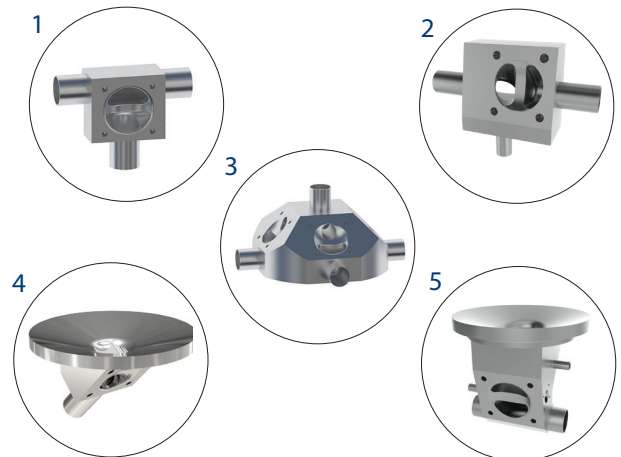

Please visit [www.saundersdrawings.com](http://www.saundersdrawings.com) for current library of drawings in PDF, 2D DWG, and 3D STP formats.



# Diaphragm Valves Multi-Port and Tank Bottom

## Multi-Port Diverter Valves - Zero Dead Leg Options

The family of Multi-Port valves includes the Diverter Valve range. These valves include 2-way diverters on through to clusters that have up to eight outlets.

Modern machining technology is employed in the design and manufacture of Saunders<sup>®</sup> range of Bio-Block diverter valves. The result is a single valve without internal fabrication welds for maximum strength, with reduced holdup volumes and without stagnant areas.

On one side of the weir there is a common chamber and on the other side of the weir the flow is divided and split into multiple control points. Diverter valve designs are ideal solutions whenever a process line needs to be divided into two or more process streams or when multiple lines are combined into one.

## Multi-Port Diverter Valves

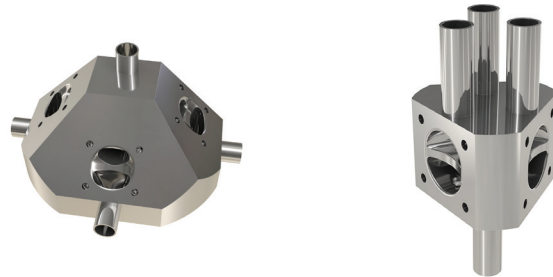

## Tank Bottom Valves



### Multi-Port Deverter Valve Benefits:

- 1 Machined block construction, free from fabrication welds to enhance structural integrity
- 2 Minimal dead leg design will reduce risk of process contamination
- 3 Excellent drainage characteristics for quick and effective sterilization
- 4 Reduced space requirement provides greater flexibility in system design and simplified installation
- 5 Fully-certified range, with comprehensive validation support documentation on request

## Tank Bottom Valves

The Saunders<sup>®</sup> tankbottom valve incorporates the performance and features of a diaphragm valve into a machined from solid tank outlet design. These valves are free from fabrication welds and dead legs, enhancing structural integrity and reducing the potential for process contamination. The absence of dead legs also improves drainability, and facilitates effective mixing.

Sample valves, purge valves and ports are easily incorporated into the tank bottom design to achieve the desired performance.

The resulting valve types are a hybrid or compound solution that entails the use of more than one valve concept; for example, combining a tank bottom valve with an access valve, a multi-port valve with access valves to perform as steam and condensate port or a point-of-use valve together with a sample valve. This process, combined with our manufacturing expertise, results in custom valve configurations that combine utility and performance.

Please visit [www.saundersdrawings.com](http://www.saundersdrawings.com) for current library of drawings in PDF, 2D DWG, and 3D STP formats.

## Diaphragm Valves Pneumatic Actuator S360



**Saunders® S-360  
Compact Actuation**



**DN100 Compact Tank  
Bottom Valve**



**M-VUE and I-VUE  
Sensors Direct Mount  
on S360 Actuator**

### Key Features and Benefits

- 1 Modular range delivers compact dimensional envelope to reduce dead-leg between associated valves and optimises system design
- 2 Maintenance free piston technology provides powerful closure performance
- 3 Smooth corrosion resistant profile optimizes cleanability

### Saunders® S360 Lite

The Saunders® S360 Lite range provides standard closure for normally closed applications in a compact, lightweight package and is available through sizes DN8 – DN100 (0.25" – 4.00").

The S360 Lite range is a very compact actuator that offers shutoff performance in line with standard industry applications. The S360 Lite is available in normally closed mode of operation with optimised spring force up to closure to minimize stress on diaphragms. Suitable for 10 bar line pressure (Rubber diaphragm) and 8 bar (PTFE diaphragm) at 100% Delta P.

### Saunders® S360 Power

The Saunders® S360 Power range offers higher operating closure performance in a compact package for high operating pressure or atypical closing conditions with high pressure on both sides of the weir. The S360 Power normally closed actuator is available through sizes DN15 – DN50 (0.50" – 2.00").

The Saunders® S360 actuator is also available in normally open and double acting modes. Suitable for 16 bar line pressure at 100% Delta P (both PTFE and Elastomer diaphragm).

### Easy Compressor Change

The Saunders® S360 has a unique compressor attachment that permits easy conversion of the compressor between rubber and PTFE diaphragms, minimizing the need to hold two sets of actuators in stock.

### Saunders® S360

The S360 is a compact, lightweight, piston-type pneumatic actuator which has been developed to deliver superior performance for sterile BioPharm applications.

Please visit [www.saundersdrawings.com](http://www.saundersdrawings.com) for current library of drawings in PDF, 2D DWG, and 3D STP formats.

# Diaphragm Valves P345 Actuator

## Pneumatic Actuator P345

Saunders P345 is a compact polymer pneumatic actuator designed to provide superior performance in Bioprocess applications and delivers operational savings in terms of plant efficiency and air consumption.

### Key Features

1. 4.5 BAR OPERATING PRESSURE: LOWER TOTAL COST OF OWNERSHIP THROUGH REDUCED AIR CONSUMPTION
2. INDUSTRY LEADING CLOSURE PERFORMANCE: 10 BAR @100% ΔP FOR RUBBER & PTFE DIAPHRAGMS
3. LIGHT WEIGHT CONSTRUCTION: 30% LIGHTER COMPARED TO STAINLESS STEEL VARIANT
4. ZERO MAINTENANCE: MAINTENANCE FREE PLUG-N-PLAY RELIABLE OPERATION



### Size Range

- DN8 (0.25") – DN100 (4.00")

### Modes of Operation

- Spring-to-Close
- Double Acting

### Material of Construction

- Polymer Cover: Polyamide
- Bonnet: Stainless Steel

### Temperature

- Max: 100°C
- Min: -10°C

### Accessory Options

- Saunders-VUE Sensors (direct mount)
- Limit Open Stop (Spring-to-Close mode)
- Positioners

### Diaphragm Interchangeability

- Unique compressor design that permits easy conversion of the compressor between rubber and PTFE Diaphragms

Please visit [www.saundersdrawings.com](http://www.saundersdrawings.com) for current library of drawings in PDF, 2D DWG, and 3D STP formats.

## Diaphragm Valves Sensors, Switches and Controls

**Saunders-VUE portfolio offers industry leading automation technology that adds intelligence to a diaphragm valve, delivering savings to the customer.**

### TOTAL COST OF OWNERSHIP

DELIVERS \$1.3M SAVINGS  
IN 5 YEARS FOR 2800 SENSOR FACILITY

### ZERO MAINTENANCE

CONTACTLESS OPERATION WITHOUT ANY  
ROUTINE MAINTENANCE

### RELIABLE & ACCURATE

STATE OF THE ART CONTINUOUS SENSING  
MAGNETIC TECHNOLOGY

### INTELLIGENT

OFFERS REMOTE DIAGNOSTICS TO  
OPTIMIZE PREVENTIVE MAINTENANCE



As the inventor of the diaphragm valve, Saunders<sup>®</sup> has been a key player in the evolution of high purity valve technology. Continuing the lead in aseptic valve technology, Saunders<sup>®</sup> has engineered a suite of automation products that add intelligence to a diaphragm valve offering new possibilities to our customers.

Saunders-VUE offers intelligent solutions for diaphragm valves in the Life Science Industry. Saunders-VUE platform is designed to maximize plant efficiency by eliminating false alarms and reducing set-up times. Saunders-VUE valve sensors provide a wide variety of diagnostic features that help in continuous monitoring and preventative maintenance. All the unique features can be operated remotely over an industrial network or locally using a magnetic key to extract diagnostics and facilitate safe, secure and efficient processing and maintenance.

Saunders-VUE range of valve sensors are designed to provide positive and accurate confirmation of valve position while delivering a wide variety of diagnostics to enable continuous monitoring and preventative maintenance.

- Saunders-VUE Sensors are contactless and operated either by a magnetic key or remotely through an industrial network.
- Focused on delivering valve intelligence, Saunders-VUE sensors offer millions of dollars of savings to the customer throughout the lifetime of the sensor.
- Saunders-VUE sensors are available in point-to-point (P2P), AS-i and DeviceNet versions.
- \$1.3 million in savings over approximately five years for a 2800 sensor facility.

**Saunders-VUE automation solution adds intelligence to a diaphragm valve!**

Please visit [www.saundersdrawings.com](http://www.saundersdrawings.com) for current library of drawings in PDF, 2D DWG, and 3D STP formats.

# Diaphragm Valves Manual Bonnets Overview

## Key Features and Benefits

- 1 Clean external profile to facilitate wash down and cleaning regimes
- 2 Suitable materials, corrosion resistant polymer and stainless construction
- 3 FDA conforming lubricants
- 4 Compact design easily integrated into process system
- 5 Autoclavable types for valves subject to repeated autoclaving
- 6 Modular options including limit open and limit closed stops, padlocking device and switches



**PES Performance Bonnet**



**Para Bonnet**



**Sealed Stainless Steel Bonnet**



**Stainless Steel Bonnet**

Bonnet Type	Size Range	Shell MOC	Handwheel MOC	Compressor MOC	Autoclavable	SIP	Chemical Resistance
Stainless Steel	DN15 - DN150 (½" - 6")	Stainless Steel	PES (Polyethersulphone)	Stainless Steel	✓	✓	✓
Para	DN15 - DN50 (½" - 2")	PARA (Polyaryl Amide)	PARA (Polyaryl Amide)	Stainless Steel		✓	✓
PES Performance	DN15 - DN80 (½" - 3")	PES (Polyethersulphone)	PES (Polyethersulphone)	Stainless Steel	✓	✓	✓
Stainless Steel Sealed	DN15 - DN80 (½" - 3")	Stainless Steel	Stainless Steel	Stainless Steel	✓	✓	✓
Bioseal Polymer	DN8 (¼")	PPS (Polyphenylene Sulphide)	PPS (Polyphenylene Sulphide)	Stainless Steel	✓	✓	✓
Bioseal Stainless Steel	DN8 (¼")	Stainless Steel	PPS (Polyphenylene Sulphide)	Stainless Steel	✓	✓	✓

Please visit [www.saundersdrawings.com](http://www.saundersdrawings.com) for current library of drawings in PDF, 2D DWG, and 3D STP formats.

# Diaphragm Valves Resilience Diaphragms

## Introduction

Saunders® develops, compounds and manufactures all single piece elastomer and 2 piece leaf style PTFE faced diaphragms in-house from raw ingredient and has front to back ownership of all phases of development and manufacturing.

## NEW! Type ER Resilience EPDM Diaphragm

Saunders® ER grade diaphragm is manufactured from a specially formulated EPDM compound. The ER material is peroxide cured for optimum cross linking and to minimize extractables and leachables.

### Key Features

1. Enhanced surface finish integrity to assist process purity (ASME BPE compliant)
2. Up to 40% improvement in compression set characteristic compared to typical EPDM diaphragms to reduce need for re-torque and ensure seal to atmosphere
3. Excellent chemical resistance to typical Biopharm process media
4. Front to back technology ownership optimizes security & reliability

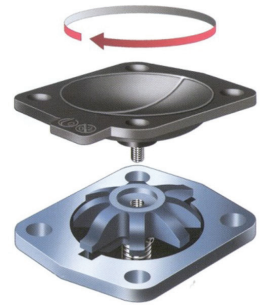

The ER diaphragm uses the Saunders® threaded compressor attachment for easy “error free” engagement of diaphragm and compressor.

## Type PR PTFE/EPDM Diaphragms

### Key Features

1. 100% virgin PTFE product contact face which is inert and unaffected by media common to bio-process applications
2. Industry conforming low levels of extractables and leachables
3. Fabric reinforced EPDM backing

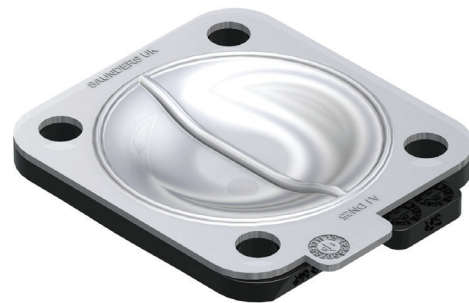

## Type SR TFM/EPDM Diaphragms

### Key Features

1. Reduction in cold flow deformation typically associated with conventional PTFE components present in BioPharm systems
2. Improved performance under aggressive steam sterilization and pure water-based media
3. Fabric reinforced EPDM backing

Saunders® SR and PR diaphragms feature the Saunders® bayonet type compressor attachment which allows the diaphragm to float freely relative to compressor to avoid point loading of the TFM at the stud. The bayonet fit also facilitates easy error free engagement of diaphragm and compressor.

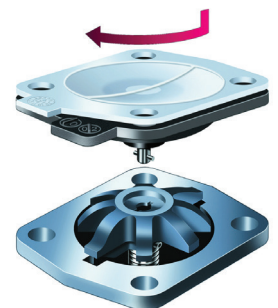

**PTFE Type Diaphragm**

Please visit [www.saundersdrawings.com](http://www.saundersdrawings.com) for current library of drawings in PDF, 2D DWG, and 3D STP formats.

# Diaphragm Valves **Elastomer Diaphragms**

## Elastomer Diaphragms

The Saunders<sup>®</sup> diaphragm is an intricate design and not a simple injection molded part. Layers of proprietary blended and calendared (rolled into sheet form) rubber is vulcanized with high strength woven reinforcement.

### Type EE Grade EPDM Diaphragms

The EE grade diaphragm is constructed from Ethylene propylene diene monomer (EPDM) base polymer. Originally developed to meet BioPharm customer requirements for an EPDM grade, this diaphragm has demonstrated excellent performance on the full range of bio-process applications. The EE grade diaphragm has full industry compliance. Available post cured variation designated as grade EF.

### Type 500 Grade Silicone Diaphragms

The 500 grade diaphragm uses a dicumyl cured silicone that is fabric reinforced to optimize flex life. This is a white grade of diaphragm which offers very low levels of extractables and leachables. Silicone is ideal for low temperature environments and applications. Like all Life Science Diaphragms, the 500 grade Silicone Diaphragm is FDA conforming and USP Class VI tested and certified.

### Type PV Grade Passivation Diaphragms

The Saunders PV passivation diaphragm has been developed specifically for use during the passivation of stainless steel systems reducing installation and set up costs for the end user.

#### Key Features

- 1 Reduced cost versus single use PTFE diaphragm
- 2 High visibility tag reduces risk of diaphragm not being replaced
- 3 100% interchangeable with Saunders Life Science PTFE diaphragm range



**PV Passivation Diaphragm**

**PV Passivation Diaphragm Installed on Valve**

**Diaphragm Build-up**

### Type 425 Grade EPM Diaphragms

Manufactured from inherently stable EPM (a copolymer of Ethylene and Propylene monomers)

#### Key Features

- 1 Organic peroxide-cured for reduced extractables and leachables
- 2 Enhanced temperature performance and chemical resistance due to fully saturated hydrocarbon backbone with no double bonds
- 3 Available post cured variation designated as grade E3

Please visit [www.saundersdrawings.com](http://www.saundersdrawings.com) for current library of drawings in PDF, 2D DWG, and 3D STP formats.

Crane ChemPharma & Energy  
Crane Process Flow Technologies Ltd.  
Grange Road  
Cwmbran, Gwent NP44 3XX  
UNITED KINGDOM  
Tel: +44 163 348 6666  
Fax: +44 163 348 6777  
www.cranecpe.com

**CRANE**<sup>®</sup>

Crane Process Flow Technologies  
SPRL / BV  
Avenue Franklin No. 1  
Wavre, B-1300 , Belgium  
Tel: +32 10 8184 44  
Fax: +32 10 8184 58

Crane Process Flow Technologies (India) Ltd  
Solitaire, 5th & 6th Floor, S.No. 131 / 1+2 ,  
ITI Road, Aundh, Pune - 411007, India  
Tel: +91 20 3056 7800  
Fax: +91 20 3056 7812

Saunders<sup>®</sup> Sales Office  
9860 Johnson Road  
Montgomery, Texas 77316  
Tel: +1 936 588 8360  
Fax: +1 936 588 8302

**brands you trust.**



**COMPAC-NOZ**<sup>®</sup>



**DEPA**<sup>®</sup>

**ELRO**<sup>®</sup> **Duo-CHEK**<sup>®</sup>



**NOZ-CHEK**<sup>®</sup>



**RESISTOFLEX**<sup>®</sup>



**STOCKHAM**<sup>®</sup>

**UNI-CHEK**<sup>®</sup>

**WESTLOCK**  
CONTROLS

**w.ta.**<sup>®</sup>

**XOMOX**<sup>®</sup>

Crane Co., and its subsidiaries cannot accept responsibility for possible errors in catalogues, brochures, other printed materials, and website information. Crane Co. reserves the right to alter its products without notice, including products already on order provided that such alteration can be made without changes being necessary in specifications already agreed. All trademarks in this material are property of the Crane Co. or its subsidiaries. The Crane and Crane brands logotype, in alphabetical order, (ALOYCO<sup>®</sup>, CENTER LINE<sup>®</sup>, COMPAC-NOZ<sup>®</sup>, CRANE<sup>®</sup>, DEPA<sup>®</sup>, DUO-CHEK<sup>®</sup>, ELRO<sup>®</sup>, FLOWSEAL<sup>®</sup>, JENKINS<sup>®</sup>, KROMBACH<sup>®</sup>, NOZ-CHEK<sup>®</sup>, PACIFIC VALVES<sup>®</sup>, RESISTOFLEX<sup>®</sup>, REVO<sup>®</sup>, SAUNDERS<sup>®</sup>, STOCKHAM<sup>®</sup>, UNI-CHEK<sup>®</sup>, WESTLOCK CONTROLS<sup>®</sup>, WTA<sup>®</sup>, and XOMOX<sup>®</sup>) are registered trademarks of Crane Co. All rights reserved.