

brands you trust.

Installation, Operation and Maintenance Manual
Saunders[®] M-VUE
Intelligent Sensing Technology



Table of Contents

Basic Safety Instructions	3
Scope of Supply	4
Overview	5
Basic Installation Guide	6-10
Mounting the Solenoid Valve	8
Mounting M-VUE to an Actuator	9
Solenoid Valve Pneumatic Connections	10
Calibration	11-15
Integral Solenoid	12
Remote Solenoid	13
AS-Interface	14
DeviceNet	15
Point-to-Point Wiring	16
AS-Interface (AS-i)	17-19
Wiring	17
Communication Bits	18
Addressing	19
DeviceNet	20-24
Wiring	22
Communication Bytes	23
Setting Address on DeviceNet Units Only	24
Using the M-VUE Menus	25-28
Technical Data	29
Troubleshooting: Alarms	30
Dimensions	31

Basic Safety Instructions

These instructions do not make allowance for:

- Contingencies and events which may arise during the installation, operation, and maintenance of the sensor.
- Local safety regulations; the operator is responsible for observing these regulations, also with reference to the installation personnel.

High Pressure

Before removing pneumatic lines and valves, turn off the pressure and vent the lines. To prevent damage, make sure that all the pneumatics connections are made correctly.

Electrical Risks

Before working on the sensor, switch off the power supply and prevent reactivation. Observe applicable accident prevention and safety regulations for electrical equipment.

Hazardous Situation

To avoid injury, ensure:

- That the system cannot be activated unintentionally.
- Installation and maintenance may be carried out by authorized technicians only.
- After an interruption in the power or pneumatic supply, ensure that the process will be restarted in a defined and controlled manner.
- The sensor must be operated according to the operating instructions

Warning:

Do not connect or disconnect while circuit is live unless location is known to be non-hazardous.

Scope of Supply

*A full range of additional accessories and spares are available from Saunders[®] on request.
Please contact us for more information*



Sensor Electronics Module



Sensor Mounting Base



Magnetic Target with
visual indicator



Exhaust Block
(optional)



Spare Magnetic Key



3/2 Integral Solenoid (optional)



Solenoid Cover
(optional)



Cable
(optional)

Overview

Magnetic Buttons
H1 and H2 to allow
configuration with
the magnetic key

Mechanical position
indicator

Ring of super
bright LEDs
(Indicate valve
position)

Magnetic button
connection indication

Optional
solenoid
valve

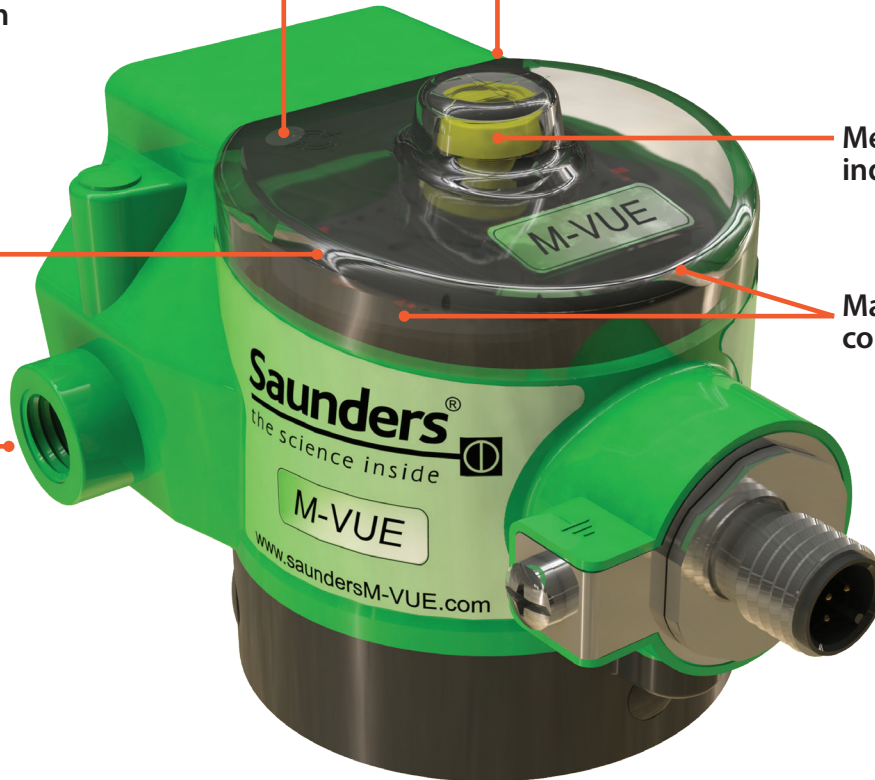

Magnetic key for use with H1
and H2 magnetic buttons

Basic Installation Guide

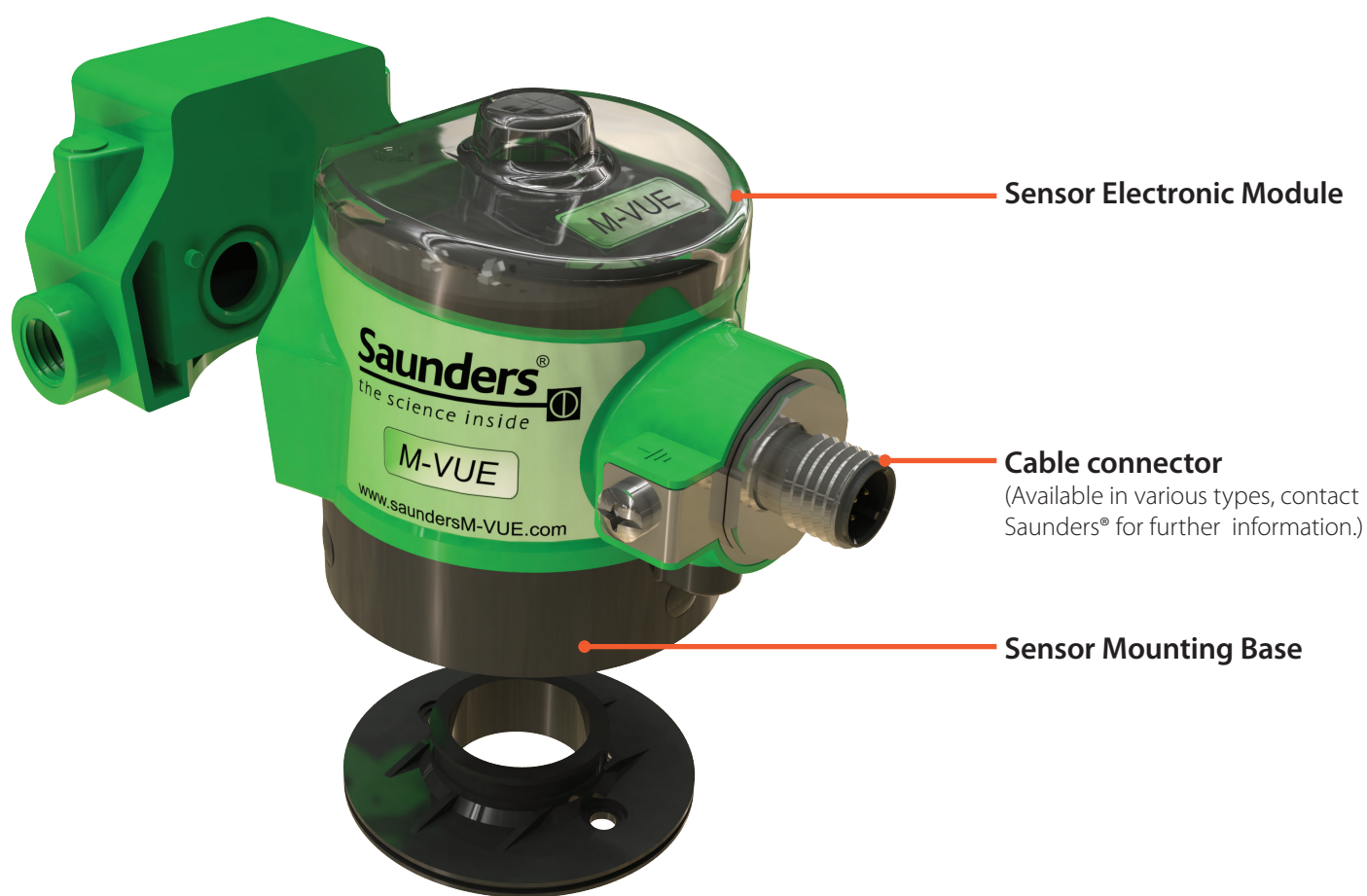

Basic Installation Guide

Check that the M-VUE
model number is correct for
the application



PRODUCT TYPE	COMMUNICATION TYPE	CONNECTION TYPE	SOLENOID TYPE	OPTIONAL EXHAUST
M-VUE = M-VUE	2E2 = Point to Point	V15= M12 5-Pin	+ SC = No Solenoid	+E = Exhaust with 1/8" NPT
	ASI 3.1 = ASi v2.0 Profile 70	V1 = M12 4-Pin	+ BM-V = 1/8" NPT	+ES= Exhaust with 1/8" BSP
	ASI 3.1A = ASi v2.0 Profile 7H		+ BM-VS = 1/8" BSP	
	ASI 3.2 = ASi v2.1			
	ASI 3.3 = ASi v 3.0			
	DNC = DeviceNet	VM = 7/8" 5-Pin		
			V15= M12 5-Pin	

EXAMPLE: M-VUE-DNC-VM + BM-V + E

MEANING: M-VUE Sensor with DeviceNet, 7/8" 5 Pin connector, 1/8" NPT Solenoid Valve and 1/8" Exhaust NPT Block

Note: Configurations are dependent upon communication type, network protocol etc. Contact Saunders[®] for more information

Basic Installation Guide **Mounting the Solenoid Valve**

Tools Required:

- Philips or Flat head screwdriver 8 mm open ended spanner to suit air fittings.
- Low strength threadlock adhesive (recommended)
- Thread sealing compound for pneumatic fittings (if required)

Note: For actuators that require a mounting kit. Please contact Saunders for the relevant installation procedure

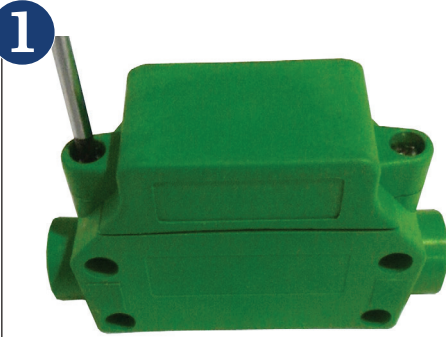

Remove the plastic solenoid cover by loosening the two screws that secure it to the pneumatic body.

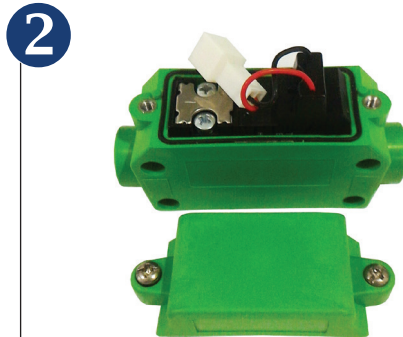

Remove the two screws securing the coil and pull the entire assembly out.

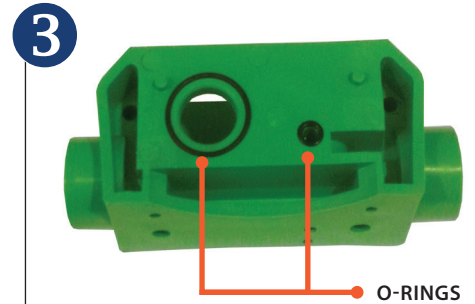

Make sure the two O-rings are attached to the side of pneumatic case. (This will avoid contamination and any air leakage.)

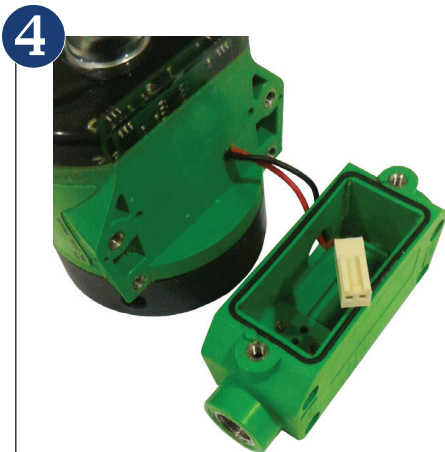

Insert the electrical connector from the sensor into the larger orifice of the pneumatic case.

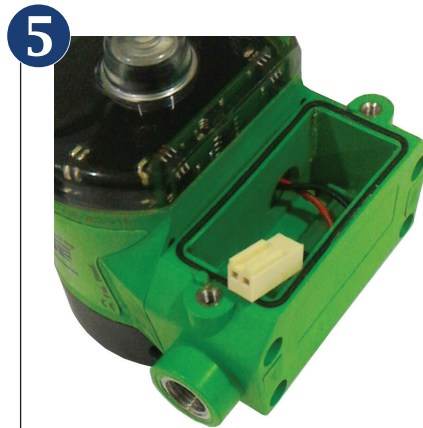

Attach the pneumatic case to the electronics module with the four fastening screws provided.

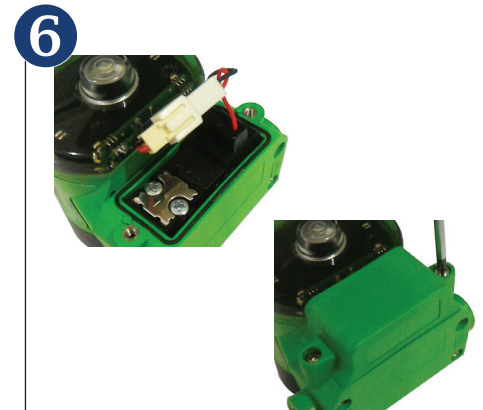

Re-attach the coil to the pneumatic case and tighten the two fastening screws. Connect the two cables (electronic sensor and the coil). Replace the solenoid cover and tighten the screws

Basic Installation Guide Mounting M-VUE to an Actuator

1



Loosen the three captive screws from the electronics module and undock the mounting base

2

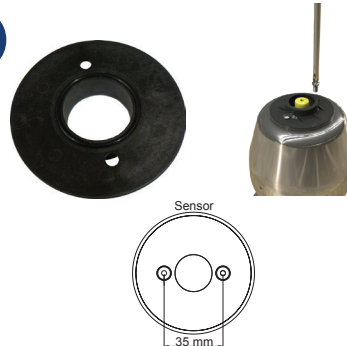

Install the enclosed O-ring to the mounting base and attach it to the top of the actuator. The plate will fit directly to Saunders actuators with a separation of 35mm at the top. Other actuators or distances will require an additional adapter plate.

3



Screw fix the Magnetic Target with Visual Indication to the actuator. We recommend any low strength threadlock adhesive.

4



Re-attach sensor electronics module to the sensor mounting base. At this point verify the mechanical indicator displays the correct position

5



The yellow indicator should be fully visible when the aseptic valve is OPEN. If additional adjustments are necessary adjust the height of the yellow indicator knob until the OPEN position is visible.

6



After adjustments have been completed tighten the three captive screws at the base of the sensor



7

Connect any air fittings and tube to the actuator (and M-VUE solenoid if integral solenoid is fitted)
Note: Supply pressure not to exceed 8 bar (116 PSI)

8

Once power supply is provided to M-VUE, it will perform self-check to indicate valve position. After self check the LEDs indicate the valve position and factory settings for the sensor are unchanged.

Optional Exhaust Port Block

M-VUE can be equipped with an optional exhaust block if air used by pneumatic actuator needs to be ported out of a classified area.

Make sure the O-ring provided with the block is installed correctly between the pneumatic case and the exhaust block in order to avoid any air leakage. Use the three enclosed screws to secure the block to the case.

Basic Installation Guide Solenoid Valve Pneumatic Connections

The size of the pneumatic connections offered are 1/8" NPT or BSP. Internal connection bays are Stainless Steel reinforced.

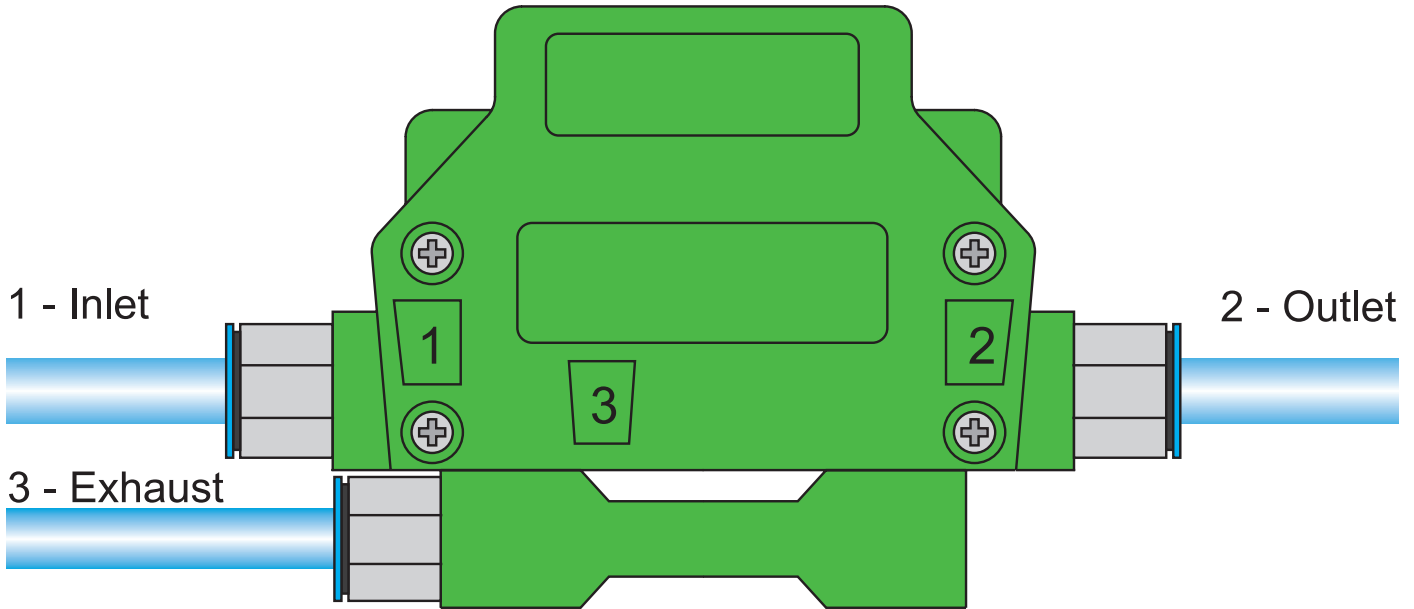

Note: The exhaust block is optional and must be ordered separately.

1. Inlet Pressure Port 1: Connection to main air supply
Note: Supply pressure not to exceed 8 bar (116 PSI)
2. Outlet Pressure Port 2: Connection to pneumatic actuator
3. Exhaust Port 3: Air consumed by the actuator exits out of Port 3 to the environment. Warning: Do not block the port orifice as it may interfere with normal operation.
4. Note: Picture shows optional exhaust port block that may be used to channel air out of classified area

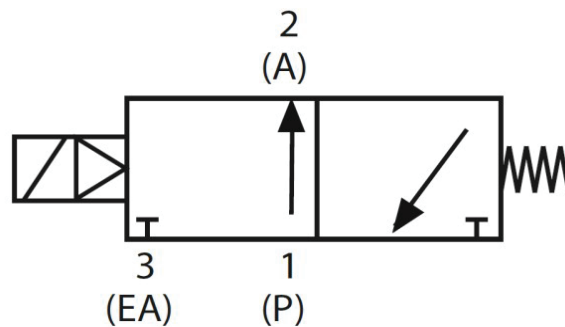

Calibration

Calibration and Setting Options

The features of M-VUE are dependent on both the network/communication protocol and the use of integral or remote solenoid.

The table below outlines the possibilities of each of the M-VUE network protocols

Feature		P2P		AS-Interface		DeviceNet	
		Integral Solenoid	Remote Solenoid	Integral Solenoid	Remote Solenoid	Integral Solenoid	Remote Solenoid
Self-Calibration	At the sensor (Locally)	Yes	No	Yes	Yes	Yes	Yes
	Remote (DCS or PLC)	No	No	Yes	Yes	Yes	Yes
Address Device	At the sensor (Locally)	No	No	No	No	Yes	Yes
	Remote (DCS or PLC)	No	No	Yes	Yes	Yes	Yes
Programming M-VUE	At the sensor (Locally)	Yes	Yes	Yes	Yes	Yes	Yes
	Remote (DCS or PLC)	No	No	Yes	Yes	Yes	Yes
Alarm Diagnostics	At the sensor (Locally)	Yes	Yes	Yes	Yes	Yes	Yes
	Remote (DCS or PLC)	No	No	Yes	Yes	Yes	Yes

Description of LEDs

LED Functions:

- P1: Self Calibration
- P2: Hand Calibration
- P3: Solenoid Option
- P4: Output Inversion
- P5: Led Inversion
- P6: Factory Reset
- H1 Led: Light blue (when magnetic key is present)
- H2 Led: Light blue (when magnetic key is present)
- Power Led:
 - Light green when power is applied to sensor
- AS-Interface and DeviceNet versions:
 - Blinking green: Not allocated
 - Light red: No communication established
 - Blinking green/red: Peripheral failure

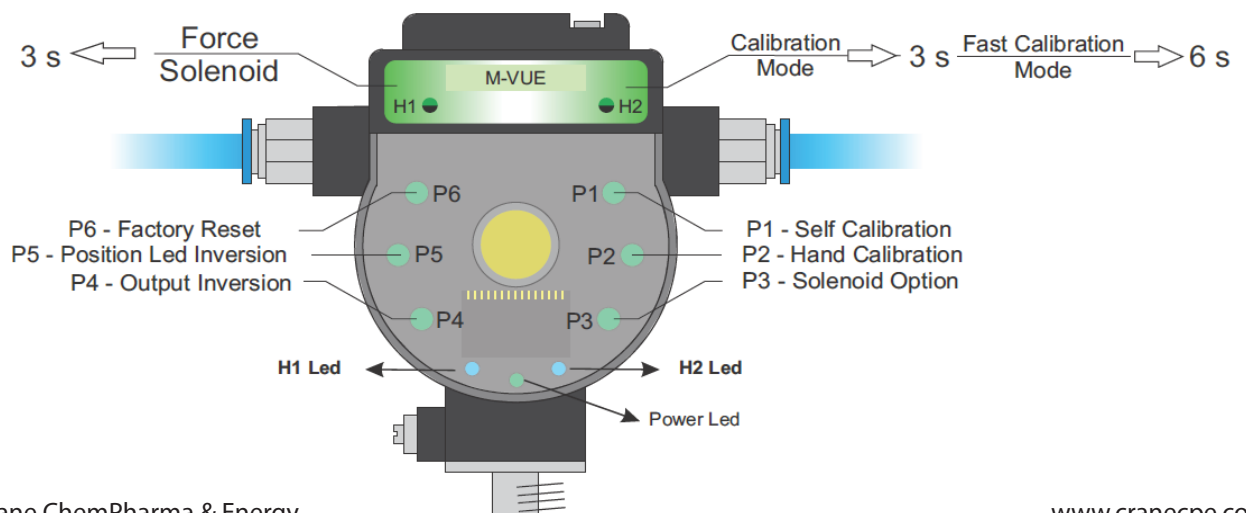

Calibration Integral Solenoid

Forcing the Integral Solenoid

1. To energize solenoid valve, hold the magnetic key over H1 for 3 secs. This will operate the actuator.
2. To de-energize the solenoid hold the magnetic key over H1 for 3 sec. The actuator moves to the fail-safe position



Self Calibration (Integral Solenoid)

Note: this guide only details self-calibration process for a sensor with integral solenoid at the sensor.

For calibration via a network, please refer to the corresponding network section of this manual.

1. Hold the magnetic key over H2 for 6 seconds. The P1 LED indicator will turn green. M-VUE will automatically perform a self-calibration routine. It will automatically open and close 3 times.
2. If the self calibration routine is successful all the LEDs will flash green for 2 seconds and M-VUE will return to normal run mode
3. If the self calibration routine fails all LEDs will flash red for 2 seconds. P1 will remain flashing waiting for confirmation to try another calibration.

Note: If the calibration fails, the last successful calibration will remain stored at the sensor.

6 s to confirm Self Calibration

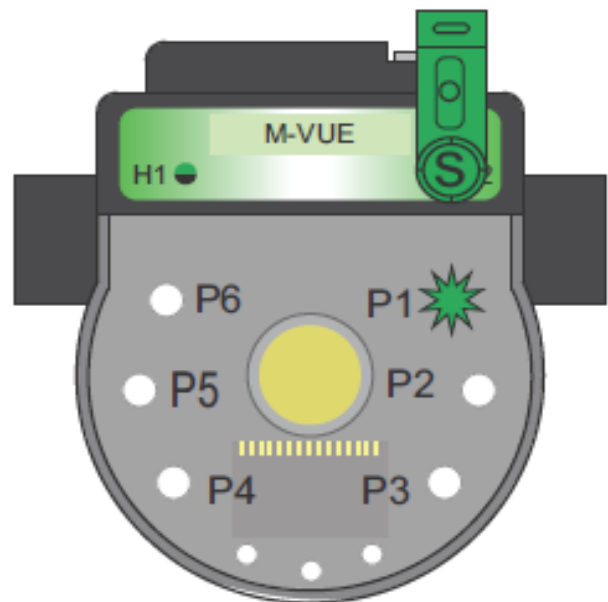

Hand-Calibration Remote Solenoid

**3 Seconds to Confirm
Hand Calibration**

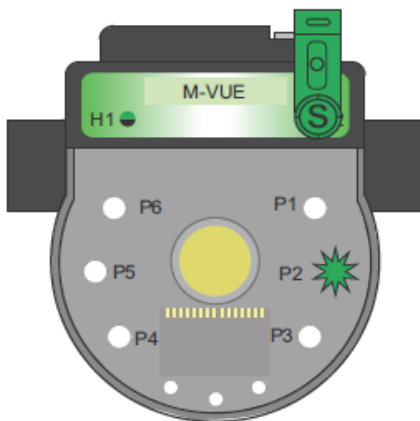

Asking for Close

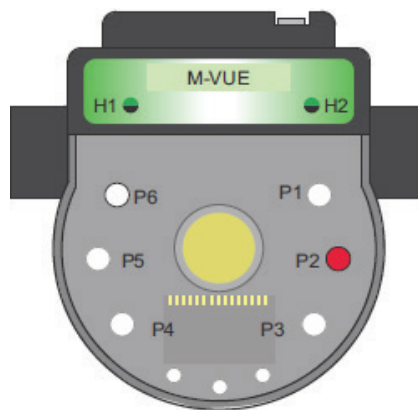

Asking for Open

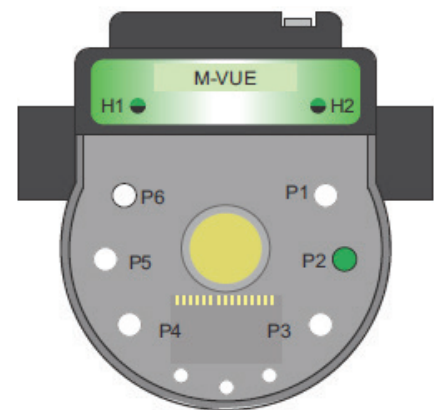

1. Hold the magnetic key over H2 for 3 seconds . The ring of LED's will flash green for 2 seconds (this indicates Configuration Mode has been accessed)
2. Hold the magnetic key over H1 to select the Hand Calibration Mode (P2 LED must be flashing)
3. Confirm the selection of P2 by holding the magnetic key over H2 for 3 seconds
4. P2 LED will light red. This is indication that the aseptic valve is in the CLOSED position. Confirm the CLOSED position by holding the magnetic key over H2
5. P2 LED will light green. This is indication that the aseptic valve needs to be OPEN position. Confirm the OPEN position with the magnetic key over H2.
6. To exit the configuration mode hold the magnetic key over H1 for more than 3 seconds or wait 30 seconds without approaching any magnetic key to either H1 or H2 buttons

Calibration AS-Interface

Calibration with Integral Solenoid (AS-Interface)

Self-Calibration of the M-VUE is controlled by Output Bit 2 on AS-Interface networks. By changing Output Bit 2 from 0 to 1, the M-VUE unit can perform its self-calibration cycle. The self-calibration sequence is automatic and will cycle the aseptic valve three times.

Output Bits			
Bit 3	Bit 2	Bit 1	Bit 0
	Self-calibration		Solenoid command

Note: In order to perform a successful calibration after 3 seconds Bit 2 must be changed from 1 to 0, otherwise the system will attempt to self-calibrate continuously.

Warning: Self-Calibration will perform valve cycling and thus care must be taken as the valve will move.

Calibration with External Solenoid (AS-Interface)

M-VUE can operate a remote solenoid to cycle a pneumatic actuator and remote calibrate the corresponding aseptic valve.

- By changing Output Bit 2 from 0 to 1, the M-VUE unit can perform its self-calibration cycle.
- Input Bit 3 must be used to command a signal to control a remote solenoid.
 - Value 0 is used to de-energize a remote solenoid
 - Value 1 is used to energize a remote solenoid

The self-calibration sequence is automatic and will cycle the aseptic valve three times

Output Bits			
Bit 3	Bit 2	Bit 1	Bit 0
	Self-calibration		Solenoid command

Input Bits			
Bit 3	Bit 2	Bit 1	Bit 0
External Solenoid Command	Calibration Status	Closed Position	Open Position

Note: In order to perform a successful calibration after 3 seconds Output Bit 2 must be changed from 1 to 0, otherwise the system will not self-calibrate

Warning: Self-Calibration will perform valve cycling and thus care must be taken as the valve will move

Calibration DeviceNet

Calibration with Integral Solenoid (DeviceNet)

Self-Calibration of M-VUE is controlled by Output Byte 1, Bit 2 on DeviceNet networks

By changing Bit 2 from 0 to 1, the M-VUE unit can perform its self-calibration cycle.

Output Byte 1							
Bit 7	Bit 6	Bit 5	Bit 4	Bit 3	Bit 2	Bit 1	Bit 0
			Factory Reset		Self Calibration		Solenoid Command

Note: In order to perform a successful calibration after 3 seconds Bit 2 must be changed from 1 to 0

Warning: Self-Calibration will perform valve cycling and thus care must taken as the valve will move

Calibration with External Solenoid (DeviceNet)

M-VUE can control a remote solenoid to cycle a pneumatic actuator and perform remote calibration.

- By changing Output Byte 1, Bit 2 from 0 to 1, the M-VUE unit can perform its self-calibration cycle.
- Input Byte 1, Bit 4 must be used to command a signal to control a remote solenoid.
 - Value 0 is used to de-energize the remote solenoid
 - Value 1 is used to energize the remote solenoid

The self-calibration sequence is automatic and will cycle the aseptic valve for three cycles.

Output Byte 1							
Bit 7	Bit 6	Bit 5	Bit 4	Bit 3	Bit 2	Bit 1	Bit 0
			Factory Reset		Self Calibration		Solenoid Command

Input Byte 1							
Bit 7	Bit 6	Bit 5	Bit 4	Bit 3	Bit 2	Bit 1	Bit 0
		Common Alarms	External Solenoid Command	Calibration Status	Solenoid Forced at the sensor	Open position	Closed position

Note: In order to perform a successful calibration after 3 seconds Output Bit 2 must be changed from 1 to 0, otherwise the system will not self-calibrate

Warning: Self-Calibration will perform valve cycling and thus care must taken as the valve will move

Point-to-Point Wiring

Pin Configuration

Pin	Wire Colour	Designation
1	Brown	24 V dc (+)
2	White	Output 1
3	Blue	24 V dc (-)
4	Black	Output 2
5	Yellow	Solenoid

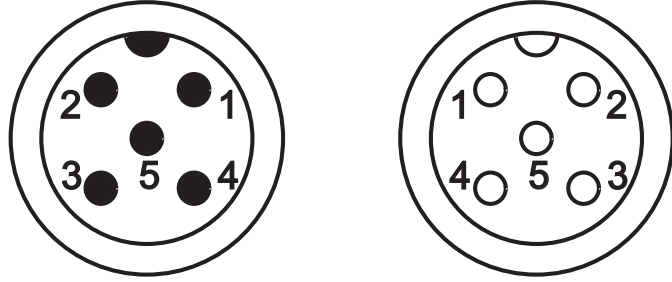

Note: Units without integral solenoid only have 4-pins

Output 1 indicates when the valve is CLOSED and sends this signal to the PLC input card. Output 2 indicates when the valve is OPEN and sends this signal to the PLC input card. These outputs can be reversed in the "Output Option" within the M-VUE menu

Wiring Diagram

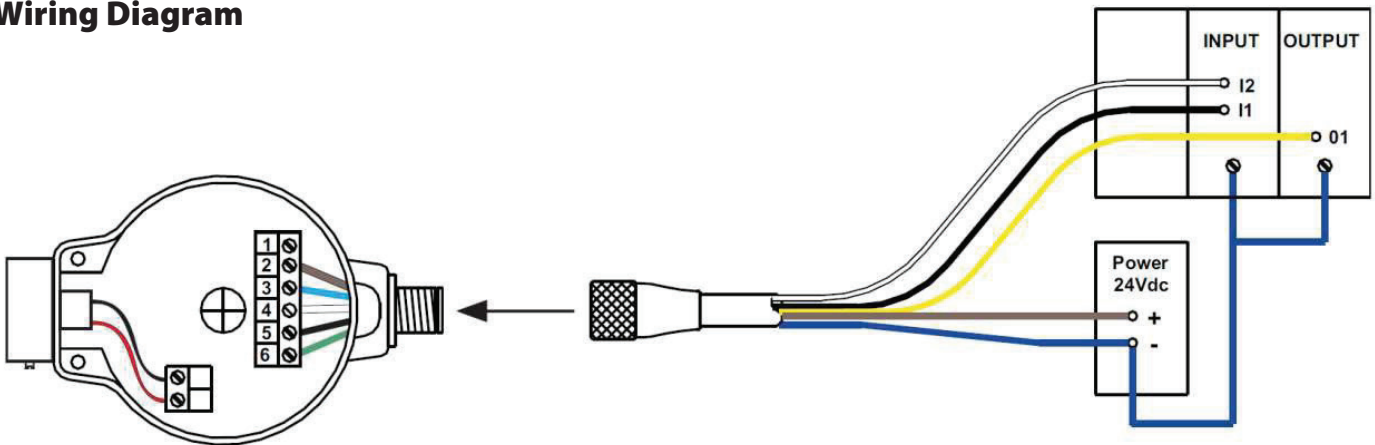

Note: For units without integral solenoid, pin 5 is not active. To bypass the integral solenoid (to use a panel mounted solenoid) the pin 5 (yellow wire) is isolated or connected to the negative 24dc (pin 3) terminal.

Note: The wiring configurations and colours in this manual relate to Saunders supplied cables only. If alternative cables are used, ensure the correct wire relates to the correct pin.

AS-Interface (AS-i) Wiring

Pin Configuration

Pin	Wire Colour	Designation
1	Brown	AS-i (+)
2	Blue	AS-i (-)

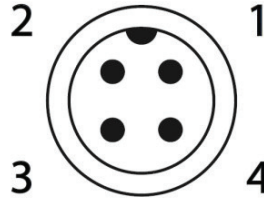

Sensor Connector - Male

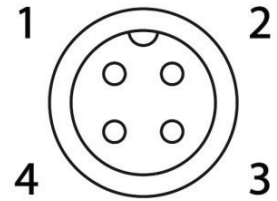

External Connector - Female

Wiring Diagram

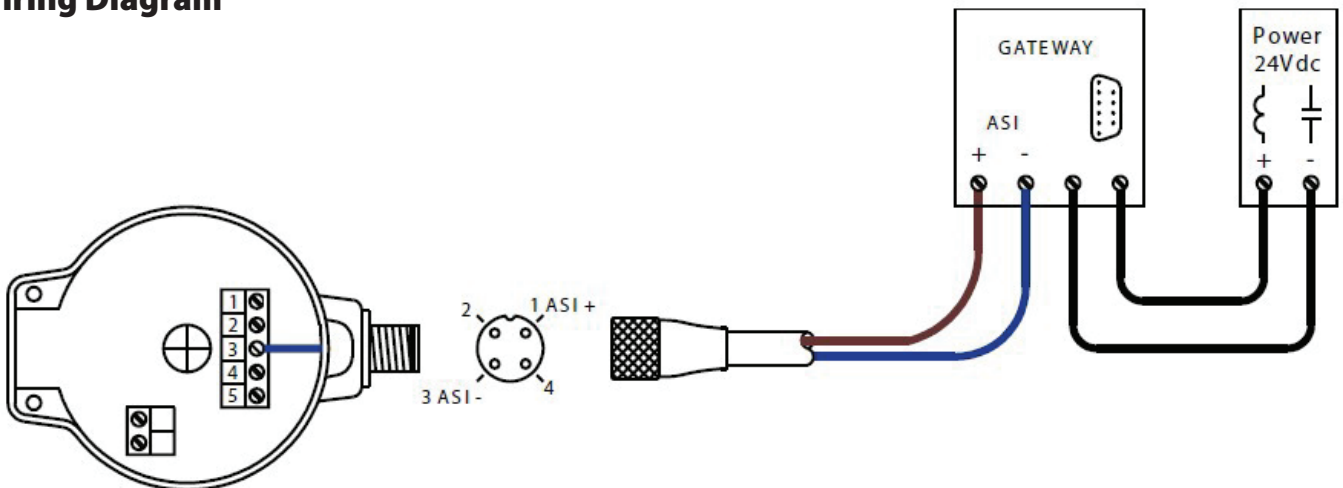

AS-Interface (AS-i) Communication Bits

AS-Interface Communication Bits

Input Bits				Meaning
Bit 3	Bit 2	Bit 1	Bit 0	
		0	0	In the middle of the way
		1	0	Valve Open
		0	1	Valve Closed
		1	1	Not Used
	0			Successful Calibration-Run Mode
	1			Self Calibration Mode Active (Stay in '1' if Self Calibration Fail)
0				M-VUE Asks External Solenoid: OFF
1				M-VUE Asks External Solenoid: ON

Output Bits			
Bit 3	Bit 2	Bit 1	Bit 0
	Self-calibration		Solenoid command

Output Bit 0 – when changed from 0 to 1, the solenoid is activated

Output Bit 2 - when changed from 0 to 1, the sensor starts self-calibration.

Note: In order to perform a successful calibration after 3 seconds bit 2 must be changed otherwise the sequence will not work.

Warning: Self-Calibration will perform valve cycling and thus care must taken as the valve will move.

AS-Interface (AS-i) Addressing

Addressing the Saunders® M-VUE

Addressing the M-VUE can be performed with a standard AS-i Handheld programmer or by network configuration software. The number of addresses depends on the AS-i version.

The default address for M-VUE is 0.

I/O and ID Parameters

I/O Code - is a hexadecimal code recorded on the AS-i chip, and determines a code to indicate the number of inputs and outputs of the slave.

ID Code - This code also hexadecimal indicates a number of specifications and functions of the slave, called the PROFILE and is also standardized by the AS- Interface association.

AS-Interface Versions

The sensor can be supplied in four versions:

M-VUE Code	ASi Version	I/O	ID	ID1	ID2	Address
ASI3.1	ASI v2.0 Std address	7h	0h	Fh	Fh	70F2
ASI3.2	ASI v2.1 Ext address	7h	Ah	Fh	7h	7AF7
ASI3.3	ASI v3.0 Ext address	7h	Ah	Fh	7h	7AF7
ASI3.1	ASI v2.0 Std address*	7h	Fh	Fh	Fh	FFF7h

* Replacement profile for existing installations

DeviceNet

DeviceNet System Topography

The Saunders® DeviceNet M-VUE can be utilised with the following system topographies:

- Branch Line
- Tree
- Line

The Saunders® DeviceNet M-VUE can not be utilised with the following system topographies:

- Star
- Ring

DeviceNet System Cabling

Thick Cable

The DeviceNet thick cable is also known as a Trunk Cable. It has an external diameter of 12.5 mm, with a PVC cover or in special cases a PU cover. You can also use this cable for drop lines. Excessive bending of this cable can reduce its ability to meet DeviceNet requirements. The power rating is normally 8A. Because of its diameter this cable has limited flexibility and can be difficult to install in some circumstances.

Thin Cable

The DeviceNet thin cable is also known as a Drop Cable. It has an external diameter of 7mm, with a PVC cover or in special cases PU cover. Due to the smaller diameter the thin cable is more flexible than thick cable, but care must be taken with cable installation.

Cable Lengths

The table below shows the maximum cable length according to the communication (transmission) rate adapted to the network. For long distances the inductance and distributed capacitance is greater and reduces the digital communication signal:

Cable Type	Cable Function	Transmission Rate		
		125 kbits/s	250 kbits/s	500 kbits/s
Thick Cable	Trunk	500 m	250 m	100 m
Thin Cable	Trunk	100 m		
Thin Cable	Derivation	6 m		
Thin Cable	S Derivation	156 m	78 m	39 m

DeviceNet

DeviceNet Termination Resistor

At the extremes of the network a termination resistor must be installed, which has the objective of reducing possible signal reflections on the network. These can cause disturbances in communication, with constant and random stops and eventually total interruption of operation.

The terminating resistor must be 121 Ω , but it is assumed to have the commercial value of 120 Ω with a required minimum power dissipation of $\frac{1}{4}$ W.

Terminating Resistor Connection

The 120 Ω resistor should be connected between the communication wires (CAN_H and CAN_L) at the two distribution boxes at the ends of the network, at the points that have the largest distance from each other.

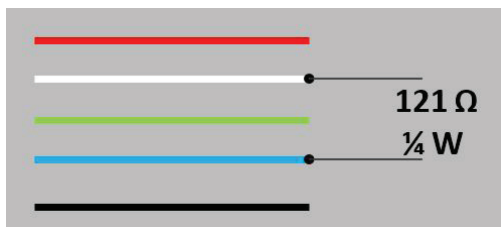

A practical way to verify if a network has been terminated correctly is measure the resistance between the communication wires blue and white, if the result is approximately 60 Ω this indicates that the resistors are present on the network.

DeviceNet Communication

Setting the Address

The address can be set in 3 ways - by the software configuration, via handheld or by the menu on the M-VUE unit. M-VUE can be addressed from 00 to 63.

To set the address at the M-VUE unit, please see "Setting the Address" section.

Note: M-VUE cannot have the same address as other network equipment, if this occurs the equipment with the same address will not work.

After setting the address, the user must set the rate at which the M-VUE will communicate in the network.

Baud Rate

The Baud Rate can be set to 125, 250 or 500 Kbit/s.

To set the baud rate at the M-VUE unit, please see setting "Setting the Speed/Baud Rate" section.

The communication rate must be set to be the same as that used by other equipment in the network.

DeviceNet Wiring

Pin Configuration

Pin	Wire Colour	Designation
1	Bare/Drain	GND
2	Red	24 V dc (+)
3	Black	24 V dc (-)
4	White	CAN_H
5	Blue	CAN_L

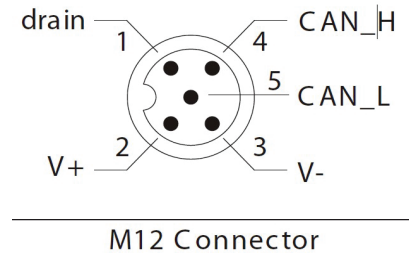
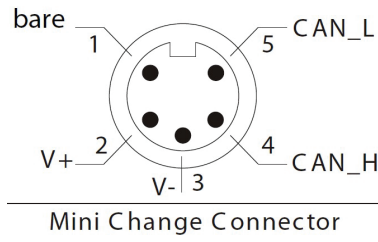

Wiring Diagram

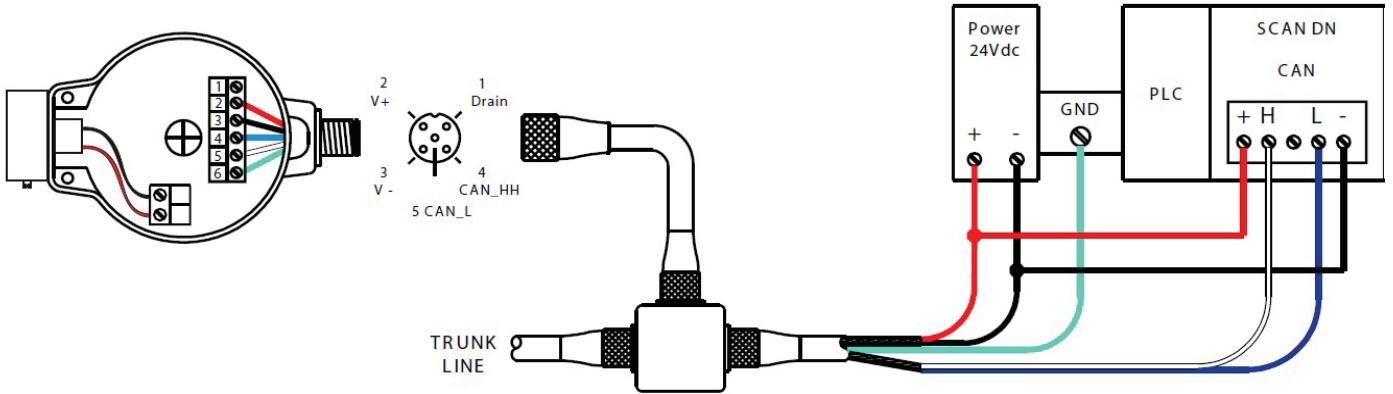

DeviceNet Communication Bytes

Communication Bytes

Input Byte	Input Bits								Meaning
	7	6	5	4	3	2	1	0	
1							0	0	Valve in Mid-Stroke Position
							0	1	Valve Closed
							1	0	Valve Open
							1	1	Not Used
						1			Solenoid is Forced (at Sensor)
					1				Self Calibration Status (1=Failed)
				0					Asking PLC ¹ to Power External Solenoid OFF
				1					Asking PLC ¹ to Power External Solenoid ON
			1						General Alarms
		X							Not Used
	X							Not Used	

Output Byte	Output Bits							
	7	6	5	4	3	2	1	0
1				Factory Reset		Self Calibration		Solenoid Command

Note 1: Use with external solenoid in self calibration mode.

Note 2: To use with external solenoid during Self Calibration Mode.

Note 3: The input bits in this table are factory default settings. If the output option is switched from nC to nO the input bit 1 and input bit 0 will be inverted. For more information see "Switching Output Options."

Note: In order to perform a successful calibration after 3 seconds Output Bit 2 must be changed from 1 to 0, otherwise the system will not self-calibrate.

Default Factory Settings and EDS Options

The Electronic Data Sheet (EDS) file is an electronic file that describes the operating and configuration parameters of the equipment, and is distributed by the manufacturer

The EDS file allows configuration of features and parameters at the master PLC or DCS.

The EDS parameters are outlined below:

ID	Parameter	Current Value
1	Self Calibration	YES, NO
2	Self Calibration Confirm.	OK, FAIL
3	Factory Reset	YES, NO

Visit www.SaundersM-VUE.com for the latest EDS files.

DeviceNet Addressing (DeviceNet Units Only)

This parameter allows the address of the M-VUE sensor to be set. The M-VUE can be addressed from 00 to 63. The DeviceNet sensor is equipped with LCD screen that will show Address and Baud Rate information.

Important! The M-VUE cannot have the same address as other network equipment, if this occurs, the equipment with the same address will not work. Once the address is set, the network speed (Baud rate) at which M-VUE will communicate in the network also needs to be set (See setting network speed/ baud rate).

1. Hold the magnetic key over H2 for 3 seconds.
The ring of LED's will flash green for 2 seconds.
(This indicates Configuration Mode has been accessed.)
2. All LEDs will flash for 2 seconds immediately after P1 will flash green.
Use H1 to select SET on the LCD screen.
-P1 and P6 LEDs will flash green.
3. Use H2 to select the DeviceNet address.
(The ONEs digit will flash.)
4. Use H1 to change the digits (0 to 9).
Use H2 to confirm the desired numeric value.
5. After the "units" digit has been set, the "TENS" digit will flash.
(Waiting to change or confirm the current value.)
6. Use H1 to change the digits (0 to 6).
Use H2 to confirm the desired numeric value.
7. To exit the configuration mode hold the magnetic key over H1 for more than 3 seconds.

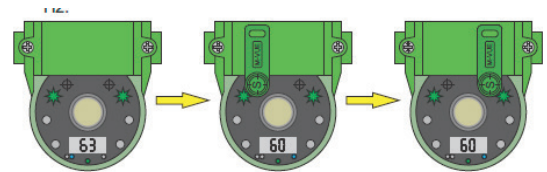
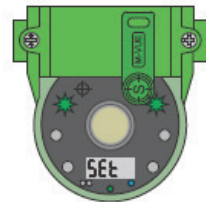
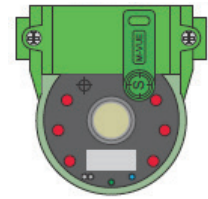

Note: Addressing of MVUE can also be performed remotely during valve commission form the control system (DCS or PLC)

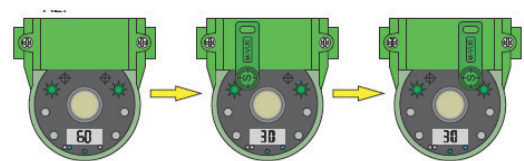

Using the M-VUE Menus

Overview

The Main Menu is accessed via the magnetic buttons H1 and H2 and is used to calibrate and program the sensor.

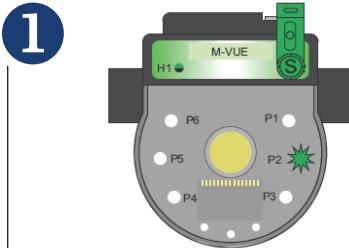

3 sec. to confirm hand calibration

Hold the magnetic key over H2 for 3 seconds. The ring of LED's will flash green for 2 seconds (this indicates Configuration Mode has been accessed)

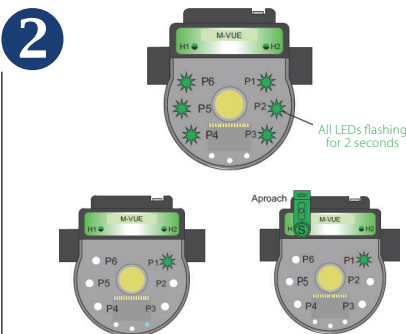

All LEDs flashing for 2 seconds

All LEDs will flash for 2 seconds immediately after P1 will flash green indicating Self Calibration Mode is active. Use H1 to select from the 6 available configuration modes:

- P1: Self Calibration
- P2: Hand Calibration
- P3: Solenoid Option
- P4: Output Inversion
- P5: LED Inversion
- P6: Factory Reset

3 To exit the configuration mode, hold the magnetic key over H1 for more than 3 seconds or wait 30 seconds without approaching any magnetic key to either H1 or H2 buttons.

Solenoid Option

The Main Menu is accessed via the magnetic buttons H1 and H2 and is used to calibrate and program the sensor.

1 Hold the magnetic key over H2 for 3 seconds. The ring of LED's will flash green for 2 seconds. (This indicates Configuration Mode has been accessed.)

2 All LEDs will flash for 2 seconds immediately after P1 will flash green. Use H1 to select

- P3: Solenoid Option

3 Once P3 has been selected hold the magnetic key over H2 to access the two available options and use H1 to select the desired option:

- P3 LED lights red and green: integrated solenoid option.
- P3 LED light green: external or remote solenoid option

4 After H2 has been used to confirm the desired option the LEDs will flash green for 2 seconds indicating the new configuration has been accepted.

3 sec. to confirm hand calibration

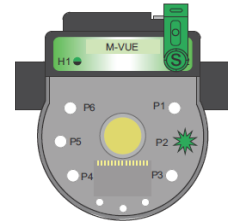

Approach

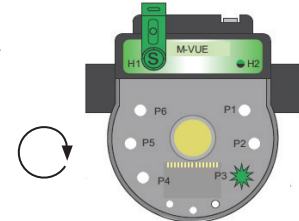

Confirm on H2

Integrated solenoid option



Change to External Solenoid

Confirm on H2

External solenoid option

External solenoid option

Using the M-VUE Menus

Solenoid Option

(Steps 5 and 6 are active only when external solenoid is chosen.)

The Main Menu is accessed via the magnetic buttons H1 and H2 and is used to calibrate and program the sensor.

5 Once the external solenoid option has been chosen, use H1 to highlight P5 and select the type of actuator (use P3 as a reference). Use H2 to enter the menu and then H1 to select the actuator type:

- P3 Lights red and green for Fail Closed actuators
- P3 Lights green for Fail Open actuators

Once a selection has been made confirm with H2 (LEDs will flash green for 2 seconds)

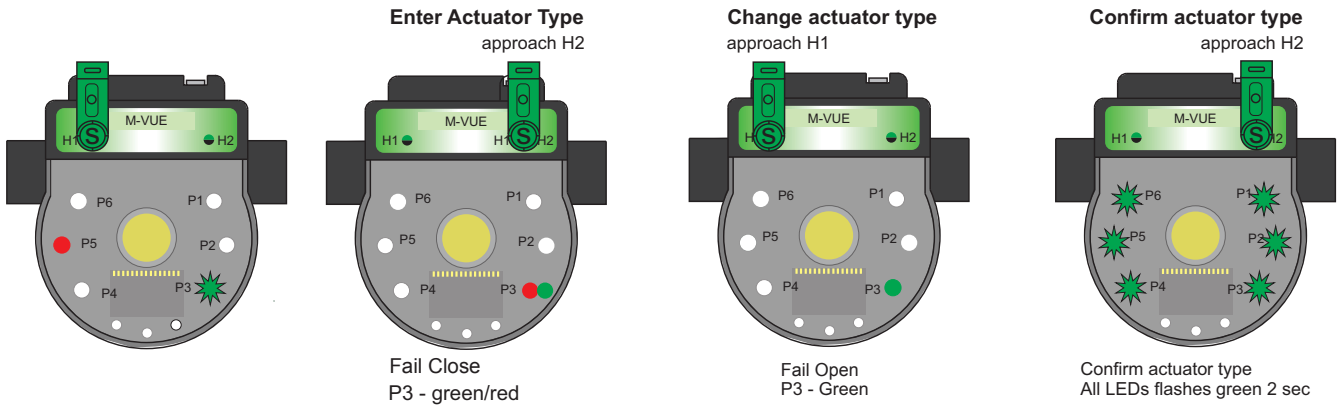

6 Alarm 1 can be enabled or disabled using H1 to highlight P4 and select the alarm option (use P3 as a reference). Use H2 to enter the menu and then H1 to select the option:

- P3 Lights red and green to activate solenoid Alarm 1
- P3 Lights green to disable solenoid Alarm 1

Once a selection has been made confirm with H2 (LEDs will flash green for 2 seconds)

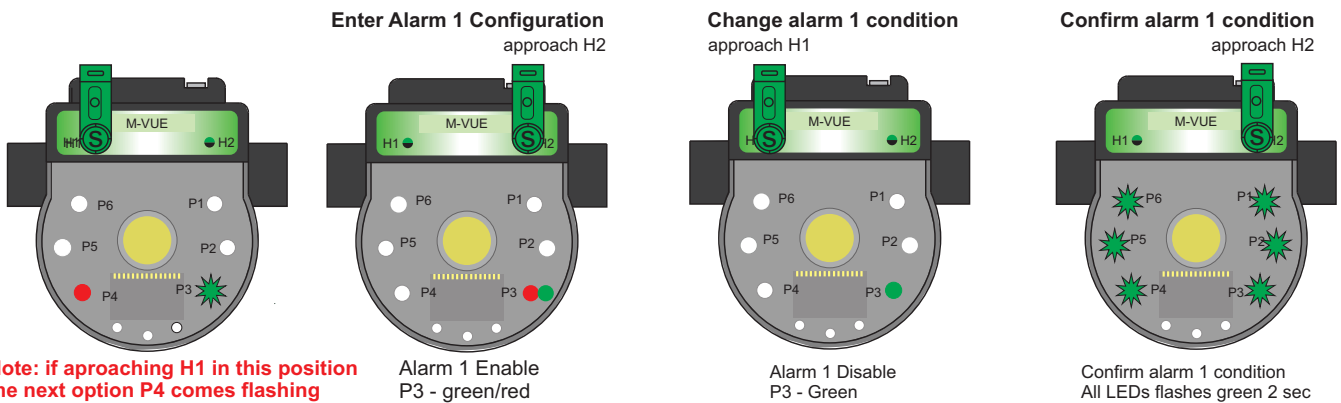

Using the M-VUE Menus

Output Inversion

The Main Menu is accessed via the magnetic buttons H1 and H2 and is used to calibrate and program the sensor.

- 1**

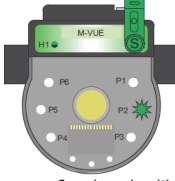

3 sec. to confirm hand calibration

Hold the magnetic key over H2 for 3 seconds. The ring of LED's will flash green for 2 seconds (this indicates Configuration Mode has been accessed)
- 2**



Approach

All LEDs will flash for 2 seconds immediately after P1 will flash green. Use H1 to select

 - P4: Output Inversion
- 3**

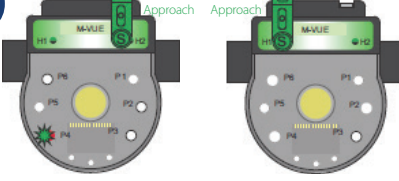

Confirm on H2 Change to Output Inversion

Approach Approach

Standard	Inverted
Output 1	Output 2
Output 2	Output 1

Standard Output Inverted Output

Once P4 has been selected hold the magnetic key over H2 to access the two available options and use H1 to select the desired option:

 - P4 LED lights red and green: standard mode
 - P3 LED light green: inverted mode

Note: The inverted mode effectively "swaps" the output bit definition.
- 4**

After H2 has been used to confirm the desired option the LEDs will flash green for 2 seconds indicating the new configuration has been accepted.
- 5**

To exit the configuration mode hold the magnetic key over H1 for more than 3 seconds or wait 30 seconds without approaching any magnetic key to either H1 or H2 buttons

LEDs Inversion

The Main Menu is accessed via the magnetic buttons H1 and H2 and is used to calibrate and program the sensor.

- 1**

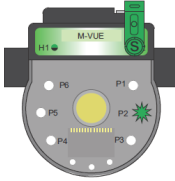

3 sec. to confirm hand calibration

Hold the magnetic key over H2 for 3 seconds. The ring of LED's will flash green for 2 seconds (this indicates Configuration Mode has been accessed)
- 2**



Approach

All LEDs will flash for 2 seconds immediately after P1 will flash green. Use H1 to select

 - P5: Output Inversion
- 3**

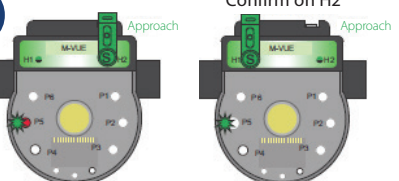

Confirm on H2

Approach Approach

Standard Output Inverted Output

Once P5 has been selected hold the magnetic key over H2 to access the two available options and use H1 to select the desired option:

 - P5 LED lights red and green: standard mode
 - P3 LED light green: inverted mode

Note: This options allows for LED indication of Open and Closed positions:

 - Standard Mode:
 - Open = Green ; Closed=Red
 - Inverted Mode:
 - Open = Red ; Closed = Green
- 4**

After H2 has been used to confirm the desired option the LEDs will flash green for 2 seconds indicating the new configuration has been accepted.
- 5**

To exit the configuration mode hold the magnetic key over H1 for more than 3 seconds or wait 30 seconds without approaching any magnetic key to either H1 or H2 buttons.

Using the M-VUE Menus

Restore Factory Settings

The Main Menu is accessed via the magnetic buttons H1 and H2 and is used to calibrate and program the sensor.

1

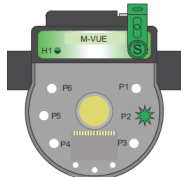

3 sec. to confirm hand calibration

Hold the magnetic key over H2 for 3 seconds. The ring of LED's will flash green for 2 seconds (this indicates Configuration Mode has been accessed)

2



3 sec. to confirm factory reset

All LEDs will flash for 2 seconds immediately after P1 will flash green. Use H1 to select

- P6: Factory Reset

3



Once P6 has been selected hold the magnetic key over H2 for 3 seconds. All LEDs will flash green for 2 seconds indicating the sensor has been reset to factory settings.

4

To exit the configuration mode hold the magnetic key over H1 for more than 3 seconds or wait 30 seconds without approaching any magnetic key to either H1 or H2 buttons

Setting Network Speed/Baud Rate (DeviceNet Units Only)

This parameter allows the data rate to be selected. The M-VUE can communicate data at a rate of 125, 250 or 500 Kbit/s (MVUE's default Baud Rate is 125 Kbits/s) **IMPORTANT!** The communication rate must be set to be the same one used in other network equipment.

1

Hold the magnetic key over H2 for 3 seconds. The ring of LED's will flash green for 2 seconds. (This indicates Configuration Mode has been accessed.)

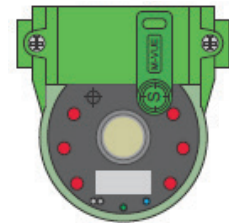

2

All LEDs will flash for 2 seconds immediately after P1 will flash green. Use H1 to select SET on the LCD screen

- P2 and P5 LEDs will flash green



3

Once P3 has been selected hold the magnetic key over H2 to access the two available options and use H1 to select the desired option:

- P3 LED lights red and green: integrated solenoid option.
- P3 LED light green: external or remote solenoid option

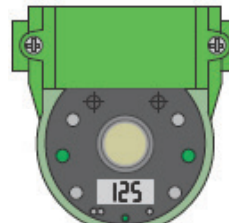

4

Use H1 to select the desired rate. (125, 250 or 500)
Use H2 to confirm the desired numeric value.

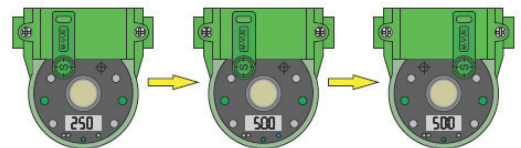

5

After the "units" digit has been set, the "TENS" digit will flash (waiting to change or confirm the current value)

6

To exit the configuration mode hold the magnetic key over H1 for more than 3 seconds.

Note: Baud Rate configuration of MVUE can also be performed remotely during valve commission form the control system (DCS or PLC)

Technical Data

Technical Details

Valve Size Range	0.25"–2.00" (DN8–DN50)
Temperature Range	0°C to + 70°C
Sensing Technology	Continuous sensing via Hall Effect sensors 20% Tolerance
Target	Composite ferrous magnet
Stroke/Travel	3 mm (Minimum) 22 mm (Maximum)
Position Indication	Green LEDs - Open Red LEDs - Closed Physical position indicator
Feedback Options	24VDC P2P AS-i version 2.0 standard address AS-i version 2.1 extended address AS-i version 3.0 extended address DeviceNet
Programming	Local Programming: via magnetic key Remote Programming: At control panel (Networking versions only)
Standard Connection	P2P with SOV: M12 5 pin P2P without SOV: M12 5pin AS-i: M12 4 Pin DeviceNet: Mini 7/8" 5 pin

Materials of Construction

Sensor Mounting Base	Glass Reinforced Polybutylene Terephthalate (PBT)
Sensor Electronics Module	Polycarbonate (PC)
Cap	Polycarbonate (PC)
Seals	Buna N (Nitrile)
Connector	Stainless steel
Fasteners	Stainless steel
Target	Composite ferrous magnet

Power Consumption

Type	PNP 24Vdc	ASi 31.5 Vdc	DeviceNet 24 Vdc
M-VUE (solenoid OFF)	< 35 mA	< 35 mA	< 40 mA
M-VUE (solenoid ON)	< 63 mA	< 70 mA	< 75 mA

Solenoid / Pneumatic Details

Optional Integral Solenoid

- Solenoid case: PBT
- Configuration: 3-Way, 2-Position, Spring Return
- Type: Direct Acting
- Voltage: 24 Vdc
- Wattage: 0.9 W
- Cv: 0.5
- Air connection: 1/8" BSP or 1/8" NPT Stainless Steele reinforced
- Optional: solenoid exhaust block

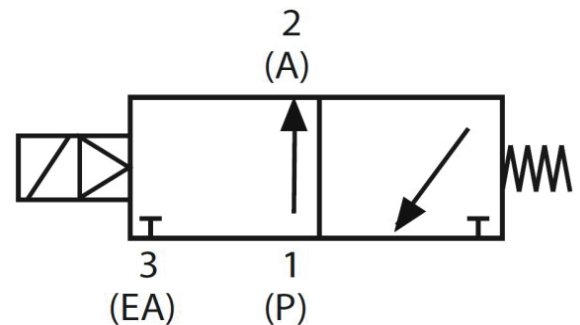

Troubleshooting Alarms

M-VUE can display three alarms:

- Alarm 1: Unexpected position change
- Alarm 2: Stroke out of range
- Alarm 3: Stop at the middle of the way

Alarm 1: This alarm indicates that an unexpected position change has occurred. P1 flashes red to indicate Alarm 1. The alarm will correct itself after the fault has been cleared

- Check if the aseptic valve operates correctly
- Check air connectors and required pressure

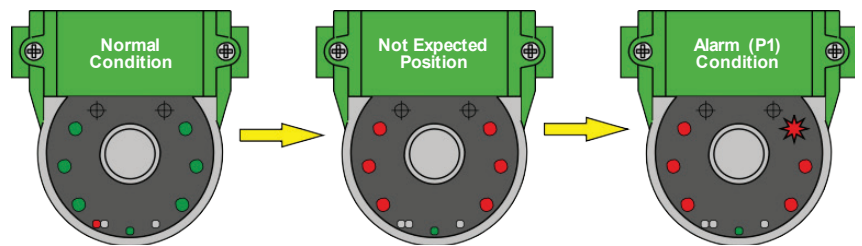

Alarm 2: Indicates that the actuator shaft has traveled over or under the values stored during initial calibration. P2 will flash red to indicate the alarm ($\pm 20\%$ tolerance)

- Check for actuator damage
- Perform Self-Calibration again

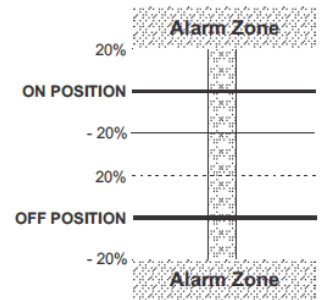
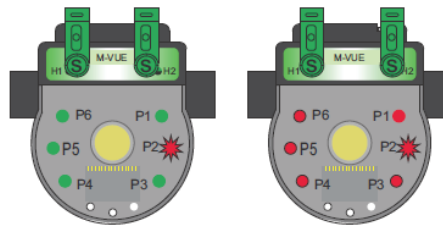

Alarm 3: Indicates that the actuator shaft has not reached the desired position after the initial position has been detected. P3 will flash red to indicate the feedback sensor status Position 1 (Open) and Position 2 (Closed) are 0.

- Check for actuator damage
- Verify correct pressure supplied to the actuator

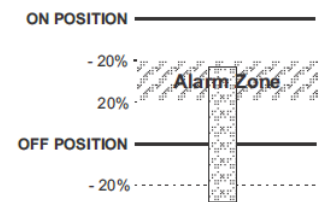
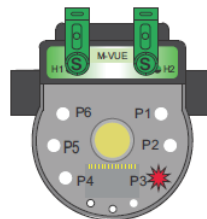

Note: To disable any LED alarm hold two magnetic keys over H1 and H2 for 6 seconds. The corresponding LED alarm will stop flashing. The generated alarm remains in the register and can be viewed over a bus network or by holding two magnetic keys over H1 and H2 for 6 seconds

Dimensions

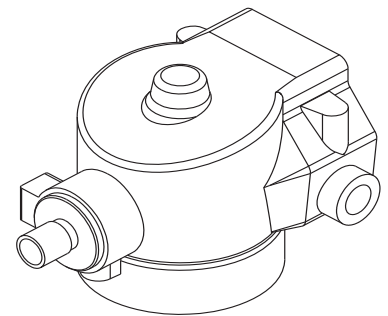
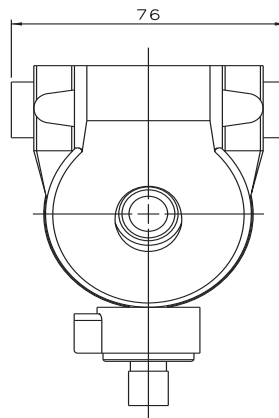
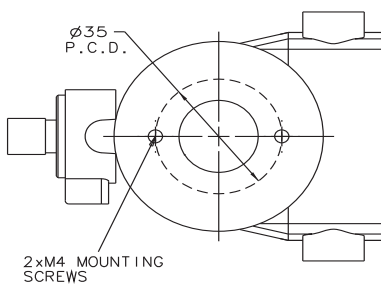
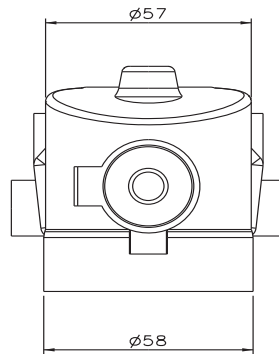
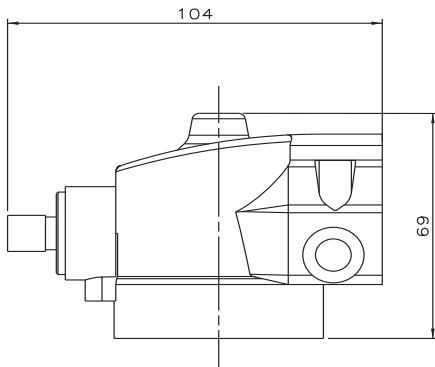

ISOMETRIC VIEW
FOR CLARITY

*Uncontrolled in hard copy format



Crane ChemPharma & Energy
Crane Process Flow Technologies Ltd.
Grange Road
Cwmbran, Gwent NP44 3XX
UK
Tel.: +44 163 348 6666
Fax: +44 163 348 6777
SaundersOrders@CraneCPE.com
SaundersQuotes@CraneCPE.com
www.cranecpe.com



Crane Process Flow
Technologies SPRL / BV
Avenue Franklin No. 1
Wavre, B-1300, Belgium
Tel: +32 10 8184 44
Fax: +32 10 8184 58

Crane Process Flow
Technologies (India) Ltd
Solitaire, 5th & 6th Floor, S.No. 131 / 1+2,
ITI Road, Aundh, Pune - 411007, India
Tel: +91 20 3056 7800
Fax: +91 20 3056 7812

Crane ChemPharma & Energy
4526 Research Forest Dr,
Suite 400
The Woodlands, TX 77381
USA
Tel: (936)-588-8360

brands you trust.



COMPAC-NOZ[®]



DEPA[®]

ELRO[®]

DUO-CHEK[®]



NOZ-CHEK[®]



RESISTOFLEX[®]



UNI-CHEK[®]



XOMOX[®]

Crane Co., and its subsidiaries cannot accept responsibility for possible errors in catalogues, brochures, other printed materials, and website information. Crane Co. reserves the right to alter its products without notice, including products already on order provided that such alteration can be made without changes being necessary in specifications already agreed. All trademarks in this material are property of the Crane Co. or its subsidiaries. The Crane and Crane brands logotype, in alphabetical order, (ALOYCO[®], CENTER LINE[®], COMPAC-NOZ[®], CRANE[®], DEPA[®], DUO-CHEK[®], ELRO[®], FLOWSEAL[®], JENKINS[®], KROMBACH[®], NOZ-CHEK[®], PACIFIC VALVES[®], RESISTOFLEX[®], REVO[®], SAUNDERS[®], STOCKHAM[®], TRIANGLE[®], UNI-CHEK[®], WTA[®], and XOMOX[®]) are registered trademarks of Crane Co. All rights reserved.