

**brands you trust.**

Installation/ Assembly Instructions  
**Saunders<sup>®</sup> I-VUE Point-to-Point (P2P)**  
**Intelligent Sensing Technology**



Crane ChemPharma & Energy

[www.saundersvalves.com](http://www.saundersvalves.com)  
[www.cranecpe.com](http://www.cranecpe.com)

# Maintenance Instructions Table of Contents

<b>1 - Operating Instructions</b>	<b>3</b>
1.1 - Basic Safety Instruction	3
1.1.1 - High Pressure	3
1.1.2 - Electric Risks	3
1.1.3 - Hazardous Situation	3
<b>2 - Scope of Supply</b>	
2.1 - Included with Sensor Pack	3
2.2 - Optional Accessories	3
<b>3 - Overview</b>	<b>4</b>
<b>4 - Description</b>	<b>5</b>
4.1 - Innovative Valve Monitoring	5
4.2 - Highly Visible LEDs	5
4.3 - Visual Position Indicator	5
4.4 - Self-Calibration	5
4.5 - Digital Display	5
4.6 - Cycle Count Alarm	5
4.7 - Cycle Time	5
4.8 - Set Point Tolerance	5
4.9 - Password	5
4.10 - Sleep Mode "Save Energy"	6
4.11 - Smart Window Digital Display	6
4.12 - Local Alarm Indication	6
4.13 - Sensor Clock	6
4.14 - Valve Actuator Cycle Counter	6
4.15 - Partial Counter	6
4.16 - Life Time Counter "Total Counter"	6
4.17 - Counter Notation	7
4.18 - Factory Settings	7
<b>5 - Mechanical Drawings</b>	<b>7</b>
<b>6 - Operation</b>	<b>8</b>
6.1 - Sensing Technology	8
6.2 - Touch-Less Magnetic Buttons	8
6.3 - Magnetic Keychain	8
6.4 - Self-Calibration Setting	8
6.5 - Calibration without Integral Solenoid Valve	8
6.6 - Solenoid Valve Override (with Integral Solenoid Only)	8
<b>7 - Compressed Air</b>	<b>9</b>
7.1 - Indispensable Components of a Pneumatic System	9
7.2 - Compressed Air Distribution	9
7.3 - Sizing of Pipes	9
<b>8 - I-VUE Pneumatic Data</b>	<b>9</b>
8.1 - Identifying the Connections	9
8.2 - Pneumatic Data	9
<b>9 - Mounting Process</b>	<b>10</b>
<b>10 - Solenoid Valve Replacement Procedure</b>	<b>11</b>
<b>11 - 24 Vdc P2P Version</b>	<b>12</b>
11.1 - Electrical Connection	12
11.2 - Connection with the Control System	12
11.3 - Output Short Circuit Detection	12
11.4 - AS-Interface Versions	12
<b>12 - Understanding the Main Menu</b>	<b>13</b>
12.1 - How to Access and Exit the Menu	13
12.2 - Accessing the Menu	13
12.3 - Exiting the Menu	13
12.4 - Going through the Menu Settings	13
12.5 - Fast Key Access	14
<b>13 - Describing the Menu Options</b>	<b>15</b>
<b>14 - I-VUE Alarm Codes</b>	<b>18</b>
<b>15 - Default Factory Settings</b>	<b>19</b>

# Maintenance Instructions Safety and Scope of Supply

## 1 - Operating Instructions

### 1.1 - Basic Safety Instructions

These safety instructions do not make allowance for:

- Contingencies and events which may arise during the installation, operation, and maintenance of the sensor.
- Local safety regulations; the operator is responsible for observing these regulations, also with reference to the installation personnel.



#### 1.1.1 - High Pressure

- Before dismantling pneumatic lines and valves, turn off the pressure and vent the lines.
- To prevent damage, make sure that all the pneumatics connections are made correctly.

#### 1.1.2 - Electrical Risks

- Before working on the sensor, switch off the power supply and prevent reactivation.
- Observe applicable accident prevention and safety regulations for electrical equipment.

#### 1.1.3 - Hazardous Situation

To avoid injury, ensure:

- That the system cannot be activated unintentionally.
- Installation and maintenance may be carried out by authorized technicians only.
- After an interruption in the power or pneumatic supply, ensure that the process will be restarted in a defined and controlled manner.
- The sensor must be operated according to the operating instructions.

## 2 - Scope of Supply

Check the package immediately upon receipt of delivery; assure that the contents are not damaged and packing list match contents. If there are any discrepancies, please contact the factory.

### 2.1 Included with Sensor Pack



### 2.2 Optional Accessories

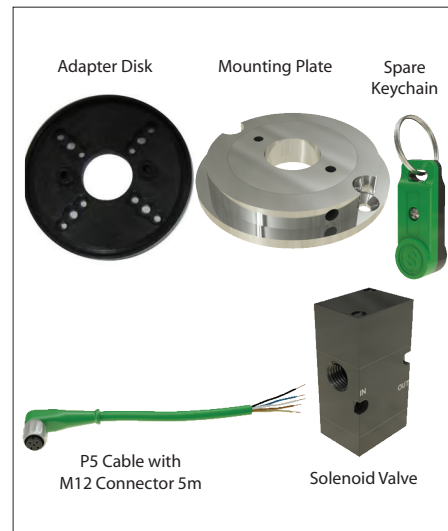

#### WARNING

- DO NOT CONNECT OR DISCONNECT WHILE CIRCUIT IS LIVE UNLESS LOCATION IS KNOWN TO BE NONHAZARDOUS.
- SUBSTITUTION OF COMPONENTS MAY IMPAIR SUITABILITY FOR CLASS I, DIVISION 2.
- THE EQUIPMENT SHALL BE INSTALLED IN LOCATIONS WITH LOW RISK OF MECHANICAL DANGER.
- TO PREVENT THE RISK OF ELECTROSTATIC SPARKING, THE ENCLOSURE SHALL ONLY BE CLEANED WITH A DAMP CLOTH.

#### SPECIAL CONDITION OF USE

- The M12 Lock must be used with electrical connection options V1, V15 and V16.
- The 7/8" Lock must be used with electrical connection option VM



Label with the ATEX marking  
Canadian Cert Number: FM16CA0200X

# Maintenance Instructions Overview

## 3 - Overview

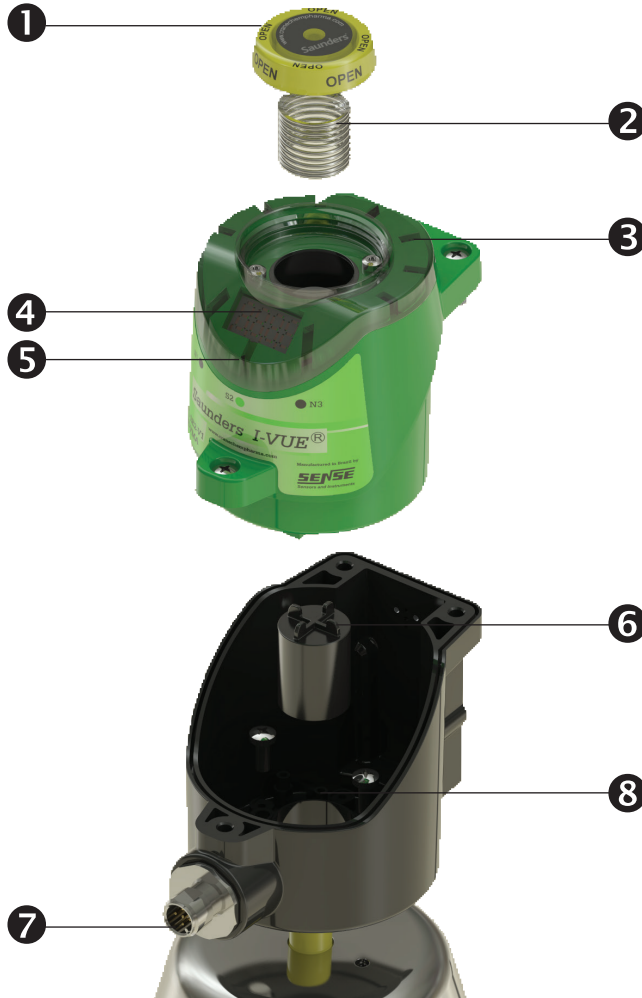

*Please register your Saunders® I-VUE at: [www.saundersI-VUE.com](http://www.saundersI-VUE.com) to access important installation information, download Electronic Data Sheets (EDS), and receive notifications of required firmware upgrades.*

### 1 - Visual Local Indicator

Bright yellow physical indicator shows through the transparent cap.

### 2 - Spring

A spring driven by indicator pushes cap upward.

### 3 - Extra Bright LEDs

Green LEDs indicate open position and red LEDs indicate closed position.

### 4 - Smart Window

The Smart Window provides visual information to assist in calibration and programming of the sensor. The Smart Window also displays information for the user.

### 5 - Touch-Less Magnetic Buttons

The sensor is equipped with three magnetic buttons that allow configuration of all functions.

### 6 - Sensor Target

A ferrite target housed in resin sensitizes the magnetic coils of the I-VUE sensor.

### 7 - M12 Connector

Electric connection via stainless M12/4 pin connector when used with remotely located solenoid; a stainless M12/5 pin connector is used with integral solenoid option.

### 8 - Adapter Disk

The adapter disk is used to mount the sensor on top of actuators that have mounting holes centers different to 35mm, or to allow 360° rotation of the sensor.

# Maintenance Instructions Description

## 4 - Description

### 4.1 - Innovative Valve Monitoring

The I-VUE is an intelligent valve sensor which integrates accurate and reliable non-contacting sensing technology with advanced electronics. The I-VUE is calibrated and programmed through hands-free magnetic buttons. Additional standard features include bright LEDs, Smart Window display, visual position indicator and optional low power solenoid. I-VUE brings a new level of position sensing technology to diaphragm valves used in life science applications.

### 4.2 - Highly Visible LEDs

A ring of bright red and green LEDs indicate open and closed positions

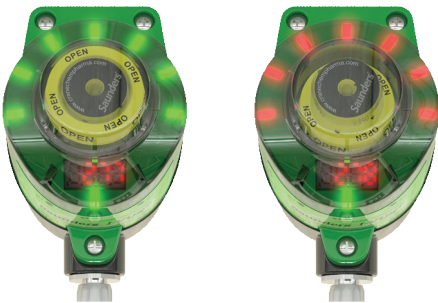

### 4.3 - Visual Position Indicator

Bright yellow indicator is enclosed in transparent cover and is operated by a spring; single indicator displays position on all size valves.

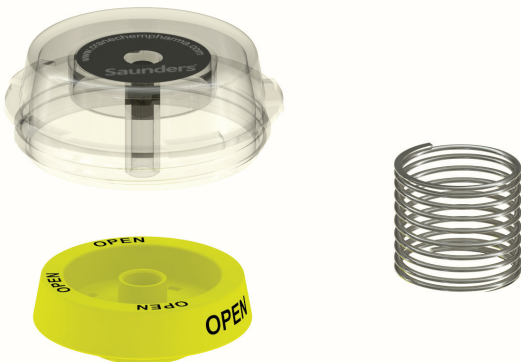

### 4.4 - Self-Calibration

All the smart sensor needs is 24V DC and the magnetic keychain. This device will automatically cycle the valve three times, measuring travel and setting open and closed positions. I-VUE eliminates the need to remove covers and set limit switches or to program other alarms and functions.

### 4.5 - Digital Display

I-VUE has a unique Smart Window which uses LEDs to display valve position, alarm codes, and to assist in calibrating and programming the device.



### 4.6 - Cycle Count Alarm

The I-VUE can be programmed to show an alarm when a preset number of cycles have been reached or a preset number of days has elapsed. This can help with preventive maintenance.

### 4.7 - Cycle Time

I-VUE automatically records cycle time during the initial calibration. The optional cycle time alarm can be programmed to show an alarm when actual cycle time varies by 30% to 50% from the stored cycle time. A local alarm will be generated on the local display or sent to the PLC in the network version indicating variance in operating time.

### 4.8 - Set Point Tolerance

The advanced Set Point Tolerance is pre-configured at 20% from the established set point in the open and closed positions. Set Point Tolerance can be programmed at 10% to 30% in the open position and from 10% to 50% in the closed position to suit specific system requirements.

### 4.9 - Password

The sensor can be password protected to restrict access to the custom programming. Setting, changing, or disabling of passwords is done in the configuration menu.

### 4.10 - Sleep Mode "Save Energy"

Although display and signaling LEDs have low power requirements, the configuration menu allows them to power down if there is no operation of the valve or magnetic buttons to save energy.

After the selected time (from 5 to 15 minutes), the LEDs and display goes off.

The return of signaling occurs if the sensor generates any alarm or if any of the magnetic buttons were activated.



**NOTE:** In case of alarm, the LED over "N3" magnetic button keeps blinking in green / red.

# Maintenance Instructions Description

## 4.11 - Smart Window Digital Display

The Smart Window displays: Valve Position, Partial Cycle Counter, Total Counter, and Days Worked as shown below.

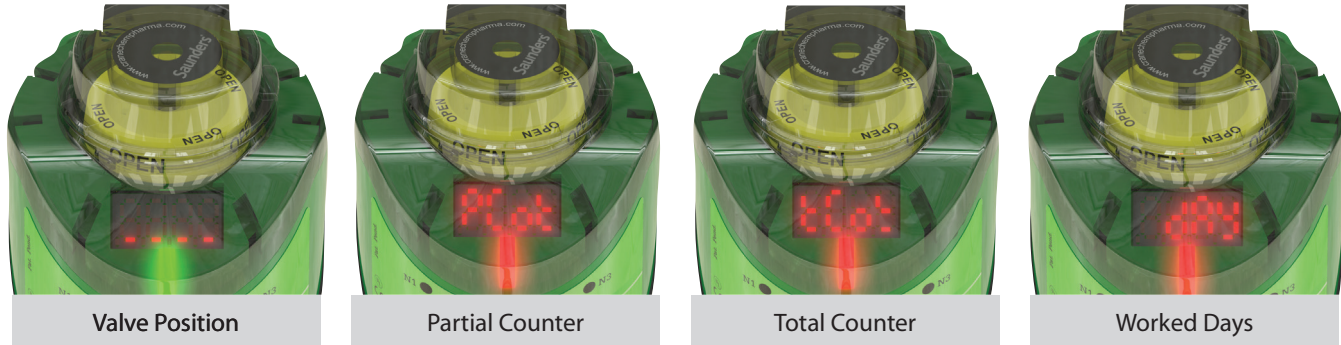

## 4.12 - Local Alarm Indication

The Smart Window displays an alarm code for 5 seconds and the LEDs over the "N3" magnetic button blinks continuously in green / red indicating that an alarm has been triggered. The user can see the alarm code at any time by placing the North Polarity of the keychain (side marked "N") over the "N3" magnetic button - the alarm code will be displayed for 5 seconds.

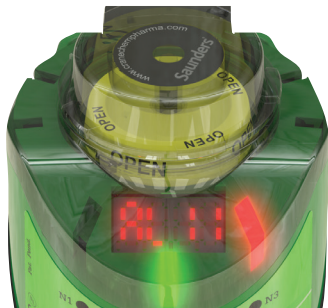

### IMPORTANT!

In cases where the sensor generates the alarms 4, 5, 6, 8, or 9 the two outputs go to logic level "1" to be interpreted as an alarm to the remote control PLC.

Codes	P2P Version	Security
AL 1	Alarm of partial cycle counter	-
AL 2	Alarm of worked days	-
AL 3	Alarm of date	-
AL 4	Alarm of time to open or close	P2P outputs in "1"
AL 5	Solenoid command	P2P outputs in "1"
AL 6	Stroke out of range	P2P outputs in "1"
AL 7	Not expected position change	-
AL 8	Short circuit on solenoid coil	P2P outputs in "1"
AL 9	Damaged coil	P2P outputs in "1"
AL 10	Alarm of internal temperature	-

## 4.13 - Sensor Clock

The sensor has a day/time clock that must be set for alarms "Day Alarm" and "Alarm Date" to work properly. The user sets the hour, day, month, and year. Instructions to set the clock can be found in the flowchart overview on pages 18 and 19.

## 4.14 - Valve Actuator Cycle Counter

The display can show the numbers of cycles performed by the valve and actuator. The sensor has two counters - the Partial Counter and the Life Time Counter.

## 4.15 - Partial Counter

This feature can be used as notification of the number of cycles since the last diaphragm change out or other maintenance or service event. The counter can be reset and a new number of cycles can be programmed to aid further preventive maintenance.

## 4.16 - Life Time Counter "Total Counter"

This is a grand total counter; i.e. this count is not reset when the partial counter is cleared, even if you reset several times.

The grand total indicates the total number of cycles independent of all partial cycle counts, even after several resets of the partial counter, and seeks to identify the lifetime of the system (valve / actuator).

Its maximum capacity is  $99 \cdot 10^6$  cycles, and can be reset only by entering the main menu in order to monitor a new valve, or for a relocation of the sensor to another valve.

# Maintenance Instructions Description and Drawings

## 4.17 - Counter Notation

The display uses engineering notation (BASE 10) to indicate the number of cycles, i.e.:

**XY\*10 Z XY\*EZ**

Indication Notation for Cycle Numbers			
<b>10E3</b>	10 * 10 <sup>3</sup>	10 x 1000	10.000 cycles
<b>21E2</b>	21 * 10 <sup>2</sup>	21 x 100	2.100 cycles
<b>51E4</b>	51 * 10 <sup>4</sup>	51 x 10000	510.000 cycles

## 4.18 - Factory Settings

The sensor comes with the following factory settings:

Factory Settings	
Tolerance	{ H - ( 20 ) } { L - ( 20 ) }
Travel Time Alarm	OFF
Partial Counter (Alarm)	OFF
Worked Days (Alarm)	OFF
Date Alarm	OFF
Display Function	P_Cot (Partial Counter)
Output NO / NC	NO
Sleep Mode	OFF
Auto Setting Mode	3
Hand Setting Mode	Enters and performs the function
Sol Alarm	OFF
Set Alarm P2P Outputs	OFF
Password Setting	Enters and performs the function
Set Clock	Enters and performs the function
Total Counter	Enters and performs the function
Factory Setting Restore	Enters and performs the function

## 5 - Mechanical Drawings

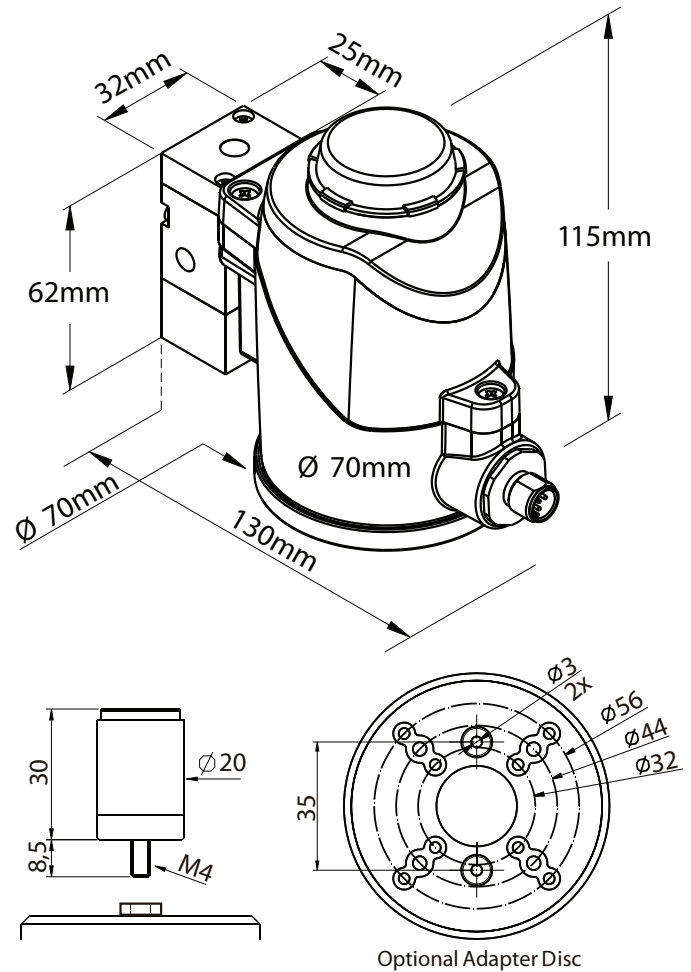

**Order Separately**

Please register your Saunders® I-VUE at:

[www.saundersI-VUE.com](http://www.saundersI-VUE.com)

to access important installation information, download Electronic Data Sheets (EDS), and receive notifications of required firmware upgrades.

# Maintenance Instructions Operation

## 6 - Operation

### 6.1 - Sensing Technology

The friction-free operating principle employed by I-VUE is based on a non-contacting detection of the actuator valve movement. An electronic circuit converts the variation of the electromagnetic field into a signal that is proportional to the displacement of the sensor's target. With its sophisticated electronics, the I-VUE detects movements of 0.2 mm or less with high resolution of 16 bits.

### 6.2 - Touch-Less Magnetic Buttons

The sensor is equipped with 3 magnetic buttons for use in calibrating and programming the device. The buttons allow the user to configure all functions of the sensor without opening the enclosure and potentially risking fluid ingress.

### 6.3 - Magnetic Keychain

To activate the magnetic buttons, bring the magnetic keychain adjacent to one of the buttons, matching polarity (north (N) or south (S)) on the keychain with the polarity of the button (north (N) or south (S)). The LED above the magnetic button will glow red when the keychain activates the button. To push the buttons, just hold the keychain with the correct polarity near the magnetic buttons and see that the red LED light indicates the detection.

### 6.4 - Self-Calibration Setting

The I-VUE sensor has a unique self-calibration system, activated by holding the magnetic key chain with North pole "N" near "N3" magnetic button for more than 3 seconds. The sensor will ask the user to confirm they wish to Self Calibrate by displaying "SUre" on the smart window display. To confirm Self Calibration is required hold the South pole "S" near "S2" magnetic button, to decline Self Calibration hold the North pole "N" near "N3" magnetic button (this will take the I-VUE sensor back to its previous state). If Self Calibration is confirmed the I-VUE sensor will run the self-calibration process, regardless of type of connection to the control system (PLC or Industrial Network), making the setup process very fast and efficient.

The sensor will activate the solenoid which controls the actuator in 3 consecutive cycles to learn the open and closed positions according to actuator travel. To avoid an undesired recalibration, the user must confirm with S2 bottom, when smart window shows "SUre". I-VUE can be programmed to perform 5 or 10 cycles for calibration instead of the default 3 cycles, if desired.

### 6.5 - Calibration without Integral Solenoid Valve

When a remote solenoid valve is used, the N black side of the magnetic key is placed against the N3 button; this brings the operator directly into the calibration menu, the Smart Window display will read "SUre" and the operator confirms this using the green S side of the key against the S2 button. If the valve is not in the closed position, the remote solenoid must then be directed to close the valve, the Smart Window will read "LL", use the green side of magnetic key against the S2 button to confirm and the closed set point will be defined; complete the process by opening the valve via the remote solenoid and confirm setting with the S2 key. When the window displays "HL"; the open set point has been defined.

### 6.6 - Solenoid Valve Override (With Integral Solenoid Only)

If the sensor is assembled with an optional solenoid valve, it can be forced open by holding the magnetic keychain for 3 seconds, with "N" pole near "N1". To de-energize, repeat the same process. It is also possible to force the solenoid by the manual override actuator on the solenoid valve body.

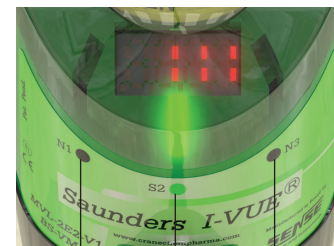

North Pole Sensitive    South Pole Sensitive    North Pole Sensitive

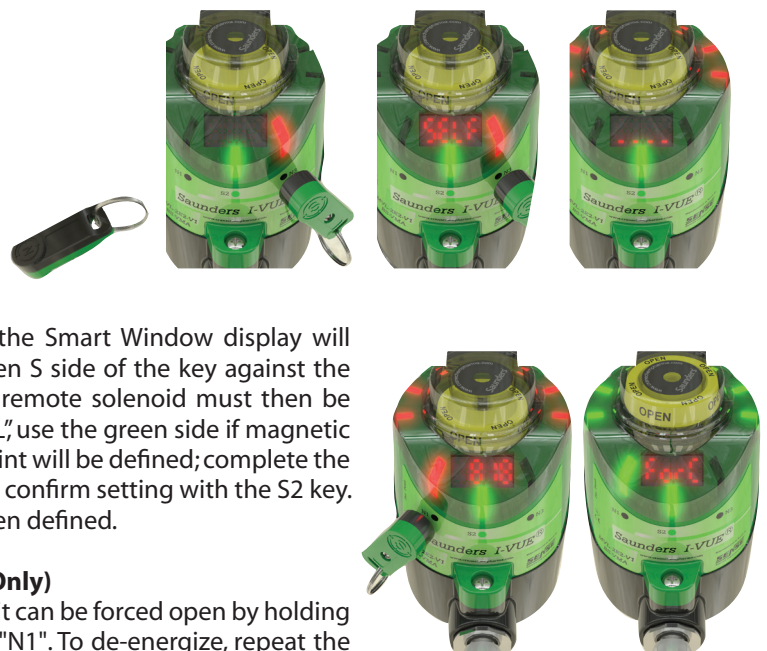



# Maintenance Instructions Compressed Air and Pneumatic Data

## 7 - Compressed Air

Compressed air is a source of energy widely used in applications in industrial environments. It results from compression of ambient air.

The compressor is used for generating pressured air. To correctly size the compressor is necessary to know the amount of pressure and volume of air required per unit of time. Compressed air has advantages compared with other energy sources, because:

- The air is abundant and available everywhere,
- It can be transported for long distances,
- It can be stored in reservoirs,
- It is suitable for explosive atmospheres, because there is no risk of combustion.

### 7.1 - Indispensable Components of a Pneumatic System

The basic equipment needed for a reliable air supply include:

- Compressor
- Cooler
- Pre-Filter
- Dryer
- Post-Filter
- Air Tank

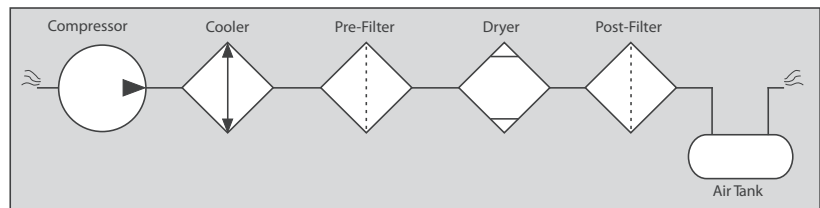

### 7.2 - Compressed Air Distribution

A correct sizing of the compressed air distribution system ensures low pressure drop between the generation and consumption of the air. The distribution piping for compressed air can be galvanized steel, stainless steel, aluminum, copper, engineering plastic, or nylon. To determine the best route for the pipeline, it is necessary to know where the main consumption points and isolated points are located.

### 7.3 - Sizing of Pipes

The sizes of pipes should be designed to allow an acceptable pressure drop, no more than 10% of the applied pressure. In sizing of pipes, one must consider any likely future demand because the system will become inefficient if demand exceeds the air supply.

## 8 - I-VUE Pneumatic Data

The I-VUE can be supplied with a 3/2 way solenoid valve with 1/8" NPT pneumatic connections. The valve has a manual override button and can also be activated via N1 magnetic button of the sensor in operation mode.

### 8.1 - Identifying the Connections

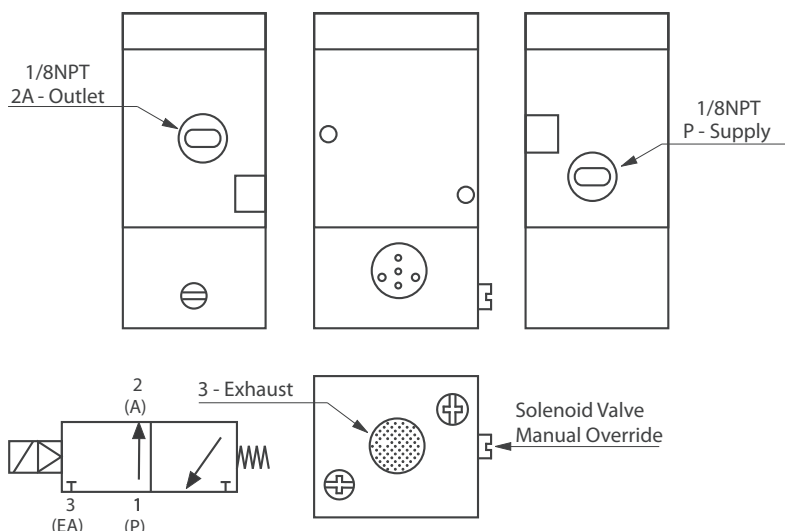

### 8.2 - Pneumatic Data

Solenoid Coil	
Power	24Vdc ± 10%
Capacity	20mA / 0.6W
Encapsulation	epoxy resin
Valve Body	
Type	piloted
Principle	spool
Pneumatic connections	1/8" NPT
Exhaust	40µm sintered bronze insert
Number of ports / positions	3/2
Manual operator	yes
Pressure range	1.5 to 7 bar
Cv	0.9

# Maintenance Instructions Mounting Process

## 9 - Mounting Process

Follow the steps below for mounting the sensor on the valve.

1 - The sensor fits directly to Saunders<sup>®</sup> S360 actuator. Adapters are required for the Saunders<sup>®</sup> EC and ECX actuators.

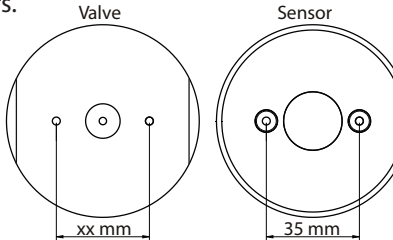

**NOTE:** The adapter disk is provided as an accessory and must be ordered separately.

2 - Install the sensor base at the top of the actuator (if necessary, install the adapter disk) and insert the fixing screws.

### Direct Mounting on the Valve



**NOTE:** It is necessary to change the I-VUE base screws, use the short one supplied with the mounting adapter.

3 - Thread the target sensor into the indicator until it bottoms out.



4 - Fit the sensor module on the sensor base.



5 - Insert the spring and the visual local indicator screwing it on the top of the sensor module.



6 - Tighten the three screws that hold the sensor module on the sensor base.



7 - Place the 1/8" NPT quick coupling connectors on the pneumatic holes of the valve and the pneumatic actuator.



# Maintenance Instructions Solenoid Valve Replacement

8 - Before making pneumatic connections, check the location of each air port in the drawing on page 9 (identifying the connections).

9 - Make the pneumatic connection with 6.0mm tubing and electrical connection with a M12 4 (without) or 5-pins (with solenoid) female connector.



10 - The sensor is ready to be configured. See the configuration flowchart on pages 18 and 19.

## 10 - Solenoid Valve Replacement Procedure

If you need to replace the solenoid valve, follow the steps below:

1 - De-energize the sensor, removing the connector.



2 - Remove the pipes and pneumatic quick coupling connectors of the valve body.



3 - Loosen the three screws that hold the sensor module on the sensor base.



4 - Pull out the sensor module, by hand, to access the solenoid coil.

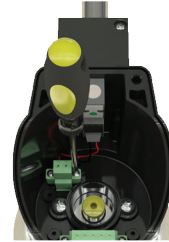

5 - Remove the target sensor and disconnect the wires from the coil of electrical terminals.

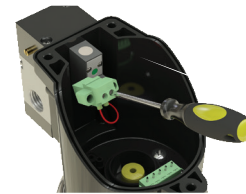

6 - Remove the fixing screws of the coil and the valve body.



**NOTE:** The coil and the valve body have sealing O-rings; take care not to lose them.

7 - Insert the new coil with the sealing ring in the sensor connection box and insert the fixing screws.

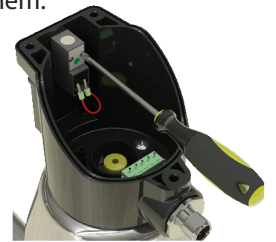

8 - Connect the wires from the solenoid in the electrical terminals inside the connection box.



9 - Replace the valve body with the sealing O-rings and secure with the screws, then replace the target sensor.

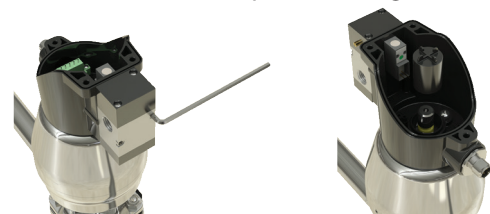

10 - Repeat the steps from 6 to 9 of the previous procedure.

# Maintenance Instructions Point-to-Point Connection

## 11 - 24Vdc P2P Version

The P2P electronic output sensor is used on discrete installations and to replace basic mechanical switches.

Output 1 indicates when the valve is open, and sends this signal to the PLC input card, I-VUE LEDs glow green for this condition.

Output 2 indicates that the valve is closed, and sends this signal to the PLC input card, I-VUE LEDs glow red for this condition.

When the valve is moving from open to close or vice versa the two outputs are de-energize. NO or NC operation can be changed through the main configuration menu.

### 11.1 - Electrical Connection

The sensor uses a standard M12 connector with 5 pins, 2 pins for DC power supply, another 2 pins for P2P outputs and pin number 5 to receive the command to drive the solenoid valve.



**NOTE:** The sensor can be sent without solenoid valve, and for this condition the connector will have just 4 pins: 2 for DC power supply and other 2 for the P2P outputs.

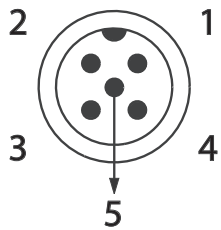

**Sensor Connector - Male**

Pin	Wire Color	Designation
1	brown	24Vdc (+)
2	black	P2P 1
3	blue	24Vdc (-)
4	white	P2P 2
5	yellow	solenoid

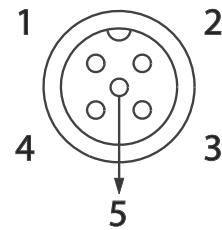

**External Connector - Female**



### 11.2 - Connection with the Control System

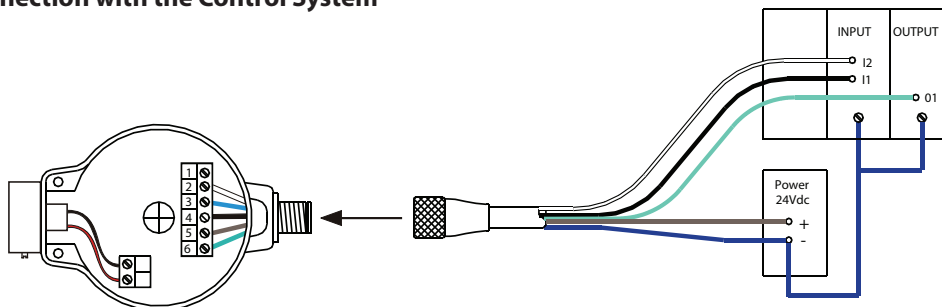

### 11.3 - Outputs Short Circuit Detection

To increase the reliability of the system incorporating I-VUE sensors, the P2P version is equipped with a circuit capable of detecting short circuit in the P2P sensor outputs, indicating problems with electrical wiring, connections or input cards of the controller. An alarm is generated by the sensor and indicated on the Smart Window display (above "N3" magnetic button) and the display will show the alarm code for 5 seconds (AL 11).

# Maintenance Instructions Understanding the Main Menu

## 12 - Understanding the Main Menu

The Main Menu is accessed via the magnetic buttons and is used to calibrate and program the sensor.

### 12.1 - How to Access and Exit the Menu

When the sensor is turned on, it performs a self-check (the Smart Window display shows horizontal dash characters and all the LEDs flash). After self-check the LEDs indicate the valve position and the display will show the partial count number if the factory settings for the sensor are unchanged.

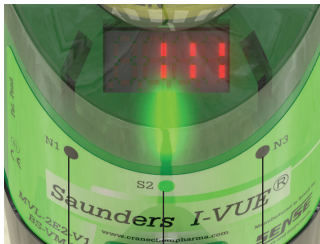

North Pole Sensitive    South Pole Sensitive    North Pole Sensitive

The sensor is equipped with three magnetic buttons N1, S2, and N3 that provide access to the menu. These buttons are activated by a magnetic keychain supplied with the sensor.

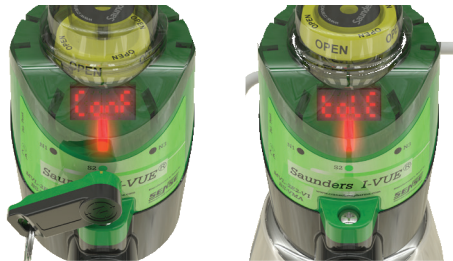
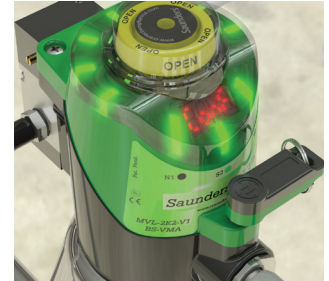

### 12.2 - Accessing the Menu

To access the menu, just hold the magnetic keychain with the south pole marked "S" over the S2 magnetic button for three seconds. The display will show "ConF" and then it will show "ToLE" for tolerance.

To scroll through the main menu functions, use the following keys:

- N3 to go down to next function
- N1 to go up to the previous function
- S2 to confirm the function

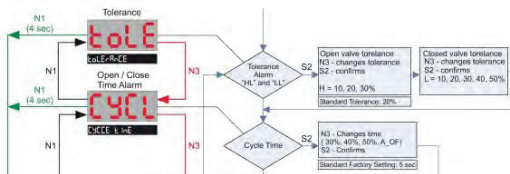

**NOTE:** When the last function ("FACToRY SEt") is reached, use N3 key to return to the first function ("ToLErAnCE").

### 12.3 - Exiting the Menu

To exit the menu, hold the magnetic keychain with the north pole "N" over magnetic N1 for 4 seconds until its red LED lights up. The Smart Window display shows "END"; it will then show the valve cycle numbers indicating that the sensor is in operation mode.

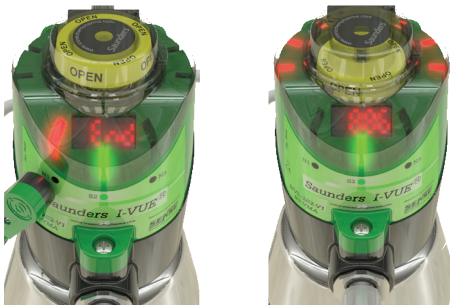

### 12.4 - Going through the Menu Settings

In configuration mode, choose the function that you want to change (use the N3 magnetic button to go down and N1 button to go up); to access or confirm the functions use S2 button.

The button functions may vary depending on the chosen option (see the configuration flowchart on pages 18 and 19). After finishing the settings, confirm with the S2 button and then N1 button for 4 seconds to exit configuration mode.



**NOTE:**

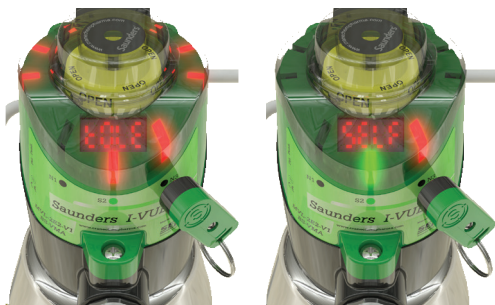

Return to a function by approaching and removing the magnetic keychain with the north pole "N" over the N1 magnetic button quickly. If the user holds the magnetic keychain over N1 magnetic button for more than 4 seconds, the sensor will exit the configuration mode.



# Maintenance Instructions Understanding the Main Menu

## 12.5 - Fast Keys Access

There are three functions for fast access: **Forced Solenoid, Self-Calibration Setting, and Demo Mode:**

Fast Key Access				
Button	Time	Mode	Function	Display Message
N1	3s	Run	Force Solenoid (to energize the solenoid coil)	Sol ForCED
N3	3s	Run	Self-Calibration Setting (run auto setup)	
N1 and N3	3s	Run	Demo Mode (open and close for 3 seconds)	deNo tEST
		Conf	Reset Password (when the display asks for password)	



### Force Solenoid:

With the sensor in operation, hold the magnetic keychain with the north pole "N" over the N1 button for 3 seconds. The display shows "Sol ForCED" and the LED will light in green. To de-energize the solenoid, hold again the magnetic keychain over N1 magnetic button for 3 seconds.



### Self-Calibration Setting:

The I-VUE sensor has a unique self-calibration system which is activated by holding the magnetic key chain with North pole "N" near "N3" magnetic button for 3 seconds. If self calibration is chosen (S2 to confirm, N3 to go back) The sensor will run the self calibration process. The number of cycles used to calibrate the open and closed set points can be changed to 5 or 10 cycles (see Flow Chart pages 18-19). After self-calibration, the sensor will return to the operating mode.



### Demo Mode:

For this configuration it is necessary to have two magnetic keychains. Hold the two magnetic keychains with the north pole "N" over the N1 and N3 button at the same time for 3 seconds. The demo mode makes the sensor open and close the valve with uninterrupted cycles. The display shows "Test Loop." To exit demo mode, hold the two magnetic buttons against N1 and N2 buttons again.



### Reset Password:

It is necessary to have two magnetic keychains to reset the password. Enter in Menu Configuration (ConF) activating S2 button. The display shows "Password" blinking five times and shows "0000." Hold the two magnetic keychain over N1 and N3 at the same time. The password is disabled and the display shows "Tolerance."



**NOTE:** If you want to set a new password go to "Pass Set" menu.

# Maintenance Instructions Describing the Menu Options

## 13 - Describing the Menu Options

Below is described in detail each menu option. A full flow chart is available on-line at [www.saundersI-VUE.com](http://www.saundersI-VUE.com).

**Conf** **Conf:** To enter into configuration mode, hold the magnetic keychain with the south pole "S" near the "S2" magnetic button for more than 3 sec. This mode allows the user to configure all the functions of the sensor.

**tolE** **Tolerance Alarm:** The user can set the tolerance alarm in the open position (displayed as "H") at 10%, 20% or 30% of full open. The closed position tolerance alarm (displayed as "L") can be set at 10%, 20%, 30%, 40%, or 50% of full closed position. This feature compensates for varying process conditions and/or air supply pressure and reduces false indications.

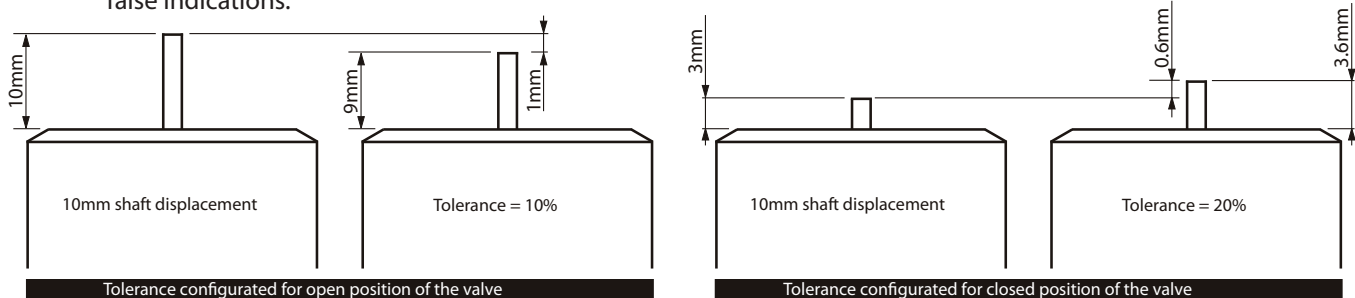

**CYCL** **Cycle Time:** In the self-calibration cycle, the sensor records opening and closing time for the valve. The user can configure the sensor to generate an alarm when this recorded time is exceeded by 20%, 30%, 40%, or 50% (AL 4) or disable the alarm (A\_OF).

CYCLE t InE 30 40 50 A\_of

**PARt** **Partial Cycle Counter:** This option causes the sensor to generate an alarm when the partial cycle counter reaches a set number of cycles (AL 1), notifying the operator that it is time to perform preventive maintenance or other action. It is possible to activate the alarm (A\_ON), cancel the alarm (C\_AL), and disable the alarm (A\_OF). In the C\_AL option the sensor disables the alarm and cancels the counting cycles.

PARtIAL\_Counter A\_on C\_AL A\_of

**DAY** **Day Alarm:** This option causes the sensor to generate an alarm after a set number of days has elapsed.(AL 2). This alarm can be very useful in carrying out preventive maintenance or other actions. The user can, for example, configure the sensor to generate the alarm 30 days after installation and start of operation of the sensor. The day alarm can be reset (CLR) to a new number of days elapsed.

DAY ALArnE A\_on 0030 A\_of CLR

**DATE** **Date Alarm:** Similar to the previous, this alarm allows the user to set a specific day, month, and year in the future for the sensor to generate an alarm (AL3).

DATE ALArnE on 1302 2012 off  
Day Month Year



# Maintenance Instructions Describing the Menu Options

**DISP** **Display Setting:** This option allows the user to view content of Smart Window display.

- **Worked Days**

If this option is selected, the Smart Window shows the number of days in which the sensor has been in operation.

- **Partial Counter**

If this option is selected, the Smart Window shows the number of partial cycles of the valve (see section 4.14 on page 6).

- **Total Counter**

If this option is selected, the display will show the total number of cycles of the valve (see section 4.15 on page 6).

- **Valve Position**

If this option is selected, the display shows the valve position. Specifically, the dashes above indicate that the valve is open and the dashes below show that the valve is closed, dash in the middle when halfway, effective when valve moves slowly.

In operation mode, the display shows the selected option. To know what is being displayed, the user must approach the magnetic keychain with north pole "N" near the N3 magnetic button, and the display will show the selected option for 5 seconds and then revert back to the operation display.

For example, the display shows the number 40; to know the meaning of the number, approach the magnetic keychain with the north pole "N" near the N3 magnetic button and the sensor will show, for example, the word "Day," indicating that the sensor is operating on the valve for 40 days.

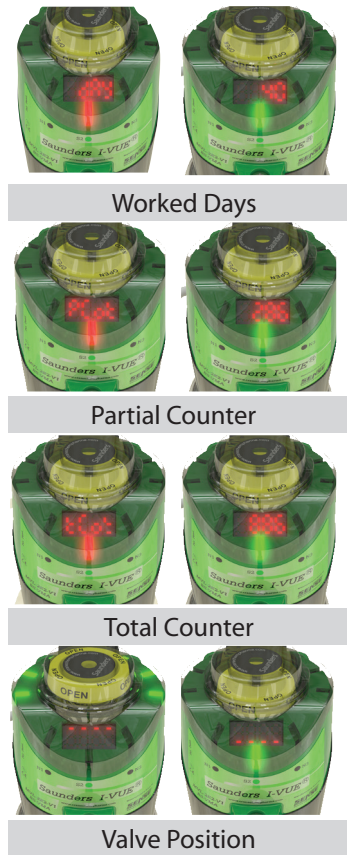

**OUT** **Output Setting:** This option allows the user to define whether the valve is held in the normally open ("nO") or normally closed ("nC") position. For example: If you require output "logic 1" on a closed valve, select "nC".



**SLEEP** **Sleep Mode:** This mode allows the user to set a time ranging from 5 to 15 minutes to turn off the lights and the display during time when the magnetic buttons are not activated. This option should be selected to save energy or for places where local indication is not important to the operating of the system.

In case of alarm, the LEDs above the N3 magnetic button remain blinking green / red.



**SELF** **Self-Calibration:** Self-calibration commands the sensor to learn the opening and closing positions of the valve and the cycle time over 3, 5, or 10 cycles.

**!** **NOTE:** The greater the number of cycles, the greater accuracy in the detection of position. To perform the self-calibration, hold the magnetic keychain with the north pole "N" near the N3 magnetic button for 3 seconds when the sensor is in operation mode. The display will show the message "Self-Calibration."





# Maintenance Instructions Describing the Menu Options

**Hand Calibration:** The user can set the open and closed positions of the sensor manually. To manually calibrate the sensor, cycle the valve to the desired position and confirm its position by approaching the magnetic keychain with the south pole "S" near the S2 magnetic button. This must be done for both open and closed positions.

Hand CAL IbrAt Ion Sure LL HL



**Solenoid Alarm:** The sensor can generate a short-circuit alarm (AL 8) or an alarm if the cable or coil of the integral solenoid is damaged (AL9). If the sensor is used without an integral solenoid valve, this alarm should be disabled. Choosing "SSol" in the menu turns on the alarm for self calibration (for use with integral solenoid & Self Calibration); "HSol" turns the alarm off (for use with remote solenoid & Hand Calibration)

Sol SSol HSol



**Pass Set:** The password is indispensable to protect the configuration and prevent unauthorized people from making changes. The operator selects a 4-digit password. When I-VUE is password protected, the password must be entered via the magnetic keychain in order to enter the configuration menu.

PASS Set on 0000 off



**Clock Set:** It is necessary for the date and hour of the sensor be correct, otherwise the "Date Alarm" will not work properly. Through this option, you can set the hour, day, month, and year.

Clock Set Hour 1230 date 3009 2011  
Hour Min Day Month Year



**Total Counter:** The total counter is the lifetime meter of the valve and must be reset whenever the sensor is installed on a new valve.

total Counter 2800 Sure 0000



**Factory Settings:** This option erases sensor memory and restores all configurations and settings to factory parameters described in the section 4.17 on page 7.

FACTory Set Sure



**End:** The word "End" appears on the display to indicate when the configuration is complete or interrupted by the user.

**Alarms:** All alarms generated by the sensor are shown once on the Smart Window display and the LED above the N3 button keeps blinking green / red. To view the alarm codes, just position the magnetic keychain with the north pole "N" of the N3 magnetic button and the display will show the alarm code for 5 seconds.

# Maintenance Instructions I-VUE Alarm Codes

## 14 - I-VUE Alarm Codes

I-VUE Type	Alarm Code	Alarm Name	Alarm Description	When Does It Occur?
Point to Point AS-Interface DeviceNet	AL 1	Partial Counter Alarm	The I-VUE increases the partial counter after each cycle	When the partial count reaches a limit value defined by the user
	AL 2	Worked Days Alarm	The I-VUE counts the number of days since this alarm was set (even without power)	When the number of days reaches a limit value defined by the user
	AL 3	Date Alarm	The I-VUE signals an alarm at a specific date	When the date reaches a date limit defined by the user
	AL 4	Open / Close Time Alarm	The I-VUE stores the time required to open and close the valve during Self Calibration	The time to open or close the valve exceeds the memorised time (plus any tolerance configured)
	AL 5	Solenoid Command	The I-VUE monitors the solenoid command	The valve did not move to the new required position
	AL 6	Stroke Out of Range	The I-VUE stores the maximum height of the valve during travel	The valve height reached exceeds the stored value
	AL 7	Unexpected Position Change	The I-VUE continuously monitors valve position	An unexpected change from open to close (or vice versa) has been detected
	AL 8	Solenoid Coil Short Circuit	The I-VUE monitors the solenoid command	The solenoid coil has short circuited
	AL 9	Solenoid Coil Broken	The I-VUE monitors the solenoid command	The solenoid coil has broken
	AL 10	Internal Temperature Alarm	The I-VUE monitors the internal electronic module temperature	The internal temperature of the internal electronic module has exceeded 90 °C
Point to Point	AL 11	P2P Output alarm	The I-VUE monitors the P2P output	The P2P output (1 or 2) has short circuited
DeviceNet	AL 13	Duplicate Address Alarm	The I-VUE has detected a device with the same address in the network	There is another device with the same address in the network
	AL 14	Address Alarm	The I-VUE has detected the sensor is not addressed	The sensor not addressed
AS-Interface	AL 15	Network Power Supply Out of Range	The I-VUE monitors the power supply received at the sensor	When the power supply is above or below 31.6 Vdc

I-VUE Type	Alarm Code	What to do?	Where To Do It	Factory Default
PNP or AS-Interface or DeviceNet	AL 1	1- Increase the limit value 2- Reset the partial counter 3- Turn OFF or CANCEL the alarm.	Partial counter function on menu	OFF
	AL 2	1- Increase the limit value 2- Turn OFF the alarm	Day function on menu	OFF
	AL 3	1- Increase the date of the alarm 2- Turn OFF the alarm	Date function on menu	OFF
	AL 4	1- Increase the percentage of time 2- Turn OFF the alarm.	Cycle Time function on menu	OFF
	AL 5	1 - Check if the solenoid operates manually 2 - Check air connections	In field	OFF
	AL 6	1 - Check actuator for damage 2 -Perform self-calibration again	In field	ALWAYS ON
	AL 7	1 - Check if the solenoid operates manually 2 - Check air connections	Self Calibration Menu	ALWAYS ON
	AL 8	1 - Check solenoid connections	In field	ALWAYS ON
	AL 9	1 - Check solenoid connections	In field (inside I-VUE)	ALWAYS ON
	AL 10	1 - Check the temperature of the I-VUE 2 - Check the power supply	In field (inside I-VUE)	ALWAYS ON
PNP	AL 11	1 - Check the output wires	In field	OFF
DeviceNet	AL 13	1 - Change sensor address	In field (inside I-VUE)	ALWAYS ON
	AL 14	1 - Set sensor address	In field	ALWAYS ON
AS-Interface	AL 15	1 - Check if the power supply is within the specified limits	In field	ALWAYS ON

**GENERAL NOTES:**  
**1:** After restoring factory settings one must perform self calibration on the I-VUE.  
**2:** Default factory Open and Closed tolerance: 20%.  
**3:** Partial counter default to 50,000 cycles when first turned on.





Crane ChemPharma & Energy  
 Crane Process Flow Technologies Ltd.  
 Grange Rd,  
 Cwmbran, Gwent NP44 3XX  
 Tel: +44 1633 486666  
 Fax: +44 1633 486777  
 SaundersOrders@CraneCPE.com  
 SaundersQuotes@CraneCPE.com  
 www.cranecpe.com



Crane ChemPharma & Energy  
 4526 Research Forest Dr, Suite 400  
 The Woodlands, TX 77381 • USA  
 Tel: (936)-588-8360

Crane ChemPharma & Energy  
 4444 Cooper Road,  
 Cincinnati, Ohio 45242 U.S.A.  
 Tel.: +1 513 745 6000  
 Fax.: +1 513 745 6086

Crane Process Flow Technologies SPRL/BV  
 Avenue Franklin No. 1  
 Wavre, B-1300 , Belgium  
 Tel.: +32 10 8184 44  
 Fax.: +32 10 8184 58

Crane Process Flow Technologies (India) Ltd  
 Solitaire, 5th & 6th Floor, S. No. 131/1+2 ,  
 ITI Road, Aundh, Pune - 411007, India  
 Tel.: +91 20 3056 7800  
 Fax.:+91 20 3056 7812

**brands you trust.**



COMPAC-NOZ®



DEPA®

ELRO®

DUO-CHEK®



NOZ-CHEK®



RESISTOFLEX®



STOCKHAM®



UNI-CHEK®

w.ta.®

XOMOX®

Crane Co., and its subsidiaries cannot accept responsibility for possible errors in catalogues, brochures, other printed materials, and website information. Crane Co. reserves the right to alter its products without notice, including products already on order provided that such alteration can be made without changes being necessary in specifications already agreed. All trademarks in this material are property of the Crane Co. or its subsidiaries. The Crane and Crane brands logotype, in alphabetical order, (ALOYCO®, CENTER LINE®, COMPAC-NOZ®, CRANE®, DEPA®, DUO-CHEK®, ELRO®, FLOWSEAL®, JENKINS®, KROMBACH®, NOZ-CHEK®, PACIFIC VALVES®, RESISTOFLEX®, REVO®, SAUNDERS®, STOCKHAM®, TRIANGLE®, UNI-CHEK®, WTA®, and XOMOX®) are registered trademarks of Crane Co. All rights reserved.