

# TECHNICAL DATASHEET

**MAXIMIZING VALVE LIFE IN EXCESS OF 3 MILLION CYCLES**

## **SAUNDERS ANGLE SEAT VALVES**

APU/AKU SERIES (ASME BPE)

Normally Closed/Normally Open/Double Acting

# Contents

Materials of Construction.....Page 2

Dimensions.....Pages 3-4

Installation and Orientation..... Page 5

Actuator Selection/Performance Graphs.....Page 6 - 17

Product Coding/How to Order.....Pages 18-19

## Product Breakdown

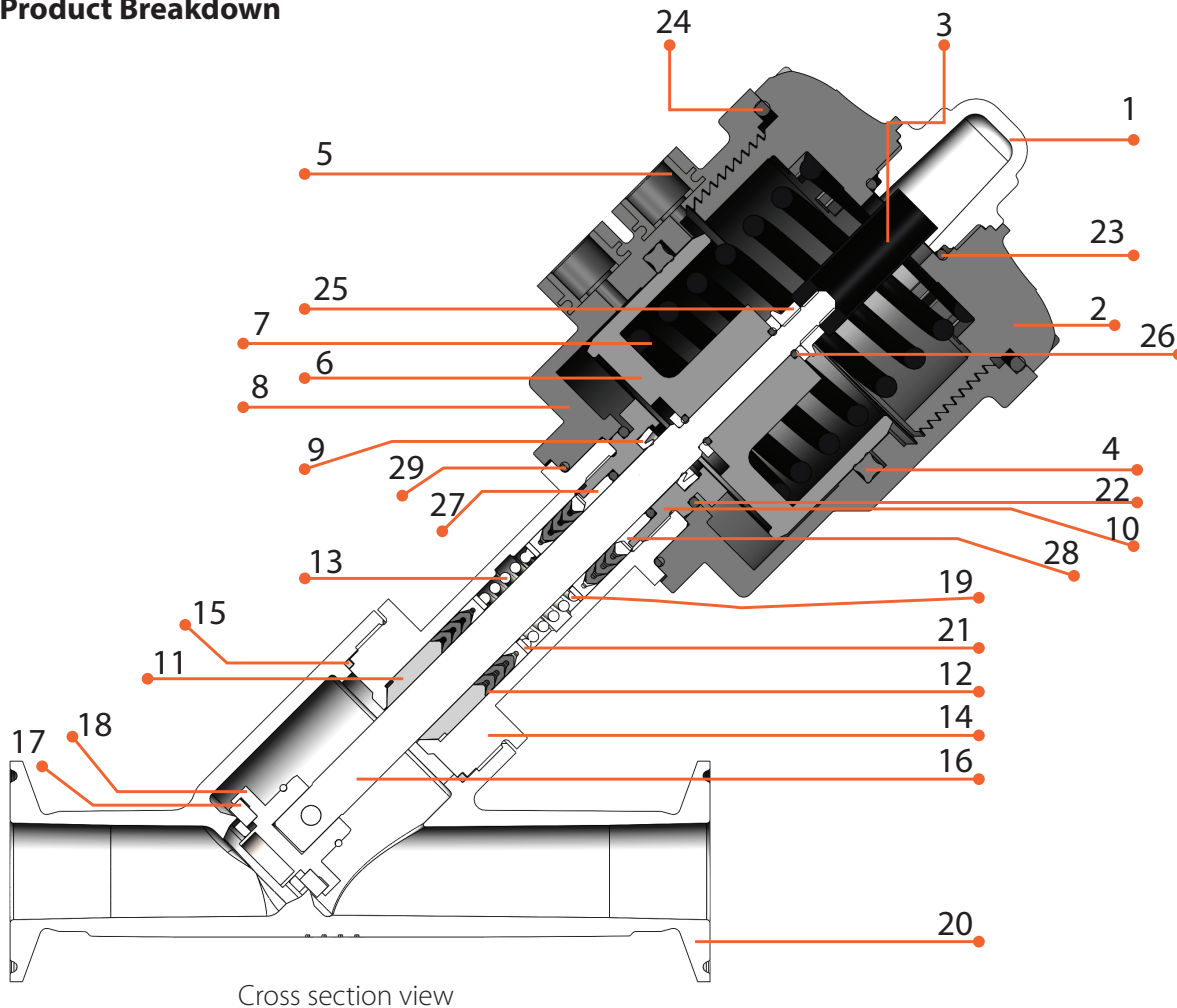

## Components

Sr. no	DESCRIPTION	MATERIAL	Pos. No.	Qty.
1	Body	CF3M (SS316L)	20	1
2	Indicator Dome	Polycarbonate	1	1
3	Operator Cover	Glass filled Nylon	2	1
4	Open Indicator	ABS	3	1
5	Piston Seal	NBR	4	1
6	Insert	SS316L	5	2
7	Piston	Aluminium Anodised	6	1
8	Piston Spring	Carbon Steel (IS4454 GR II)	7	1
9	Piston Inner Spring	Carbon Steel (IS4454 GR II)	7A	1
10	Operator	Glass filled Nylon	8	1
11	Shaft Seal	NBR	9	1
12	Hex Assembly	Aluminium hard Anodised	10	1
13	Shaft bearing	PTFE/PEEK	11	1
14	Gland Packing	PTFE/PEEK	12	6
15	Gland Spring	SS 302	13	1
16	Sleeve	CF3M (SS316L Cast- 1.4435)	14	1
17	Body Seal	PTFE	15	1
18	Shaft	SS316L (1.4404)	16	1
19	Washer	SS 304	21	2
20	Gland Packing Retainer	PTFE	19	1
21	Operator Seal	NBR	22	1
22	Dome Nut Seal	NBR/Viton	23	1
23	Operator Cover Seal	NBR/Viton	24	1
24	Hex Flange Nut	Zinc	25	1
25	Seal	NBR/Viton	26	2
26	Bush	PTFE	27	1
27	Bush Seal	NBR/Viton	28	1
28	Sleeve Seal	NBR/Viton	29	1
29	Seat holder assembly	SS 316L	17	1
30	Retaining Ring	SS 302	18	1
31	Body Seal	PTFE	15	2
32	Shaft Seal	NBR	9	1
33	Operator Seal	NBR	22	1
34	Dome Nut Seal	NBR/Viton	23	1
35	Operator Cover Seal	NBR/Viton	24	1
36	Seal	NBR/Viton	26	2
37	Bush Seal	NBR/Viton	28	1
38	Sleeve Seal	NBR/Viton	29	1

# Dimensions

## APU Series (Butt Weld)

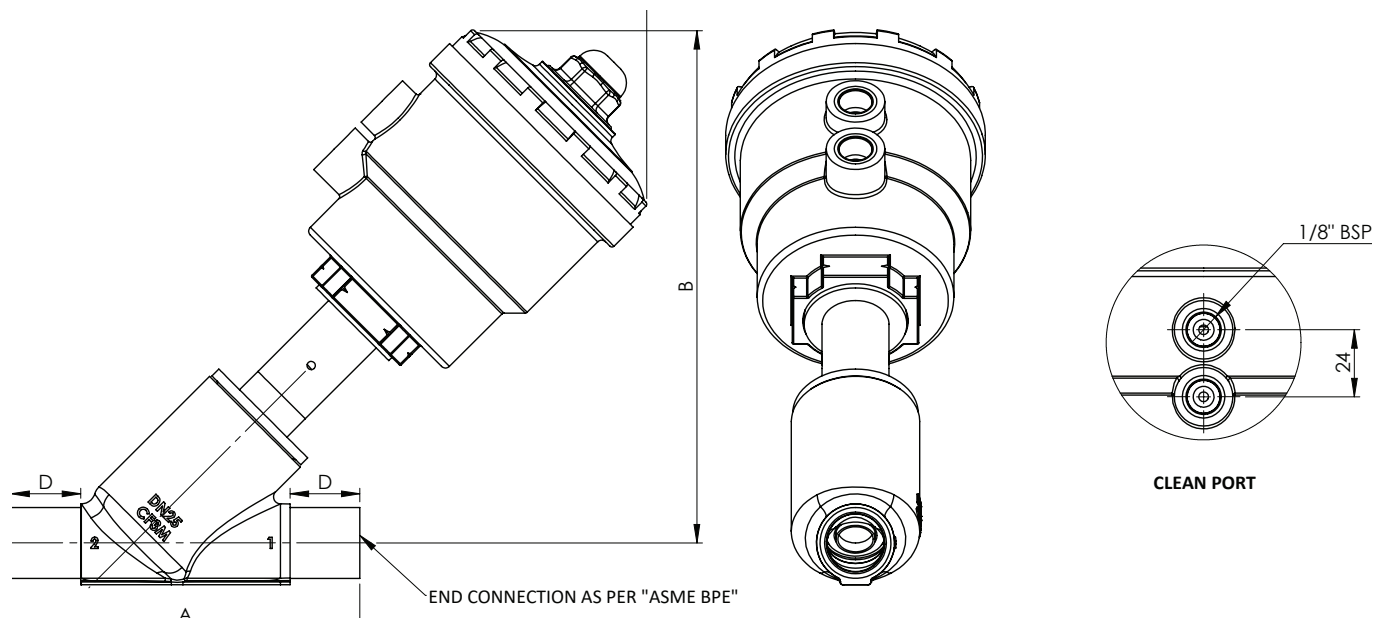

Series Number	Valve Size	Dimensions in mm			
		A	B	C	D
1	DN15	113	168	206	25
2	DN20	123	167	209	
3	DN25	125	184	228	
4	DN40	160	221	268	
5	DN50	180	271	325	

# Dimensions

## AKU Series (ASME BPE Hygienic Clamp)

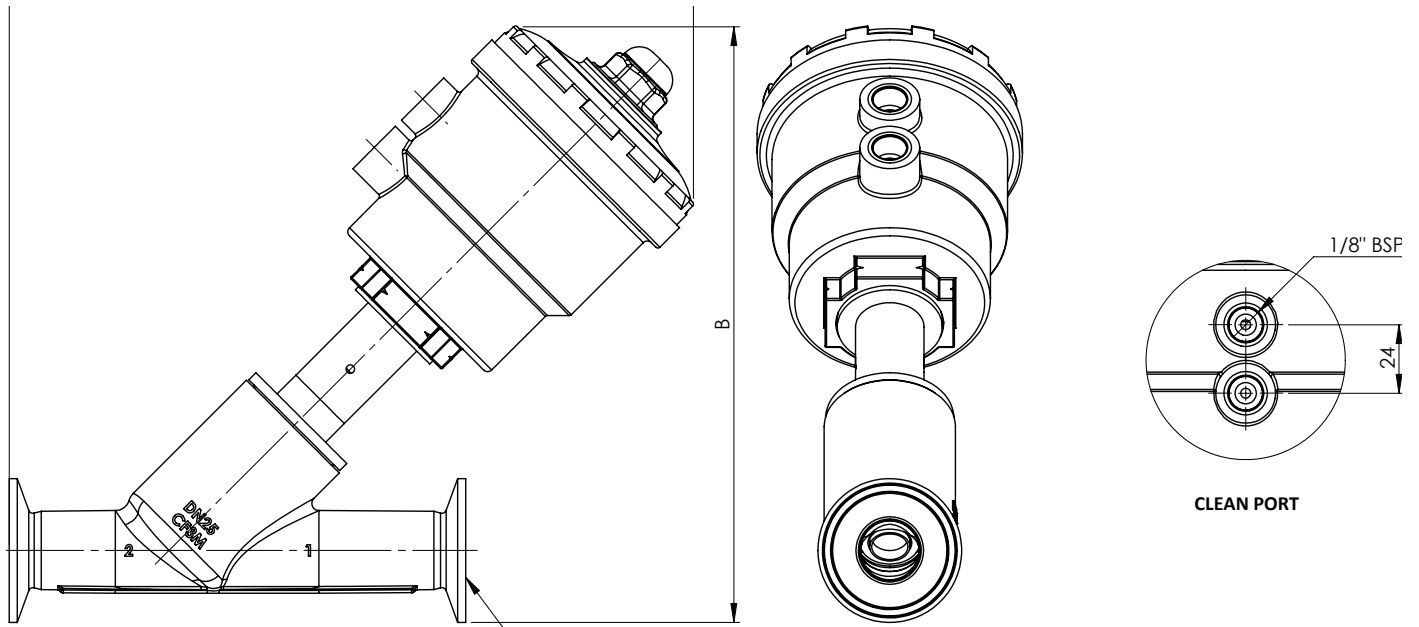

Series Number	Valve Size	Dimensions in mm		
		A	B	C
1	DN15	130	180	215
2	DN20	150	179	220
3	DN25	160	209	238
4	DN40	200	247	289
5	DN50	230	303	343

## Product Overview

### Installation and Recommended Flow Direction

Recommended flow direction is dependent on media type, operating mode of actuator and system requirements

### Media Type

Liquid  
Gas  
Steam  
Air  
Vacuum

### Operating Mode

Normally Close NC  
Normally Open NO  
Double Acting DA

### Liquid based Media

For optimum service lifetime and avoidance of water hammer (liquid applications), recommended installation is with the media flow below the seat. If the valve is incorrectly installed with flow above the seat, water hammer may occur causing damage to the valve and functioning of the system. Flow over the seat may lead to increased wear and possible premature valve failure

### Compressible Media

Compressible media, such as gases and steam, may be installed in either orientation but the recommended orientation is above the seat

### Operating Air Pressure

Operating air pressure requirement will depend on the working line pressure, installation (flow direction over or under the seat), and actuator mode of operation. Please consult performance graphs for verification

### Flow Orientation Indicators

To assist with optimum installation in accordance with above guidelines, "flow orientation indicators" are permanently marked on the body

- 1 Inlet "Below Plug"
- 2 Inlet "Above Plug"

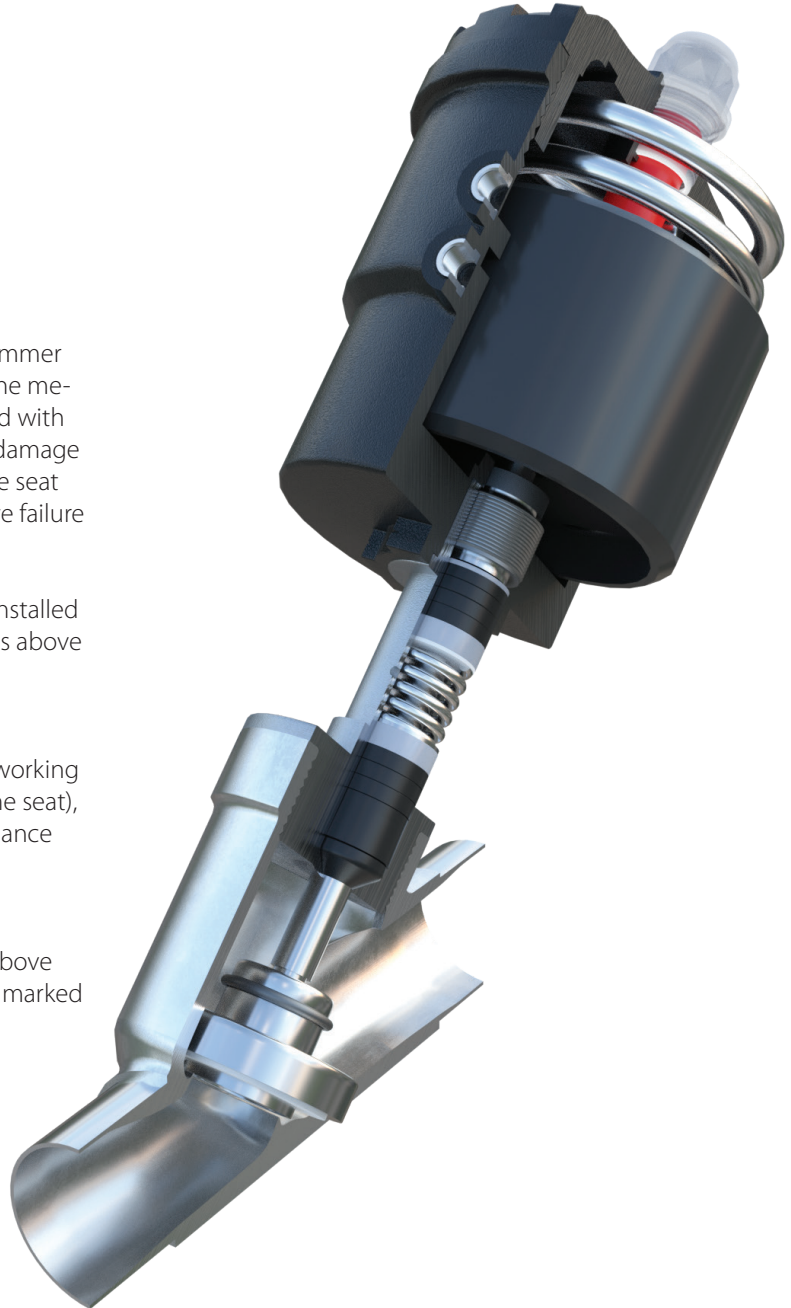

# Installation and Orientation

## Normally Closed Actuator

### RECOMMENDED INSTALLATION

#### PRESSURE ABOVE SEAT

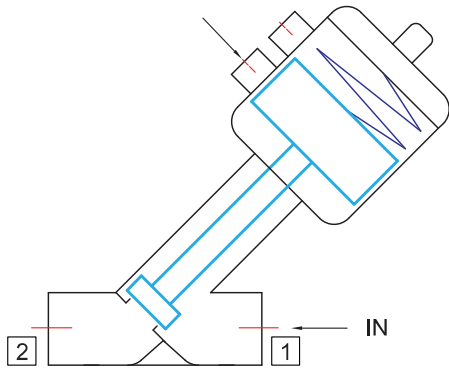

#### MEDIA

Gas, Steam, Air, Vacuum, LPG

#### PRESSURE BELOW SEAT

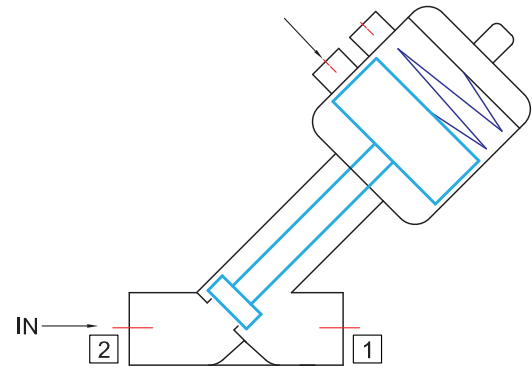

#### MEDIA

Gas, Air, Water, Vacuum, Oil, Liquid, Fuel

## Normally Open Actuator

### CONNECTION DETAIL/ RECOMMENDED INSTALLATION

#### PRESSURE BELOW SEAT

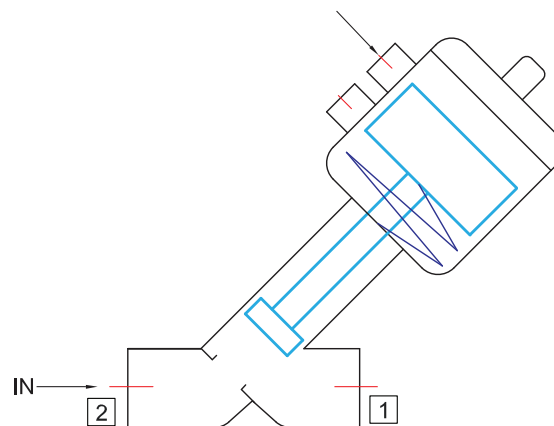

#### MEDIA

Steam, Air, Oil, Water, Fuel Gas and Liquid, Vacuum

# Installation and Orientation

## Double Acting Actuator

### CONNECTION DETAIL/ RECOMMENDED INSTALLATION

**Normally close  
Pressure Above Seat**

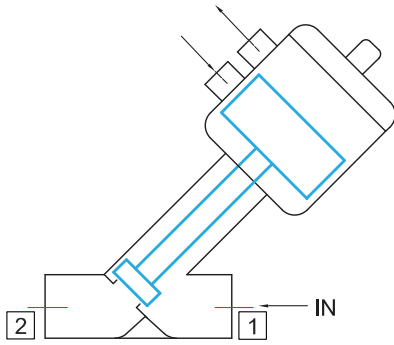

**MEDIA**

Gas, Steam, Air, Vacuum,  
LPG

**Normally close  
Pressure Below Seat**

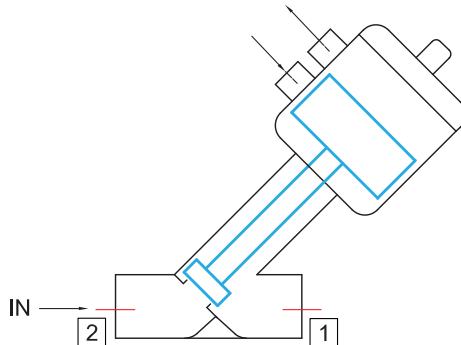

**MEDIA**

Gas, Air, Water, Vacuum, Oil,  
Liquid, Fuel

**Normally open  
Pressure Below Seat**

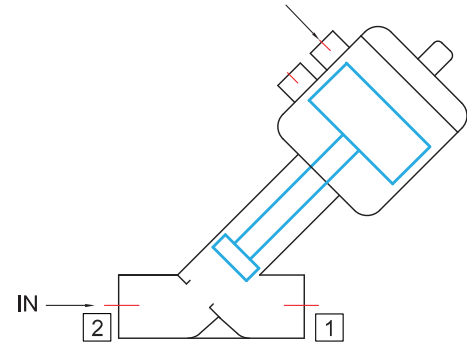

**MEDIA**

Steam, Air, Oil, Water, Fuel  
Gas and Liquid, Vacuum



# Pressure and Temperature Ratings

## Valve Selection

When selecting the required configuration of Angle Seat Valve, the following factors should be taken into account:

- Process Media
- Operating and Ambient temperatures (min/max)
- Flow direction, mounting position and size
- Valve seat and gland packing seal dependent on process parameters and media
- Required mode of operation
  - Normally Open,
  - Normally Closed,
  - Double Acting
- Operating Air Pressure (min/max) for Actuator
- Compressed Air quality for pneumatically operated valves
- Please consult operating parameters on the following pages to validate correct actuator selection

## PED

Angle Seat Valves intended to be installed in an area where PED is applicable

- Valve should be connected to a lower fluid pressure as indicated in the table below or as detailed in published operating parameters.

## Pressure/Temperature Chart

Pressure and Temperature Chart								
DN	CLASS	MAXIMUM PRESSURE (bar)						PED Applicable
		-29° C to 38° C	50 °C	100 °C	150 °C	180 °C	200 °C	
15	B40	≤25	≤25	≤25	≤25	≤25	≤25	Not applicable
20	B40	≤25	≤25	≤25	≤25	≤25	≤25	Not applicable
25	B40	≤25	≤25	≤25	≤25	≤25	≤25	Not applicable
32	B25	≤24.5	≤23	≤20	≤19	≤18	≤17	Yes
40	B20	≤19.6	≤19	≤16	≤15	≤14	≤14	Yes
50	B25	≤24.5	≤23	≤20	≤19	≤18	≤17	Yes
65	B40	≤25	≤25	≤25	≤25	≤25	≤25	Yes
80	B40	≤15	≤15	≤15	≤15	≤15	≤15	Yes
Pressure Temperature Compatibility Chart (for AKU)								
DN	CLASS	MAXIMUM PRESSURE (bar)						PED Applicable
		-29° C to 38° C	50 °C	100 °C	121 °C	--	--	
15	B40	13.7	13.4	11.9	11.3	--	--	Not applicable
20	B40	13.7	13.4	11.9	11.3	--	--	Not applicable
25	B40	13.7	13.4	11.9	11.3	--	--	Not applicable
32	B25	13.7	13.4	11.9	11.3	--	--	Yes
40	B20	13.7	13.4	11.9	11.3	--	--	Yes
50	B25	13.7	13.4	11.9	11.3	--	--	Yes
65	B40	13.7	13.4	11.9	11.3	--	--	Yes
80	B40	13.7	13.3	11.2	10.3	--	--	Yes

## Pressure and Temperature Ratings

Pressure Temperature Compatibility Chart ( APU ) 0								
DN	CLASS	MAXIMUM PRESSURE (bar)						PED Applicable
		-29° C to 38° C	50 °C	100 °C	150 °C	180 °C	200 °C	
15	B40	≤25	≤25	≤25	≤25	≤25	≤25	Not applicable
20	B40	≤25	≤25	≤25	≤25	≤25	≤25	Not applicable
25	B40	≤25	≤25	≤25	≤25	≤25	≤25	Not applicable
32	B25	≤24.5	≤23	≤20	≤19	≤18	≤17	Yes
40	B20	≤19.6	≤19	≤16	≤15	≤14	≤14	Yes
50	B25	≤24.5	≤23	≤20	≤19	≤18	≤17	Yes
65	B40	≤25	≤25	≤25	≤25	≤25	≤25	Yes
80	B40	≤15	≤15	≤15	≤15	≤15	≤15	Yes

Pressure Temperature Compatibility Chart (for AKU)								
DN	CLASS	MAXIMUM PRESSURE (bar)						PED Applicable
		-29° C to 38° C	50 °C	100 °C	121 °C	--	--	
15	B40	13.7	13.4	11.9	11.3	--	--	Not applicable
20	B40	13.7	13.4	11.9	11.3	--	--	Not applicable
25	B40	13.7	13.4	11.9	11.3	--	--	Not applicable
32	B25	13.7	13.4	11.9	11.3	--	--	Yes
40	B20	13.7	13.4	11.9	11.3	--	--	Yes
50	B25	13.7	13.4	11.9	11.3	--	--	Yes
65	B40	13.7	13.4	11.9	11.3	--	--	Yes
80	B40	13.7	13.3	11.2	10.3	--	--	Yes

### Pressure Temperature Compatibility (PTFE/PEEK)

Pressure Temperature Compatibility Chart (for PTFE & PEEK material)								
DN (mm)	MATERIAL	MAXIMUM PRESSURE (bar)						
		-29° C to 38° C	50 °C	100 °C	150 °C	180 °C	200 °C	
15 to 80	PTFE	68	67	48	30	18	---	
65 to 80	PTFE	48	48	48	30	18	---	
12 to 50	PEEK	102	102	102	102	102	68	
65 to 80	PEEK	48	48	48	48	48	48	

**Notes:**

1. If valves are to be operated at a higher pressure, or reduced ambient/fluid temperature, refer to following tables or contact Saunders, stating the temperature limit at which the valve will operate.
2. Pressure temperature Compatibility chart derived from Table 30 of EN 12516-1. Operating Parameters are in accordance with Table 30 of EN 12516-1.
3. Pressure Temperature Compatibility Chart derived from Table DT-2 Hygienic unions of ASME BPE. Operating Parameters for (AK series) is in accordance with Table DT-2 Hygienic unions of ASME BPE.
4. For temperatures up to 180°C select PTFE (White) seat/seal. For temperatures above 180°C select PEEK (Virgin).

# General Maintenance

## General Maintenance

- Do not dismantle or loosen any valve components during service and always ensure that pressure is removed prior to any maintenance taking place to avoid damage to the valve or maintenance personnel.
- Do not perform maintenance on any valve in place. Remove valve from service and undertake maintenance under safe working conditions.
- Always ensure operating air supply is removed prior to removal of the valve from service.
- It is recommended that all seals are replaced in the event of a single seal failure. This will ensure trouble free operation and avoid premature failure.
- It is recommended that only Molykote 111 is used in seal lubrication. The use of any other form of grease will lead to premature failure of the seals.
- The use of a light soap detergent is recommended when cleaning of the valve is required. Do not use kerosene, diesel or petrol to clean.
- Always ensure all components are free from dust, dirt, lint or metal burrs.
- When fitting O-Rings ensure that they are free from twisting and pinching when assembling mating components to avoid damage and failure during service.
- Ensure during assembly that mating parts are pushed together without a twisting motion being applied. This will ensure no damage occurs.
- Genuine Saunders spare parts will ensure trouble free operation and avoid premature failure.
- Always follow the correct mounting/installation procedures when re-assembling valves.
- Use only recommended or specified line media during the operation of the valve to avoid damage to internal valve components and valve body.
- Avoid contact of the valve with excessive external heat, such as those associated with fire, to prevent damage to internal rubber components.

## Torque Specification

Part no.	Part (NW)	Size	Torque (Nm)
16	15/20/25	M6 x 1.0	≤5
	32/40/50/65/80	M10 x 1.5	≤15
14	15	M28 x 1.5	≤90
	20	M32 x 1.5	≤100
	25	M40 x 1.5	≤120
	32/65/80	M48 x 1.5	≤135
	40	M58 x 1.5	≤150
	50	M70 x 2	≤200
	Flange nut-bolt (class-150/300) (NOTE-Stainless Steel having tensile strength greater than 52kg/mm <sup>2</sup> or steel fastener grade 8.8 Or better.)	M14 x 2	≤40
		M18 x 2.5	≤90
		M20 x 2.5	≤140

# Operating/Performance Parameters

## Single Acting Normally Closed F1/F6

### Single Acting Normally Closed F1/F6

Function	DN	Actuator Ø	Single acting Normally Closed Bi-Directional					
			F1: Pressure above plug			F6: Pressure below plug		
			Pilot Pressure	Fluid Pressure (bar)		Pilot Pressure	Fluid Pressure (bar)	
			Up to 10 bar	APU	AKU	Up to 10 bar	APU	AKU
F1	12	50	4.6	0	0	4.6	0	0
			5	16	16	4.4	16	16
			5.4	25		4.4	25	
F1	20	50	4.6	0	0	4.6	0	0
			5	6	6	4	8	8
			6	25	16			
F6	20	63	5.4	0	0	5.4	0	0
			5.6	16	16	4.9	16	16
			5.7	25		4.4	25	
F1	25	50	4.6	0	0	4.6	0	0
			5	2.3	2.3	4.2	5	5
			8.2	25	16			
F6	25	63	4.5	0	0	4.5	0	0
			5	7.5	7.5	4.4	11	11
			6.1	25	16			
F1	40	63	3	0	0	3	0	0
			5	5.5	5.5	2	2	2
			10	21	16			
F6	40	63	5.4	0	0	5.4	0	0
			8.4	12	12	4.8	4	4
			10	18				
F1	40	90	2.3	0	0	2.3	0	0
			4.2	16	16	1.4	1.4	1.4
			5.3	25				
F6	40	90	4.5	0	0	4.5	0	0
			5	7.5	7.5	4.4	8	8
			6.1	25	16			
F1	50	63	2.8	0	0			
			5	4	4			
			10	14	14			

# Operating/Performance Parameters

## Single Acting Normally Closed F1/F6

F1	50	90	2.3	0	0			
			5	9.5	9.5			
			9	25	16			
F6	50	90	6	0	0	6	0	0
			6.8	14	14	4.5	6	6
			7.5	25				
F1	50	110	1.4	0	0			
			4.2	16	16			
			5.8	25				
F6	50	110	4.5	0	0	4.5	0	0
			5	4	4	4.4	9	9
			7.3	25	16			

### Single Acting Normally Closed F1/F6

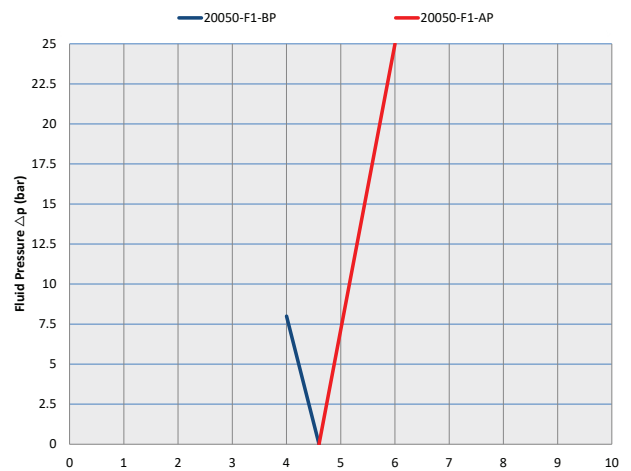
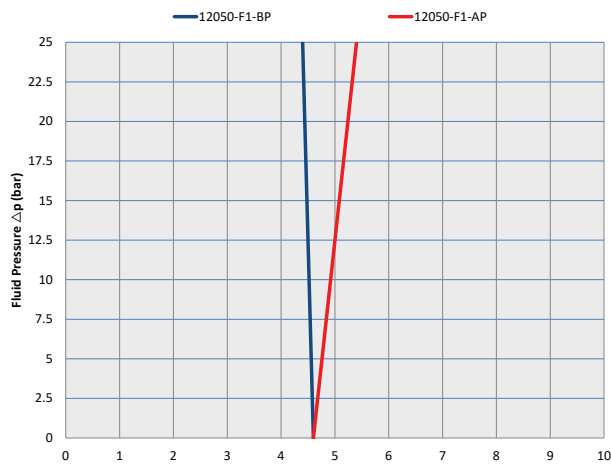

# Operating/Performance Parameters

## Single Acting Normally Closed F1/F6

### Single Acting Normally Closed F1/F6

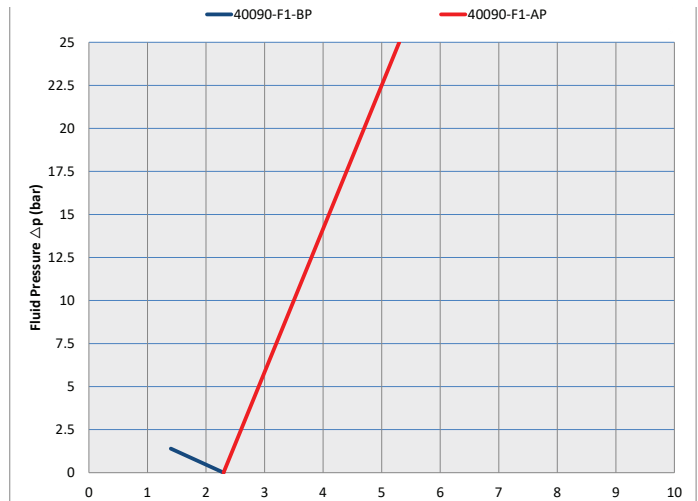
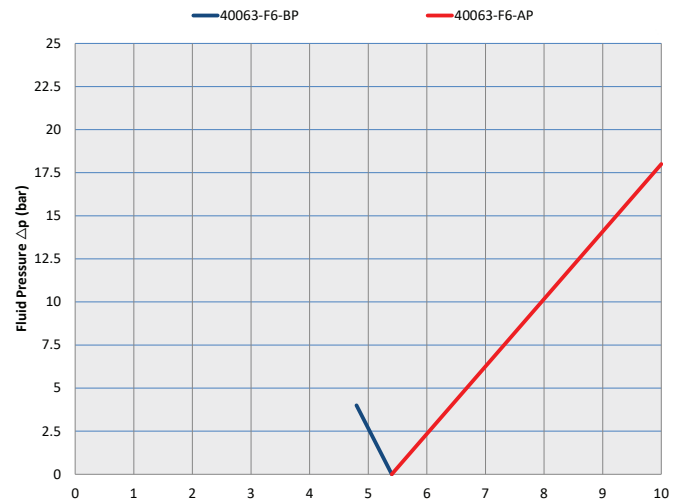
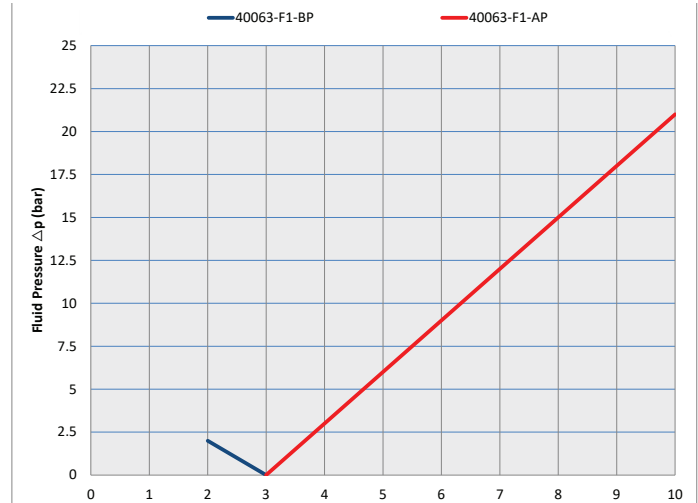
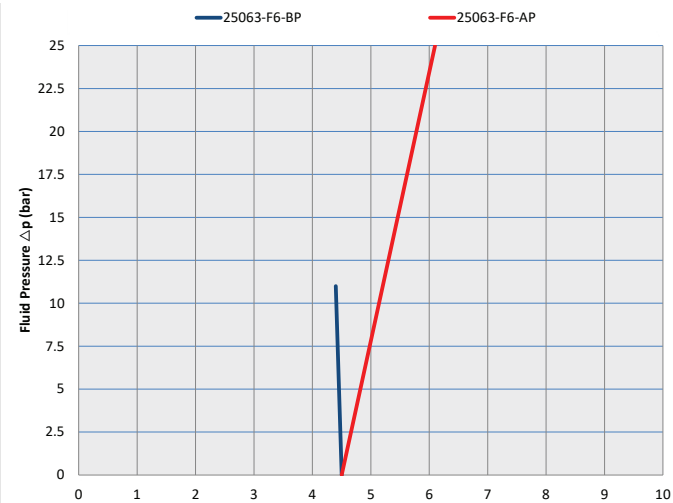
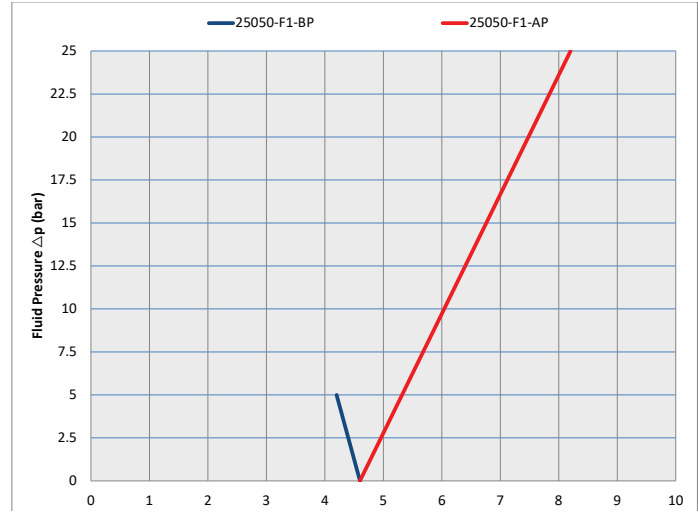
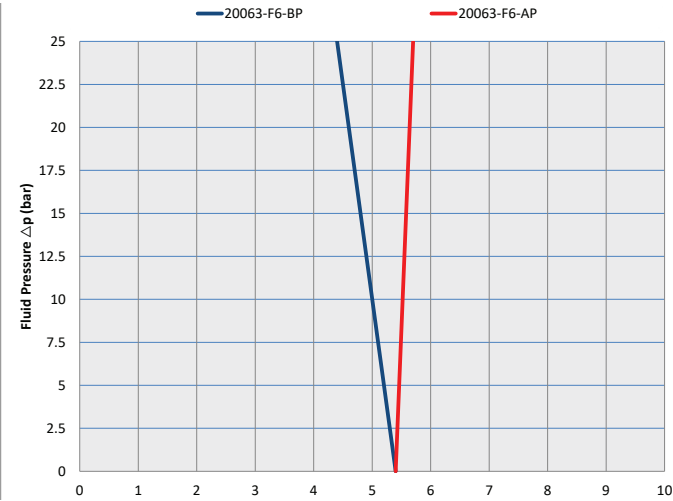

# Operating/Performance Parameters

## Single Acting Normally Closed F1/F6

### Single Acting Normally Closed F1/F6

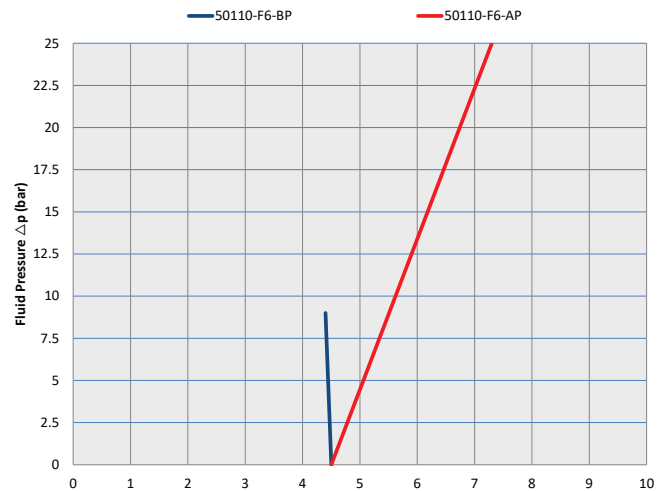
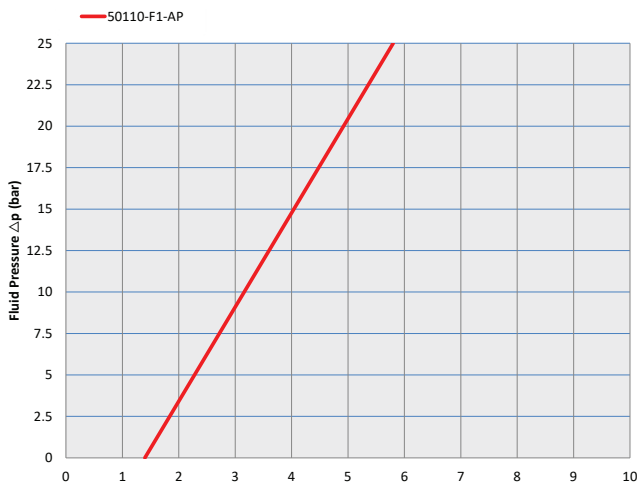
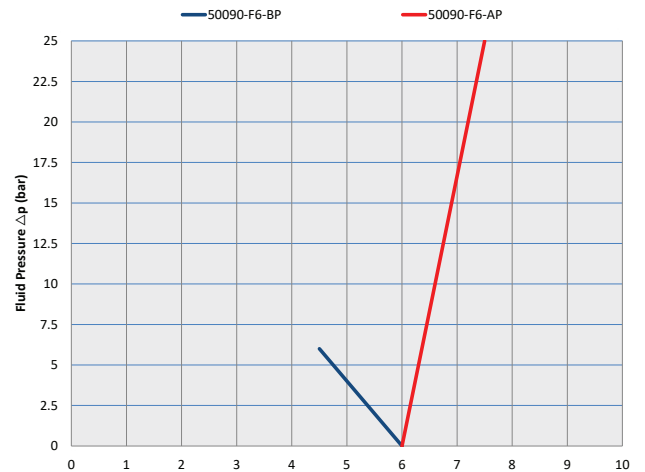
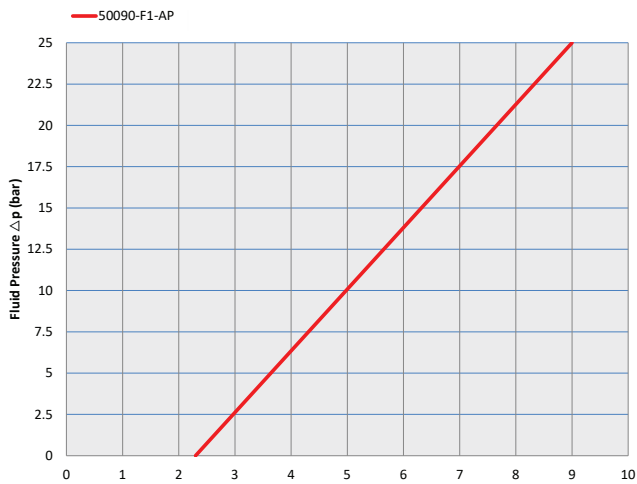
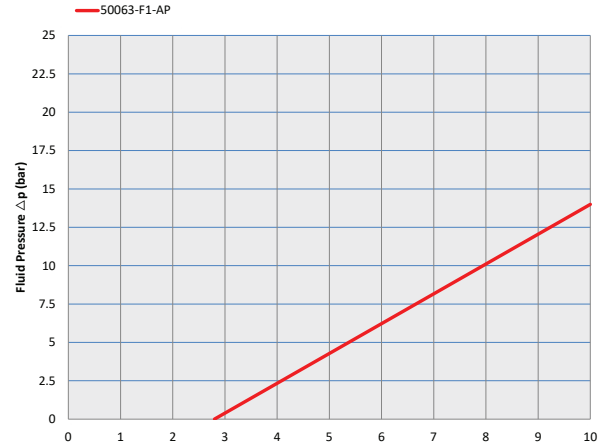
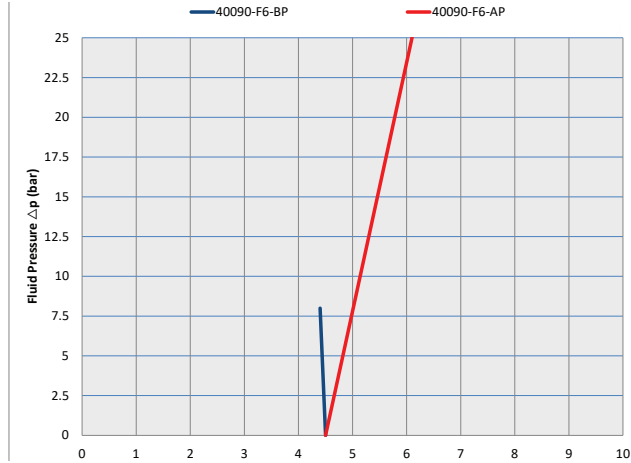

# Coding

## Single Acting Normally Closed F1/F6

### Single Acting Normally Closed F1/F6

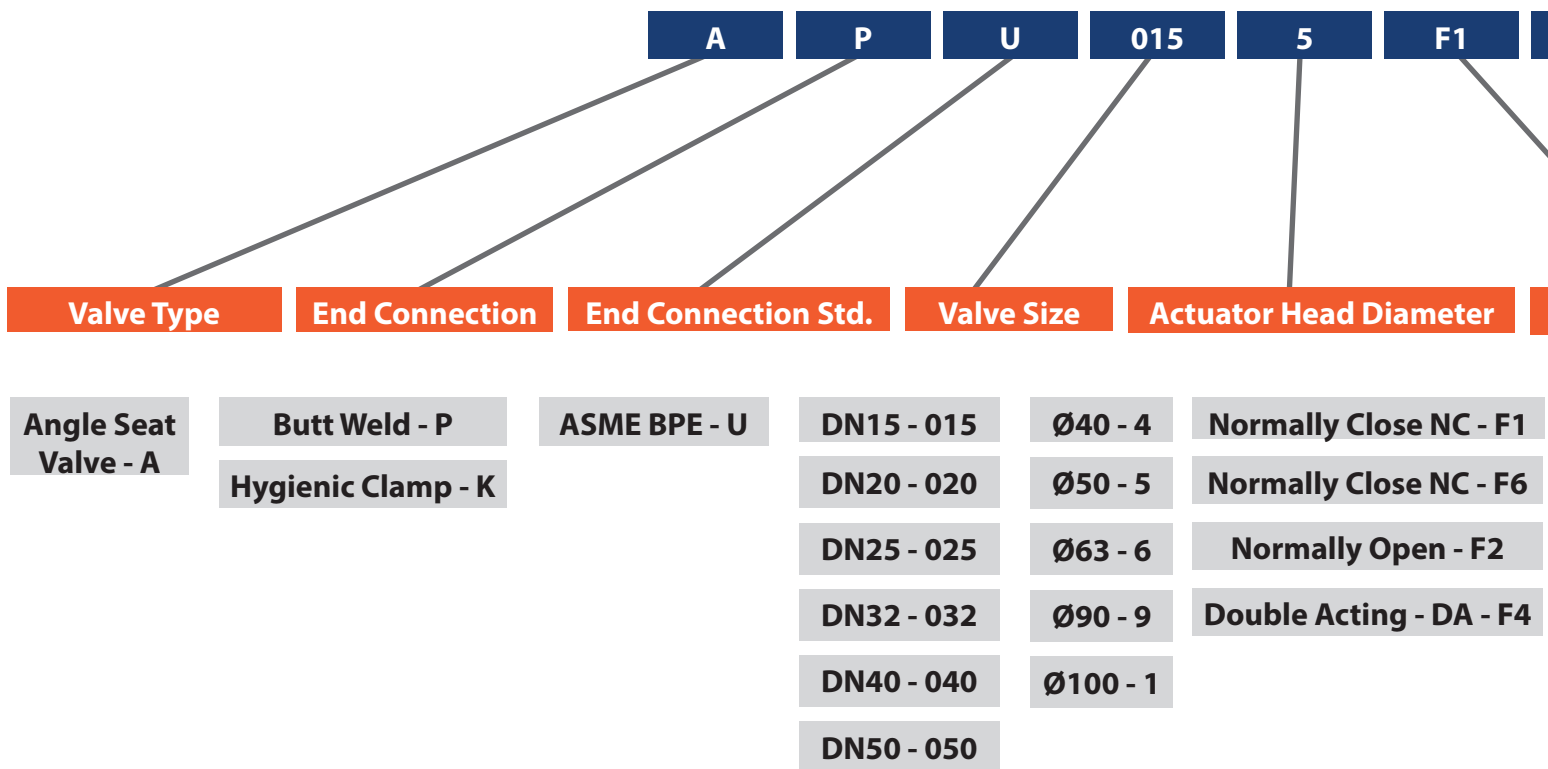



# Coding

## Single Acting Normally Closed F1/F6

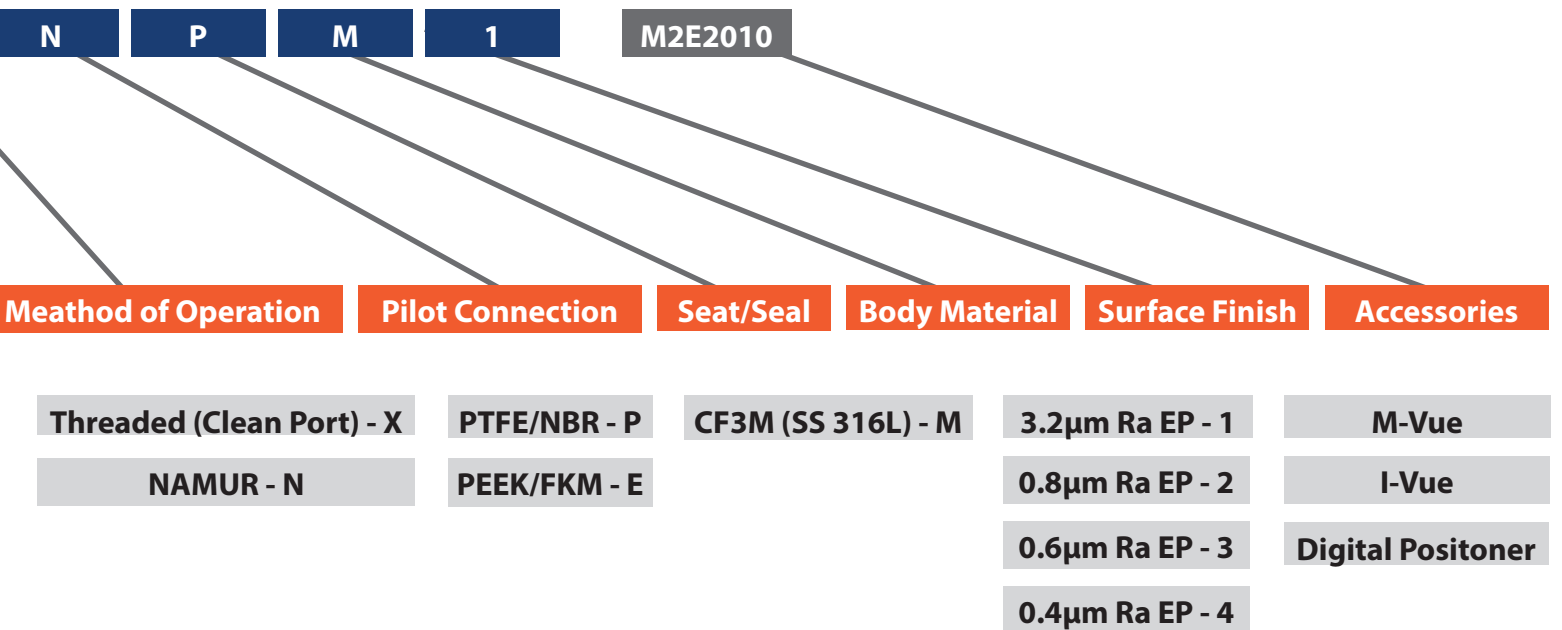

# Standard Combinations

## Single Acting Normally Closed F1/F6

### Normally Closed – Standard Combinations

DN	OPERATOR	INLET
15	Ø50	Bi-Directional
20	Ø50	Bi-Directional
20	Ø50	Bi-Directional
25	Ø50	Bi-Directional
25	Ø63	Bi-Directional
40	Ø63	Bi-Directional
40	Ø63	Bi-Directional
40	Ø90	Bi-Directional
40	Ø90	Bi-Directional
50	Ø63	Above Plug
50	Ø90	Above Plug
50	Ø90	Bi-Directional
50	Ø110	Above Plug
50	Ø110	Bi-Directional

# Operating/Performance Parameters

## Single Acting Normally Open F2 Spring

### Single Acting Normally Open F2 Spring

DN	Actuator Ø	Single acting Normally Open		
		Pressure below plug		
		Pilot Pressure	Fluid Pressure (bar)	
		Up to 10 bar	APU	AKU
15	50	3.4	0	0
		5	10	10
		7.1	25	16
20	50	2	0	0
		5	15	15
		7	25	16
25	50	2	0	0
		5	7.5	7.5
		10	21	12
25	63	2	0	0
		5	13	13
		7.5	25	16
40	63	3	0	0
		5	4.5	4.5
		10	17	10
40	90	2	0	0
		5	13	13
		7.5	25	16
50	90	2	0	0
		5	7	7
		10	20	12
50	110	1.4	0	0
		5	14	14
		7.5	25	16

# Operating/Performance Parameters

## Single Acting Normally Open F2 Spring

### Single Acting Normally Open F2 Spring

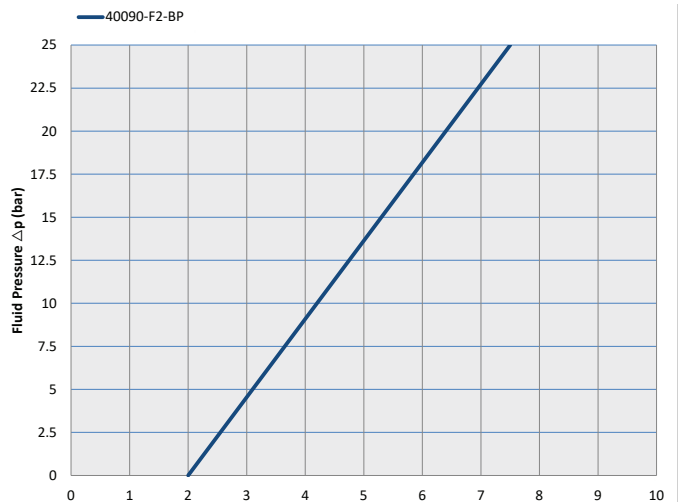
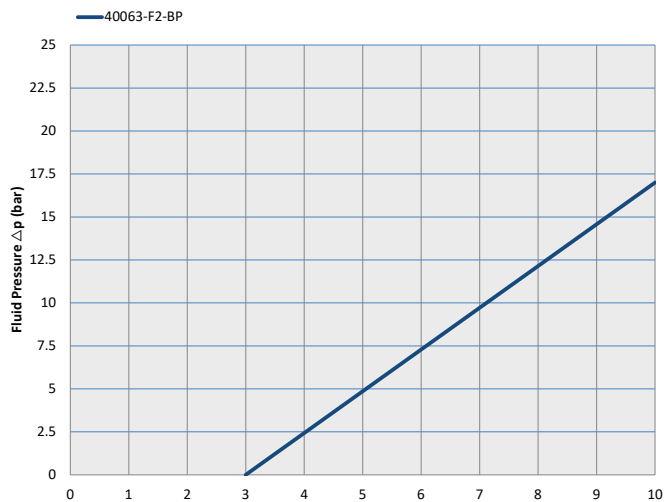
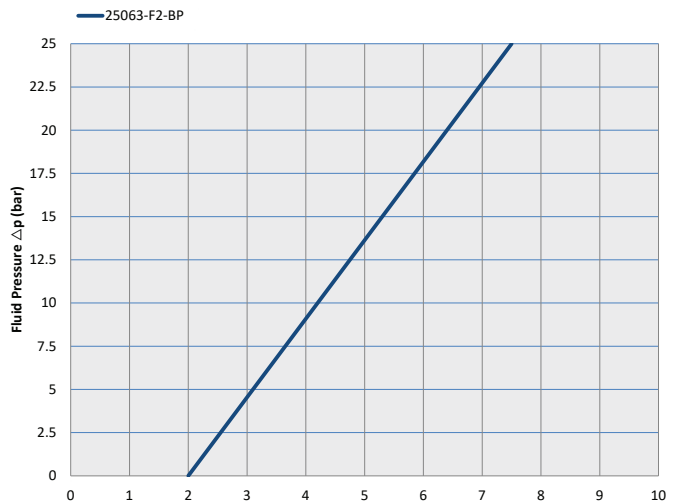
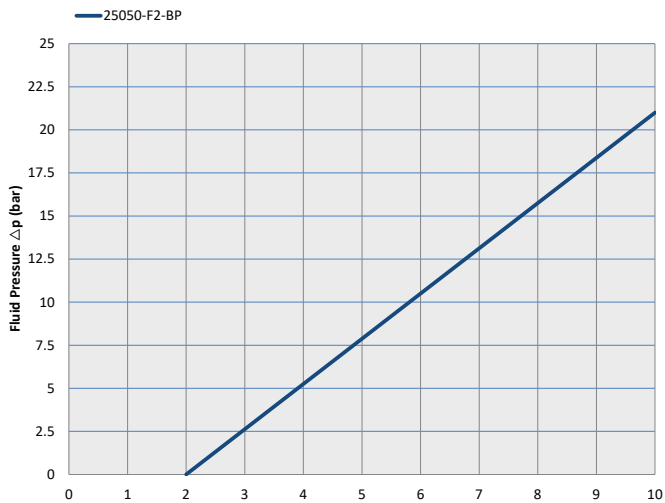
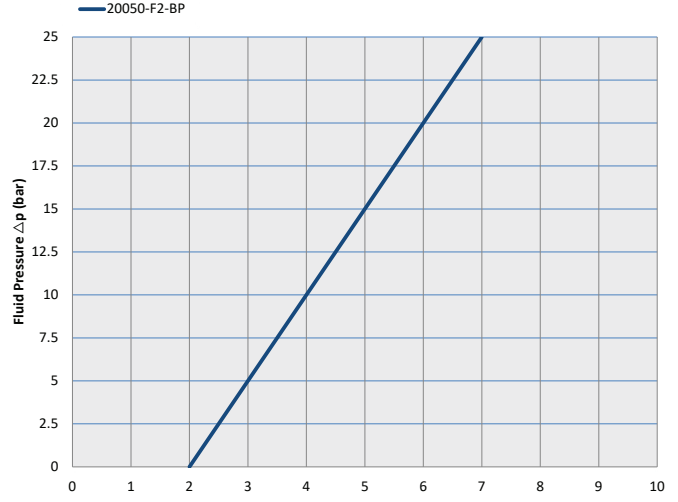
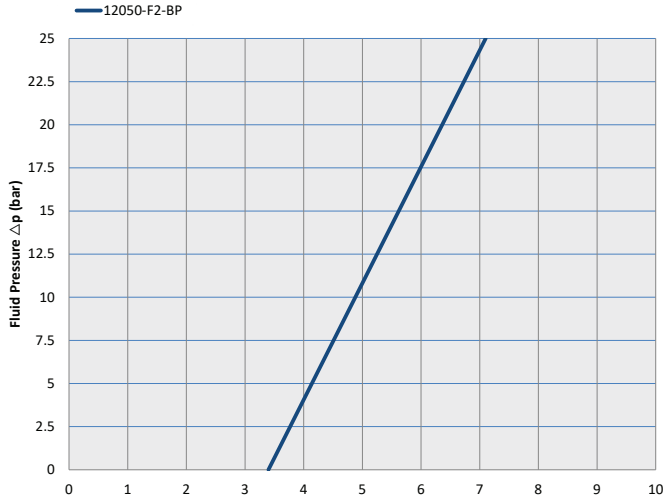

# Operating/Performance Parameters

## Single Acting Normally Open F2 Spring

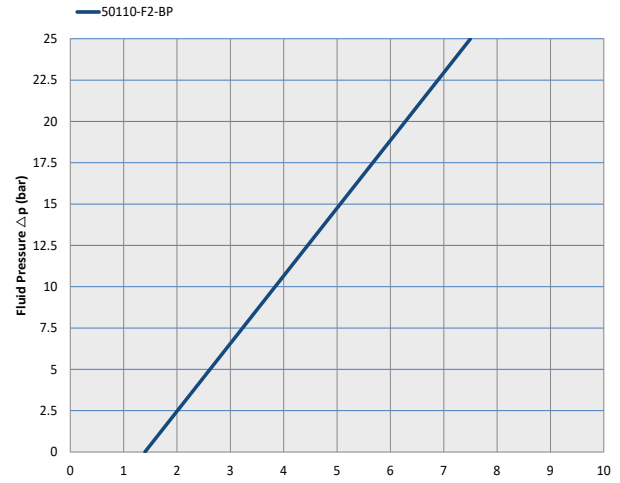
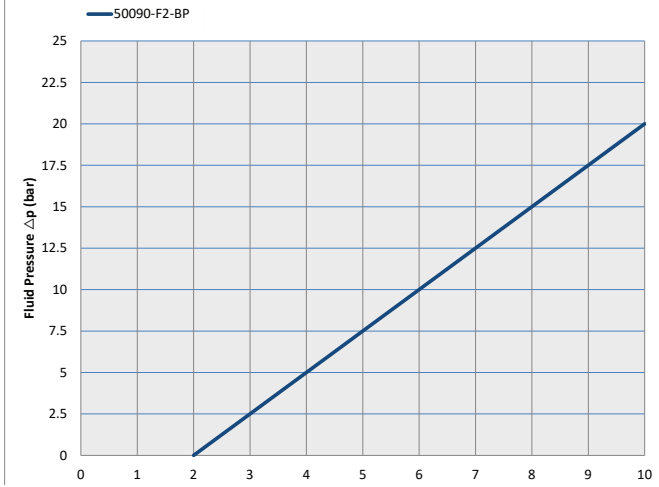

# Operating/Performance Parameters

## Single Acting Normally Open F4 Spring

### Double Acting F4 Spring

DN	Actuator Ø	Double Acting, Bi-Directional					
		Pressure above plug			Pressure below plug		
		Pilot Pressure	Fluid Pressure (bar)		Pilot Pressure	Fluid Pressure (bar)	
		Up to 10 bar	APU	AKU	Up to 10 bar	APU	AKU
15	50	1.2	0	0	1.2	0	0
		2	16	16	3.4	16	16
		2.5	25				
20	50	1.8	0	0	1.8	0	0
		3.2	16	16	4.6	16	16
		4	25				
25	50	1.8	0	0	1.8	0	0
		4.4	16	16	5	11.5	11.5
		5.8	25		6	16	16
40	63	2	0	0	2	0	0
		5	12	12	5	8.5	8.5
		7.9	25	16	6	12	12
40	90	0.8	0	0	0.8	0	0
		3.8	16	16	4.6	16	16
		5.5	25				
50	90	1.4	0	0	1.4	0	0
		5	12.5	12.5	5	10.5	10.5
		8.3	25	16	6.5	16	16
50	110	1.1	0	0	1.1	0	0
		3.8	16	16	4.5	16	16

**Note:** 1. For PED certified valves, maximum fluid pressure is limited to minimum value specified in pressure/temperature chart on page 7 or table above

### Double Acting F4

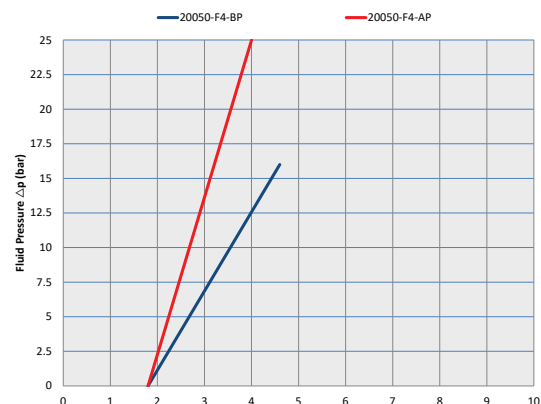
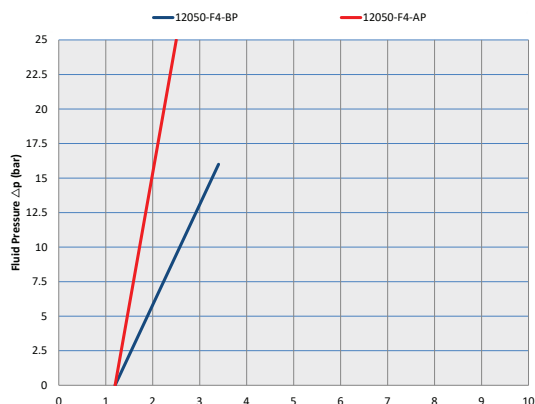

# Operating/Performance Parameters

## Single Acting Normally Open F4 Spring

### Double Acting F4

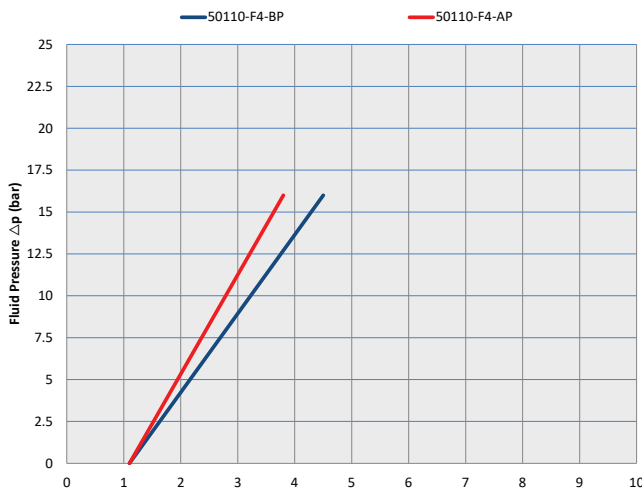
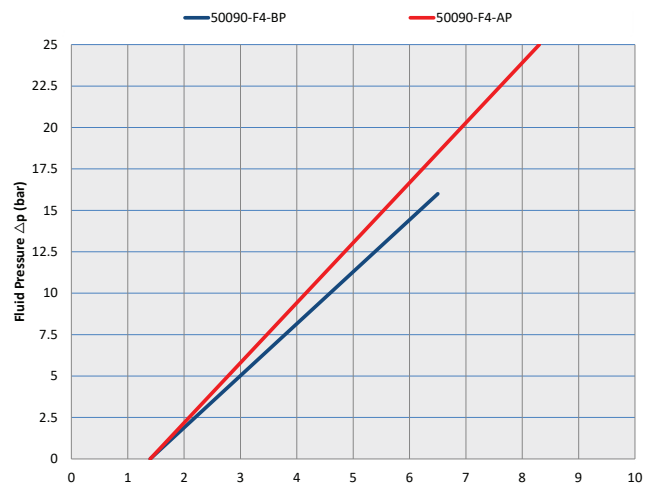
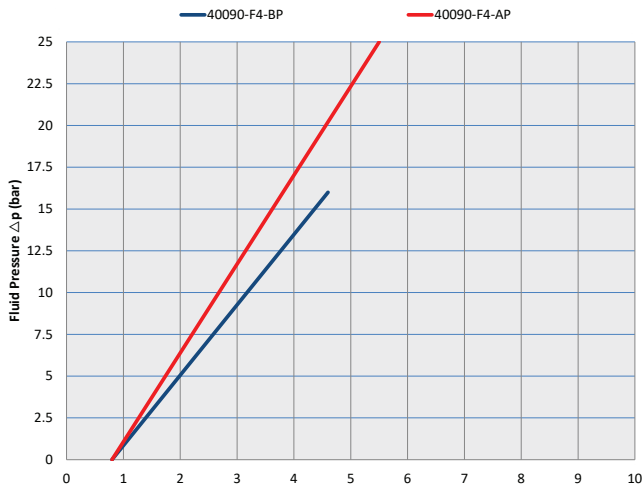
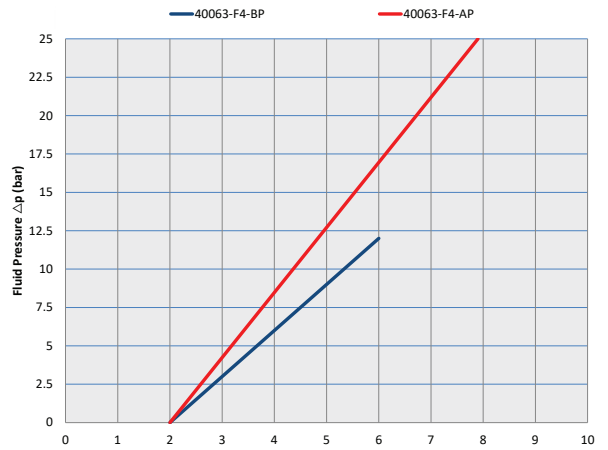
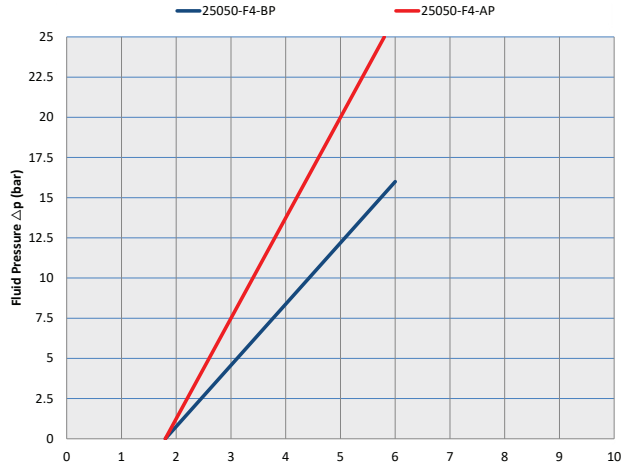

# Product Coding - Accessories

## VUE Sensors

### M-Vue



Accessory Type	Protocol	Solenoid	Electrical Connector	Cable Options
M-Vue - M	Point to Point - 2E2	Not Required - 0	M12 (all protocols) - 1	Refer to page 26
	ASI v 3.0 - A30	PBT 1/8" BSP - 1	Mini 7/8" 5 Pin - 2	
	DeviceNet - DNB	PBT 1/8" NPT - 2		

### I-Vue



Accessory Type	Protocol	Solenoid	Electrical Connector	Cable Options
I-Vue - I	Point to Point - 2E2	Not Required - 0	M12 (all protocols) - 1	Refer to page 27
	ASI v 3.0 - A30	Aluminium (1/8" BSp) - 1	Mini 7/8" 5 Pin - 2	
	DeviceNet - DNB	Aluminium (1/8"NPT) - 3	Cable Gland (1m cable) - 3	
			Flat Cable connector - 4	



## Product Coding - Accessories

### Intelligent Positioners

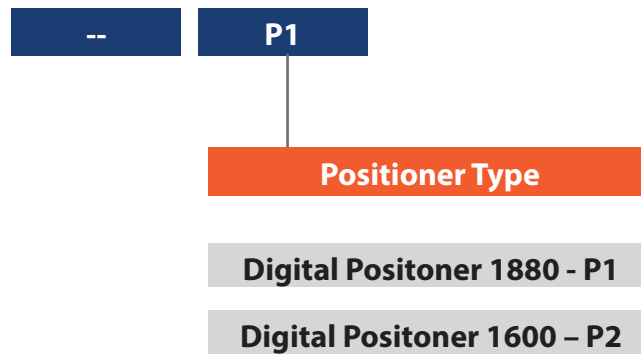



---

**CRANE CHEMPHARMA & ENERGY**

Crane Process Flow Technologies Ltd.  
Grange Road  
Cwmbran, Gwent  
NP44 3XX, United Kingdom  
Tel.: + 44 1633 486666

---

Crane Co., and its subsidiaries cannot accept responsibility for possible errors in catalogues, brochures, other printed materials, and website information. Crane Co. reserves the right to alter its products without notice, including products already on order provided that such alteration can be made without changes being necessary in specifications already agreed. All trademarks in this material are the property of the Crane Co. or its subsidiaries. The Crane and Crane brands logotype (CENTER LINE®, COMPAC-NOZ®, CRANE®, DEPA® & ELRO®, DOPAK®, DUO-CHEK®, FLOWSEAL®, GYROLOK®, GO REGULATOR®, HOKE®, JENKINS®, KROMBACH®, NOZ-CHEK®, PACIFIC VALVES®, RESISTOFLEX®, REVO®, SAUNDERS®, STOCKHAM®, TEXAS SAMPLING®, TRIANGLE®, UNI-CHEK®, VALVES®, WESTLOCK CONTROLS®, WTA®, and XOMOX®) are registered trademarks of Crane Co. All rights reserved.