

Saunders[®]
the science inside

brands you trust.



Bio Block Manual

CRANE[®]

Crane ChemPharma & Energy

www.cranecpe.com



Interactive Web-Based Tools

Saunders[®] has developed interactive web-based tools to facilitate selection of standard and customized valves. This includes our Biotech Process Map which saves time and effort in valve selection in an industry driven by time to market. Our P&ID Table of Orientations provides key design information such as drawings and datasheets for over 100 different valve orientations based on P&ID configuration. Also available is our drawing library which makes 2D pdfs available to all site visitors and 2D dwg and 3D stp files readily available to registered users.

SELECT



**BIO-BLOCK
PROCESS APPLICATIONS**



**BIO-BLOCK PIPING AND
INFORMATION
DRAWINGS (P&ID)**



HC4 DRAWING LIBRARY



Saunders[®] Maintenance Center

DISCOVER



Biotech Process Maps

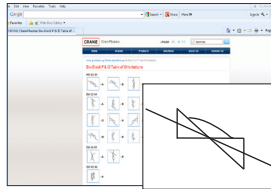

**Various P&ID
Orientations**

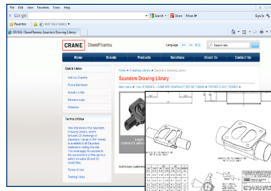

**Download Engineering
Drawings (2D and 3D)**

**SAUNDERS[®]
MAINTENANCE CENTER**

SOLVE



Solutions for Your Applications

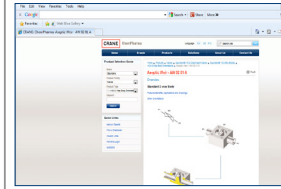

**Solutions For Your
Bio-Block Process**

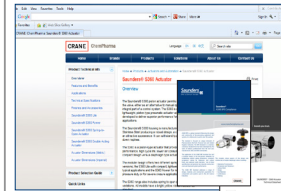

**Download Technical
Datasheets**

**Up-to-date 3D product training
videos and presentations
for the installation and
maintenance of Saunders[®] HC4
valves, switches, and sensors.**





Index

Section 1 Introduction

Section 2 Bio-Block Selection

Section 3 P & ID Overview & Coding Structure

Section 4 AW Aseptic Weir

Section 5 SW Serial Weir

Section 6 MW Multi Weir

Section 7 TW Tank Weir

Section 8 Supplementary HC4 Overview

Introduction

PK Saunders® Invented the Diaphragm Valve Concept

PK Saunders® invented and patented the diaphragm valve concept long before the emergence of the Life Science industry. However, the design features present in the original weir type diaphragm valve remain the reasons the aseptic diaphragm valve is recognized as the valve of choice for aseptic applications.

History of Innovation

Saunders® has led the way in the development of the diaphragm valve to meet ever increasing demands for hygienic performance and regulatory compliance. These innovations have included the introduction of:

- Introduction of forged 316L stainless steel bodies
- First compact pneumatic actuators
- First traceable diaphragms
- First modified PTFE diaphragms
- First controlled sulfur stainless steel bodies
- First compact modular actuators
- First interactive Bio-Block selection guide

Global Compliance

Aseptic Diaphragm Valves are supplied into critical process applications in the world's most closely regulated industries. Full compliance to all relevant Global Standards is an essential element of the product and cannot be taken for granted. Saunders® complies with all applicable Global Standards for diaphragm valves in the Life Science market, including:

- FDA CFR 177.1550 (PTFE), 177.2600 (Elastomer)
- USP Class VI, <87>, <88>
- Traceable to EN 10204 3.1
- 3A Certification
- Animal Derived Component Free (ADCF)
- ASME BPE
- Testing to BS EN 12266-1
- ISO 9001
- CE and PED 97/23/EC
- TUV-Merkblatt HPO Qualification



Aseptic Diaphragm Key Products



Saunders® Standard 2 Ways



Saunders® Welded Tandems and Manifolds



Saunders® Standard Machined Block and Zero Dead Leg



Saunders® HC4 Bio-Blocks



Saunders® Actuation S360 & P345



Saunders® Controls



Saunders® HC4 Diaphragms

Focused Industries



BioPharm



API
(Active Pharmaceutical Ingredients)

CRANE ChemPharma, Saunders® is a global supplier to biotech, Pharmaceutical, and other related markets, including: Food and Beverage • Consumer Products • Paint • Silicon • Biofuel • Fermentation • Cosmetics.



Introduction

Bio-Block Compound Solutions

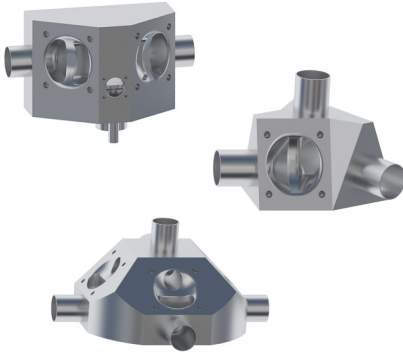

Bio-Block Valves

Bio-Block valves offer the foremost expression of aseptic diaphragm valve technology. Bio-Block designs are machined from solid bar or billet to create tee configurations or clusters of two or more weirs with shared chambers that result in a single design with reduced wetted area, optimum drainability and the highest level of integrity.

Bio-Block Compound Solutions

Almost every process system includes a unique piping challenge that does not lend itself to conventional solutions. Saunders[®] custom designed Bio-Block valves replace welded clusters, manifolds, and valve/fitting combinations and offer the most compact, minimum dead leg design for optimum process integrity.

Saunders[®] Sales and Engineering is pleased to work with you to identify and select the ideal valve design to optimize the performance of your system. Please contact your local distributor or CRANE ChemPharma sales office for support.

Bio-Block Categories Machined From Solid Options

1. Zerostatic Weir: Tee fitting and weir combined
2. Serial Weir: Two weirs sharing a common chamber
3. Multiple Weir: Three or more weirs with a common chamber
4. Tank Weir: Weir integrated into tank bottom
5. Compound Bio-Block: Combination of Bio-Block types into one assembly

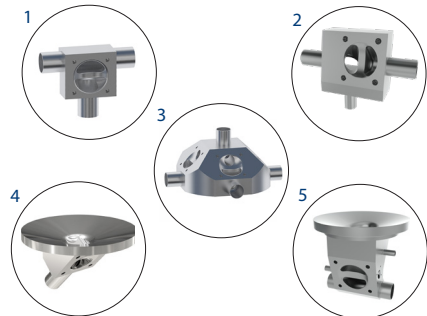

Please visit www.saundersdrawings.com for current library of drawings in PDF, 2D DWG, and 3D STP formats.

Bio-Block Selection

Using the Bio-Block Manual

Refer to P&ID image, sketch or other type of flow diagram:

Look through the P&ID Coding Index. Note that the selections are divided by basic categories into AW - Aseptic Weir, ZW - ZeroDeadleg Weir, SW - Serial Weir, MW - Multiple Weir and TW - Tank Weir

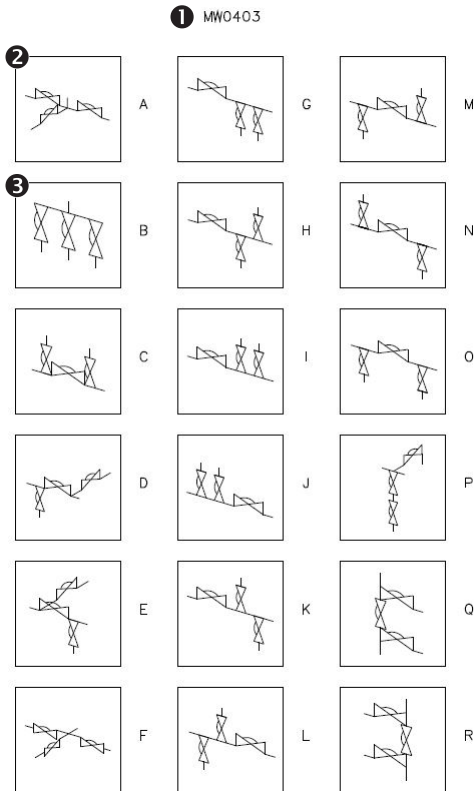

1. Compare flow diagram with examples in the P&ID Coding section of the Bio-Block Manual. It helps to search by basic type and configuration.

2. Each category of Bio-Blocks is organized by number of ports and number of weirs.

3. When a Bio-Block is found that corresponds to the requirement of the flow diagram, note the category, weir port numbers and orientation codes - in this case the category is MW (Multiple Weir), with 4 ports and 3 weirs, in the B orientation. The model number for this Bio-Block is MW0403B.

Bio-Block Selection

Multiple Weir MW0403B ←

Front

Side

Valve	DN Size	
W1		
W2		
W3		
Port	DN Size	Tube Specification
P1		
P2		
P3		
P4		

Installation as shown
H = Horizontal
V = Vertical

4. Go to MW0403B in the Bio-Block Manual and confirm the selection. The example will include P&ID diagram, 3D image and sectioned views.

5. Note that the ports are identified by alpha-numeric codes. Complete Bio-Block data sheet by indicating size of ports and end connections, weir sizes and type of actuators required for each port and weir.

In some designs, port and weir sizes may be different.

The data sheet is complete when surface finish and diaphragm requirements are added.

Saunders application specialists are available to assist in the selection of the optimum Bio-Block design. Please contact your Saunders distributor or local Saunders Sales office.



Bio-Block Selection and Ordering

Is the design in the Bio-Block Programme?

If yes proceed with the following steps, if not refer to the selection guide on the following page.

MW0303

	A
	B
	C
	D
	E
	F

MW0403

	G
	H
	I
	J
	K
	L

Bio-Block product codes are available on the P&ID Coding index and in the individual product sheets in the Bio-Block Manual.

Multiple Weir MW0403B

Front

Side

Valve	DN Size
W1	
W2	
W3	

Port	DN Size	Tube Specification
P1		
P2		
P3		
P4		

Installation as shown
H = Horizontal
V = Vertical

1. Bio-Block Code

2. Line number, Size, End Type, Weir Number and Size and Topworks

Port Number	Line Size	End Type

Weir Number	Weir Size	Diaphragm Type	Topworks

3. Surface Finish _____

4. Material Specification

316L

1.4435

Other - please specify _____





Bio-Block Selection and Ordering

Not every possible Bio-Block solution is listed in the Saunders Bio-Block Manual. Some designs are compound types that combine two or more existing types of configuration into a single Block. Other designs have orientations of weirs and or porting that is not currently catalogued. If you cannot identify the ideal solution to your application, contact your local Saunders distributor or sales office for assistance and to confirm that you are using the current release of the Saunders Bio-Block Manual.

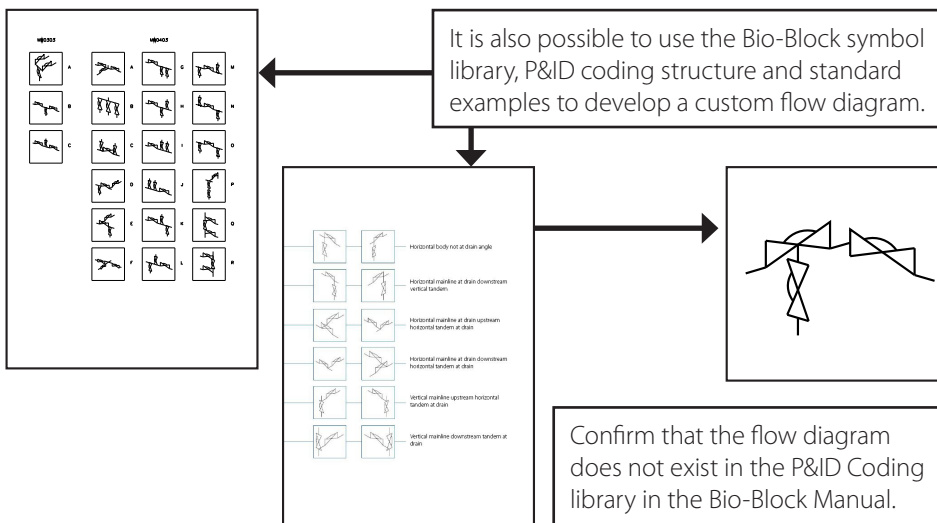

Key design elements must be considered when configuring a Bio-Block.

- Number of ports and weirs
- Piping orientation - vertical, horizontal or mixed
- Weir orientation - vertical, horizontal or mixed
- Which weirs share common chambers
- Do weirs have to fully drain
- Weirs located on the same or opposite side of centerline

Remember that not all proposed Bio-Block solutions can be manufactured. Refer to the Bio-Block preface for design rules and constraints.



P & ID Overview & Coding Structure

AW0201

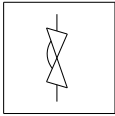

A

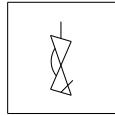

G



B

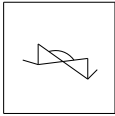

C

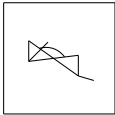

D

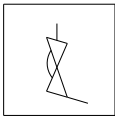

E

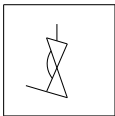

F

AW0301

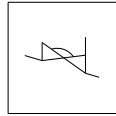

A

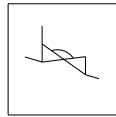

B

AW0401

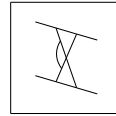

A



P & ID Overview & Coding Structure

ZW0301

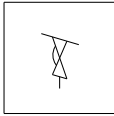

A

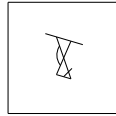

G



B

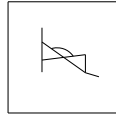

H

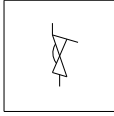

C

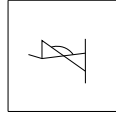

I

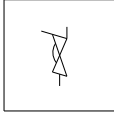

D



E



F

ZW0401

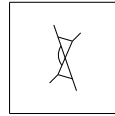

A

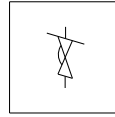

B



P & ID Overview & Coding Structure

SW0202

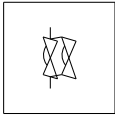

A

SW0302

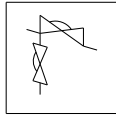

A

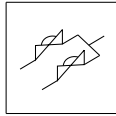

K

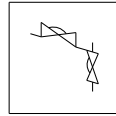

Q

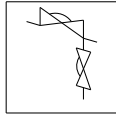

B

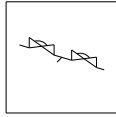

L

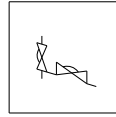

R

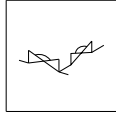

CD

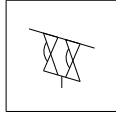

M

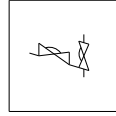

S

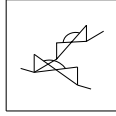

EF

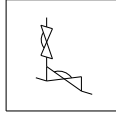

N

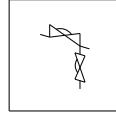

T

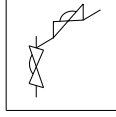

GH

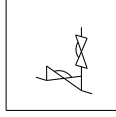

O

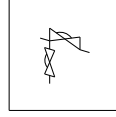

U



IJ



P

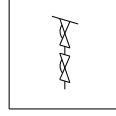

VW



P & ID Overview & Coding Structure

SW0402

SW0502

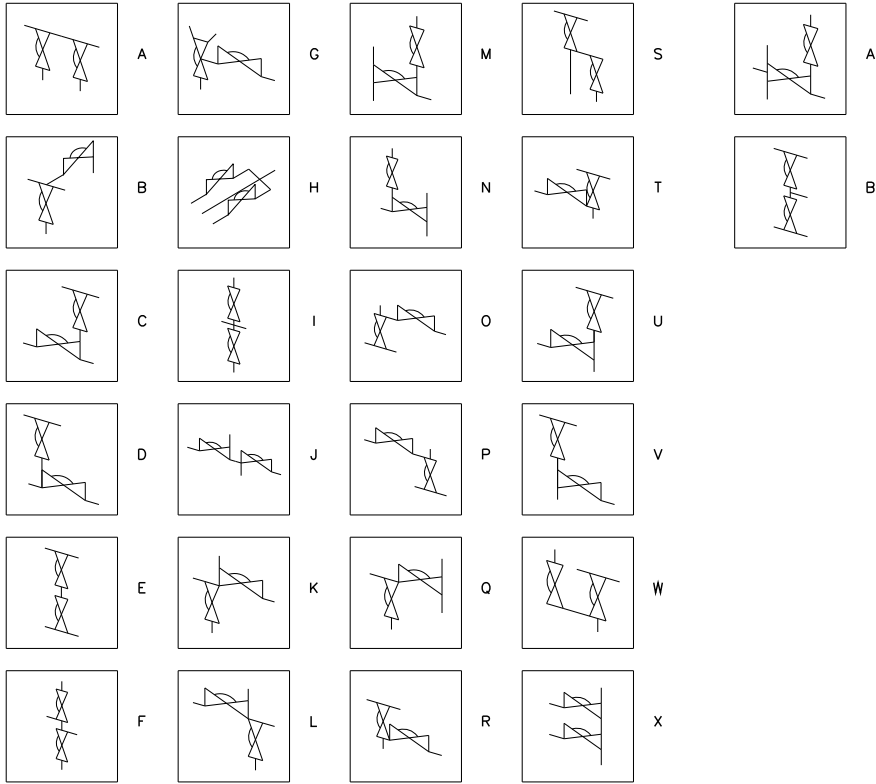



P & ID Overview & Coding Structure

MW0303



A

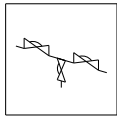

B



C

MW0403

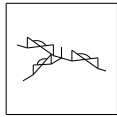

A

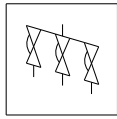

B

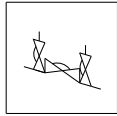

C



D

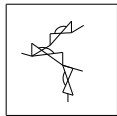

E

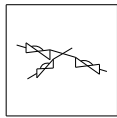

F

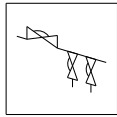

G

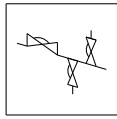

H

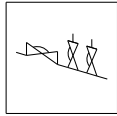

I

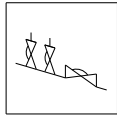

J

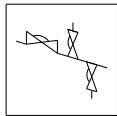

K

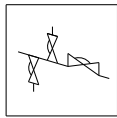

L

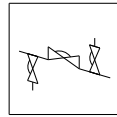

M

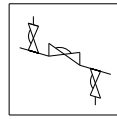

N

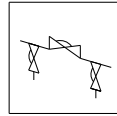

O

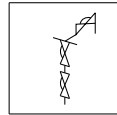

P

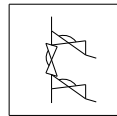

Q

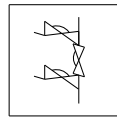

R

P & ID Overview & Coding Structure

MW0503

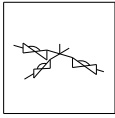

A

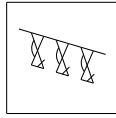

C

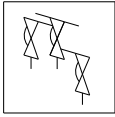

B

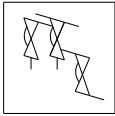

C

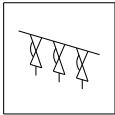

D

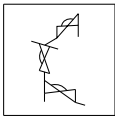

E

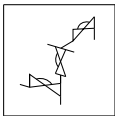

F

MW0404

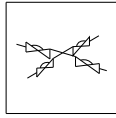

A

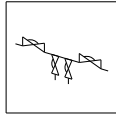

B

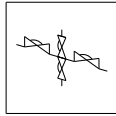

C

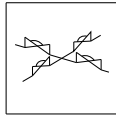

D



P & ID Overview & Coding Structure

MW0405

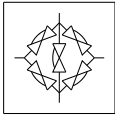

A

MW0406

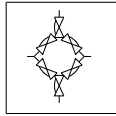

A

MW0504

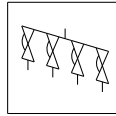

A

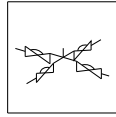

B

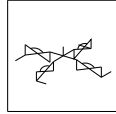

C



P & ID Overview & Coding Structure

MW0604

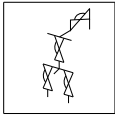

A

MW0605

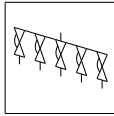

A

MW0705

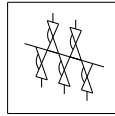

A

MW0706

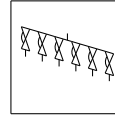

A

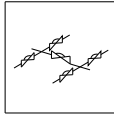

B

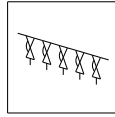

B

MW0908

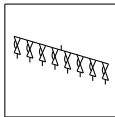

A

MW1008

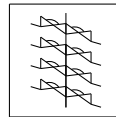

A

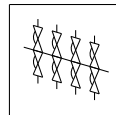

B



P & ID Overview & Coding Structure

TW0201

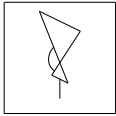

A

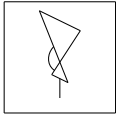

B

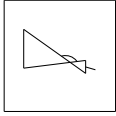

C

TW0301

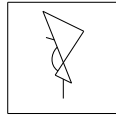

A

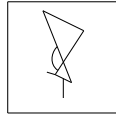

B

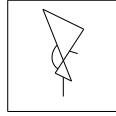

C

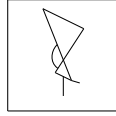

D

TW0302

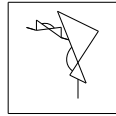

A

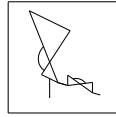

B

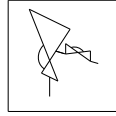

C

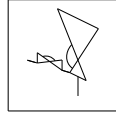

D

TW0504

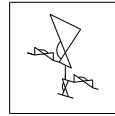

A



Aseptic Weir AW0201A

Front

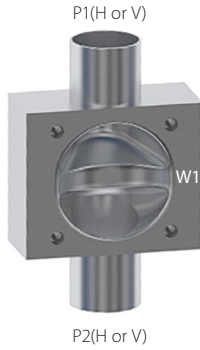

Side

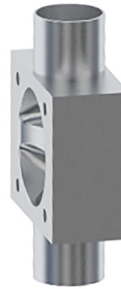

Valve	DN Size	
W1		
Port	DN Size	Tube Specification
P1		
P2		

Installation as shown
H = Horizontal
V = Vertical



Aseptic Weir AW0201B

Front

Side

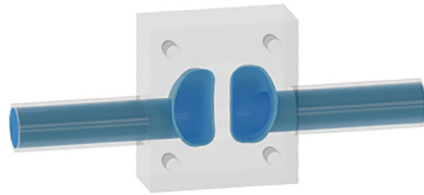
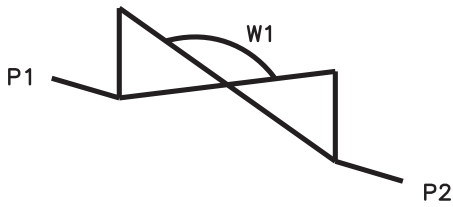

Valve	DN Size	
W1		
Port	DN Size	Tube Specification
P1		
P2		

Installation as shown
H = Horizontal
V = Vertical

Aseptic Weir AW0201C

Front



Side

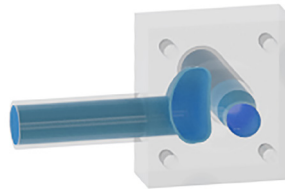
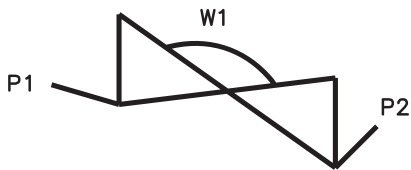
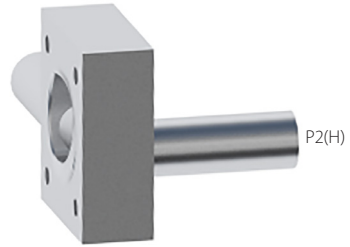

Valve	DN Size	
W1		
Port	DN Size	Tube Specification
P1		
P2		

Installation as shown
H = Horizontal
V = Vertical



Aseptic Weir AW0201D

Front

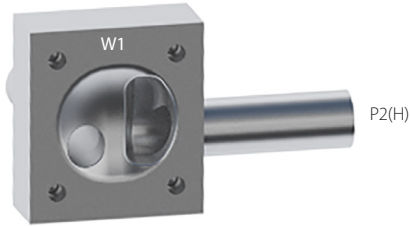

Side

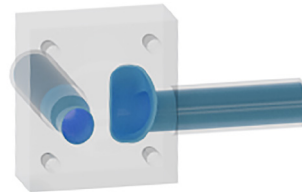
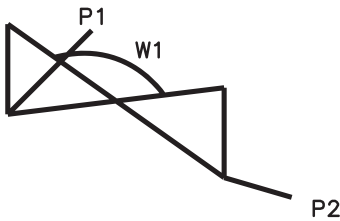
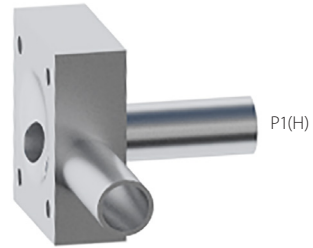

Valve	DN Size	
W1		
Port	DN Size	Tube Specification
P1		
P2		

Installation as shown
H = Horizontal
V = Vertical

Aseptic Weir AW0201E

Front

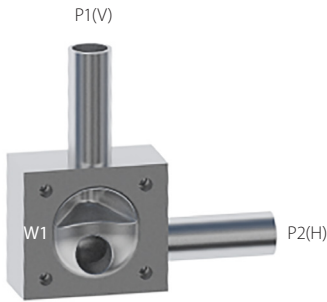

Side

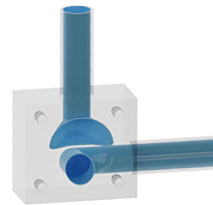
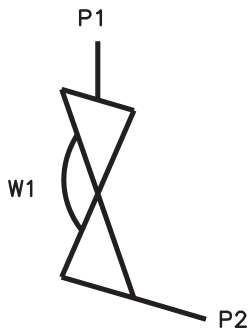
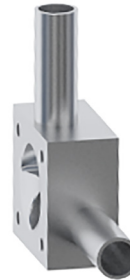

Valve	DN Size	
W1		
Port	DN Size	Tube Specification
P1		
P2		

Installation as shown
H = Horizontal
V = Vertical



Aseptic Weir AW0201F

Front

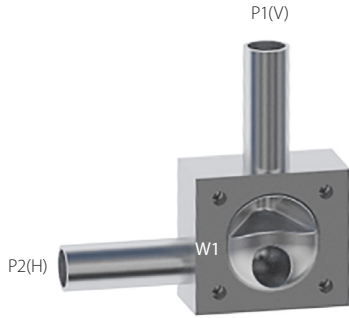

Side

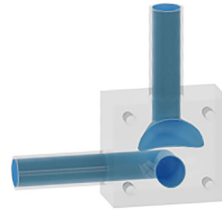
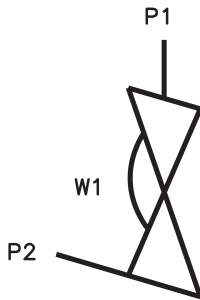

Valve	DN Size	
W1		
Port	DN Size	Tube Specification
P1		
P2		

Installation as shown
H = Horizontal
V = Vertical



Aseptic Weir AW0201G

Front



Side

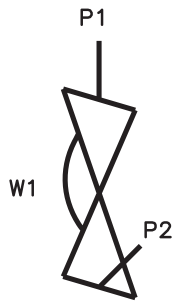
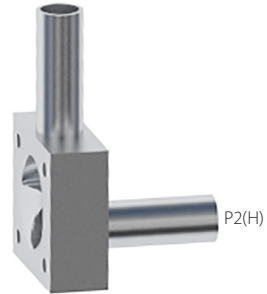

Valve	DN Size	
W1		
Port	DN Size	Tube Specification
P1		
P2		

Installation as shown
H = Horizontal
V = Vertical





Aseptic Weir AW0301A

Front

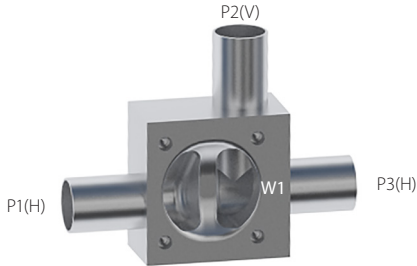

Side

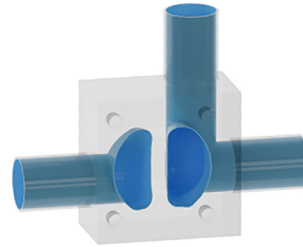
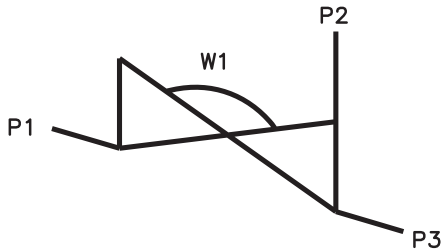

Valve	DN Size	
W1		
Port	DN Size	Tube Specification
P1		
P2		
P3		

Installation as shown
H = Horizontal
V = Vertical



Aseptic Weir AW0301B

Front

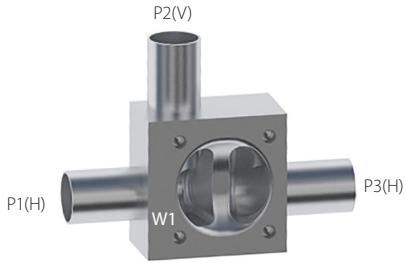

Side

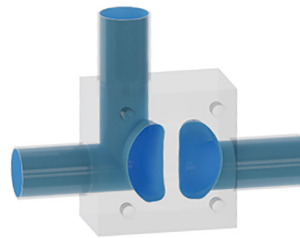
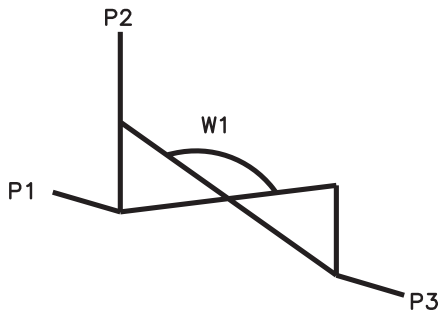
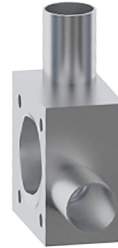

Valve	DN Size	
W1		
Port	DN Size	Tube Specification
P1		
P2		
P3		

Installation as shown
H = Horizontal
V = Vertical



Aseptic Weir AW0401A

Front

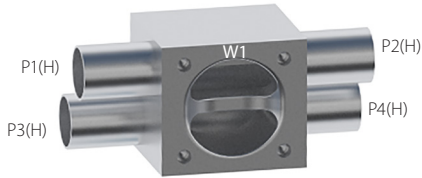

Side

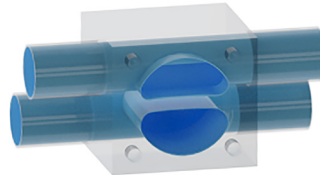
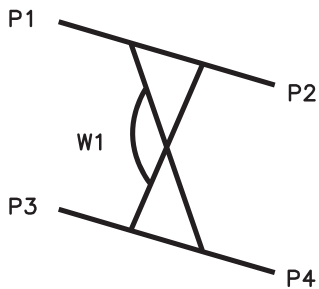
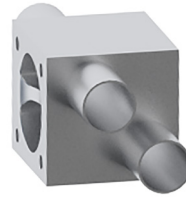

Valve	DN Size	
W1		
Port	DN Size	Tube Specification
P1		
P2		
P3		
P4		

Installation as shown
H = Horizontal
V = Vertical



Zero Static Weir ZW0301A

Front



Side

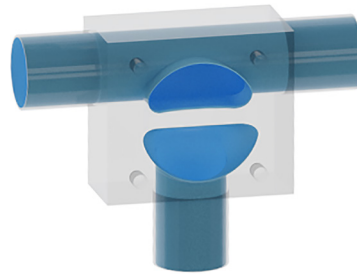
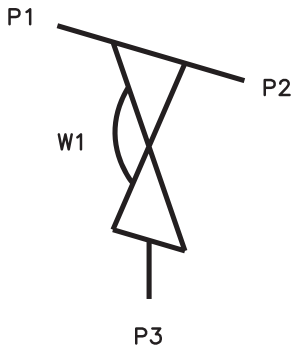

Valve	DN Size	
W1		
Port	DN Size	Tube Specification
P1		
P2		
P3		

Installation as shown
H = Horizontal
V = Vertical



Zero Static Weir ZW0301B

Front



Side

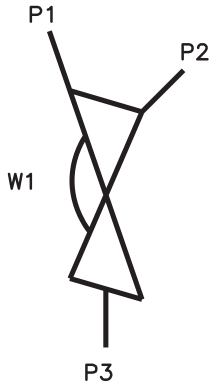

Valve	DN Size	
W1		
Port	DN Size	Tube Specification
P1		
P2		
P3		

Installation as shown
H = Horizontal
V = Vertical



Zero Static Weir ZW0301C

Front



Side

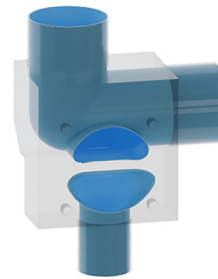
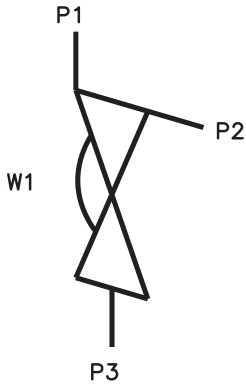
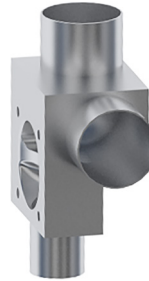

Valve	DN Size	
W1		
Port	DN Size	Tube Specification
P1		
P2		
P3		

Installation as shown
H = Horizontal
V = Vertical



Zero Static Weir ZW0301D

Front

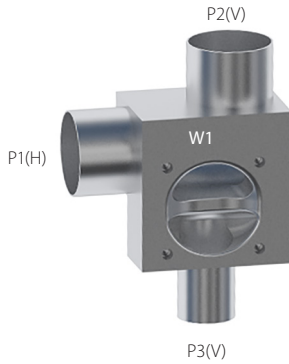

Side

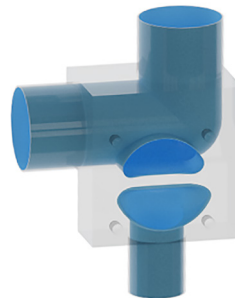
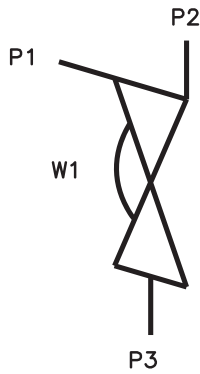

Valve	DN Size	
W1		
Port	DN Size	Tube Specification
P1		
P2		
P3		

Installation as shown
H = Horizontal
V = Vertical

Zero Static Weir ZW0301E

Front

Side

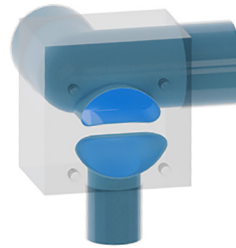
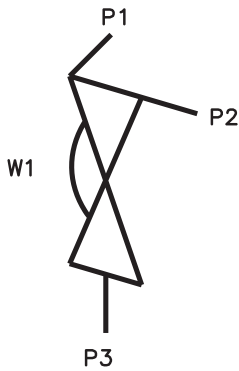
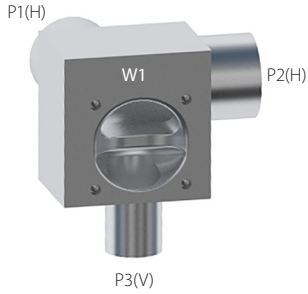

Valve	DN Size	
W1		
Port	DN Size	Tube Specification
P1		
P2		
P3		

Installation as shown
H = Horizontal
V = Vertical



Zero Static Weir ZW0301F

Front

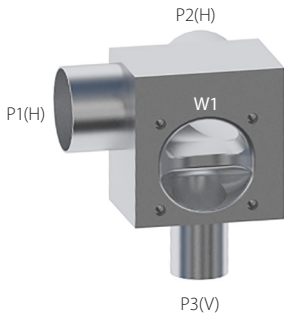

Side

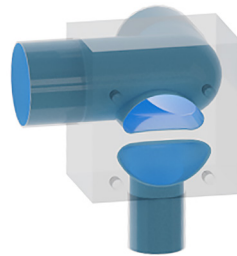
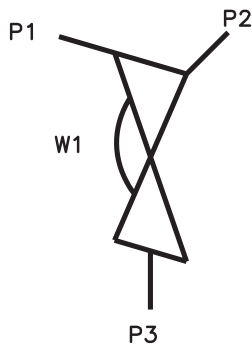

Valve	DN Size	
W1		
Port	DN Size	Tube Specification
P1		
P2		
P3		

Installation as shown
H = Horizontal
V = Vertical

Zero Static Weir ZW0301G

Front

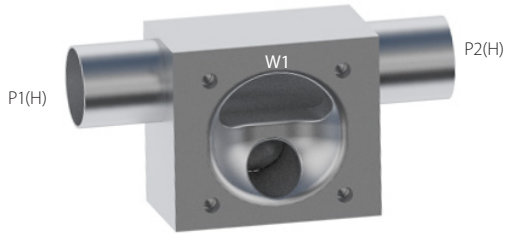

Side

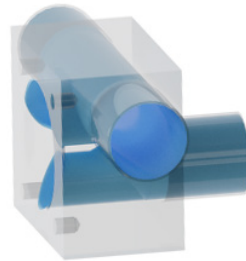
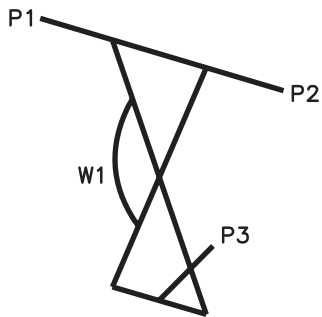
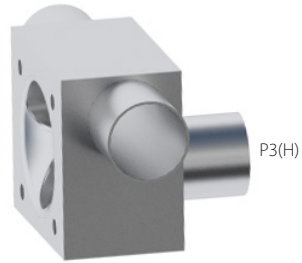

Valve	DN Size	
W1		
Port	DN Size	Tube Specification
P1		
P2		
P3		

Installation as shown
H = Horizontal
V = Vertical



Zero Static Weir ZW0301H

Front

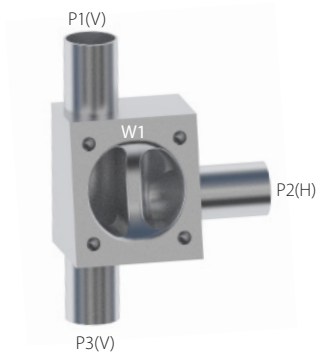

Side

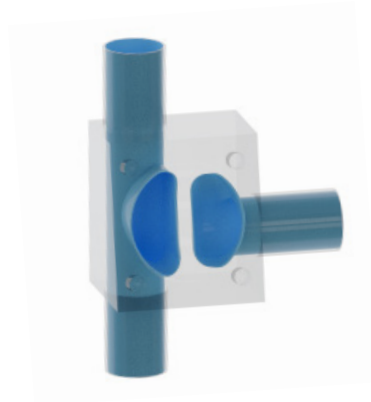
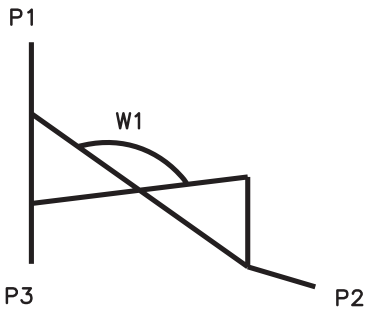
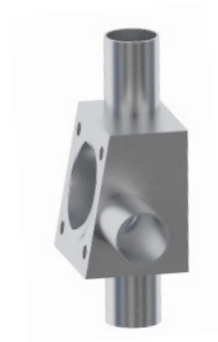

Valve	DN Size	
W1		
Port	DN Size	Tube Specification
P1		
P2		
P3		

Installation as shown
H = Horizontal
V = Vertical



Zero Static Weir ZW0301I

Front

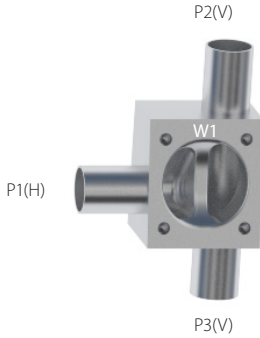

Side

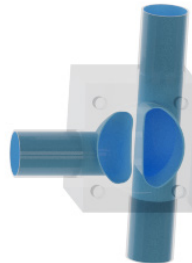
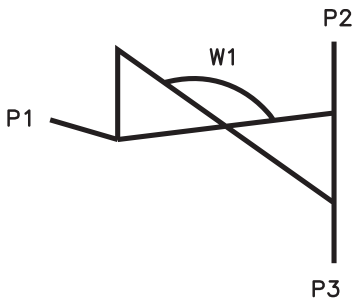
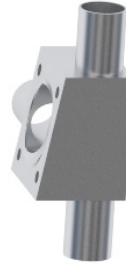

Valve	DN Size	
W1		
Port	DN Size	Tube Specification
P1		
P2		
P3		

Installation as shown
H = Horizontal
V = Vertical



Zero Static Weir ZW0401A

Front

Side

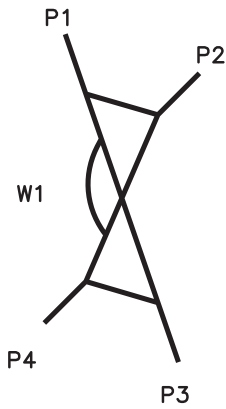
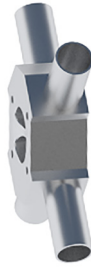
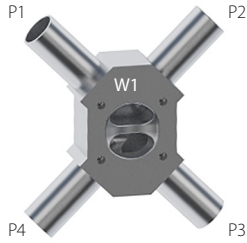

Valve	DN Size	
W1		
Port	DN Size	Tube Specification
P1		
P2		
P3		
P4		

Installation as shown
H = Horizontal
V = Vertical



Zero Static Weir ZW0401B

Front

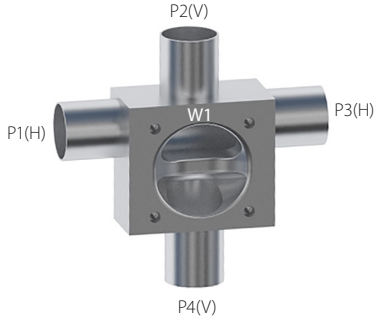

Side

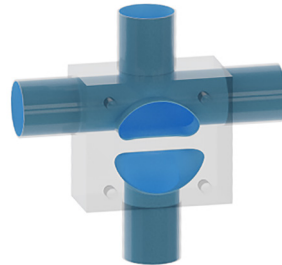
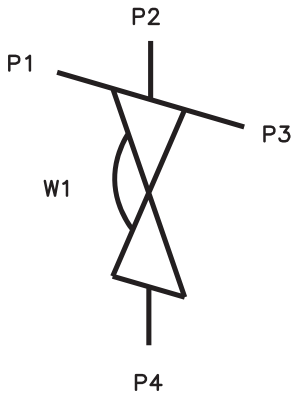

Valve	DN Size	
W1		
Port	DN Size	Tube Specification
P1		
P2		
P3		
P4		

Installation as shown
H = Horizontal
V = Vertical



Serial Weir SW0202A

Front



Back

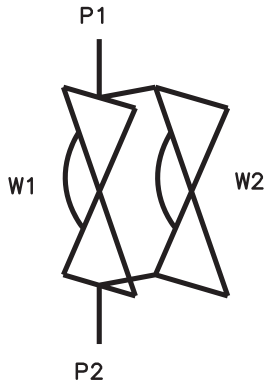
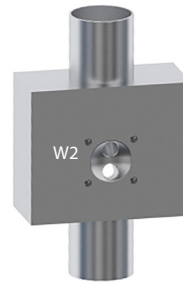

Valve	DN Size	
W1		
W2		
Port	DN Size	Tube Specification
P1		
P2		

Installation as shown
H = Horizontal
V = Vertical



Serial Weir SW0302A

Front

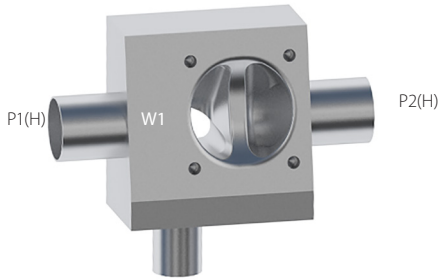

Back

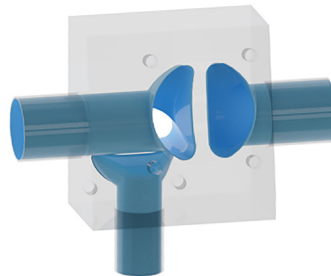
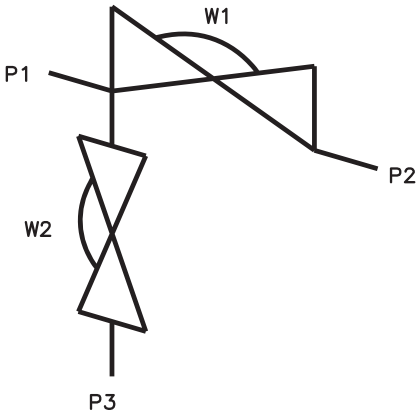

Valve	DN Size	
W1		
W2		
Port	DN Size	Tube Specification
P1		
P2		
P3		

Installation as shown
H = Horizontal
V = Vertical





Serial Weir SW0302B

Front

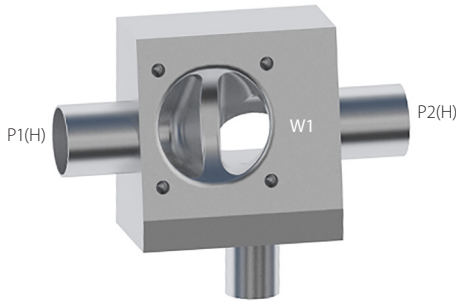

Back

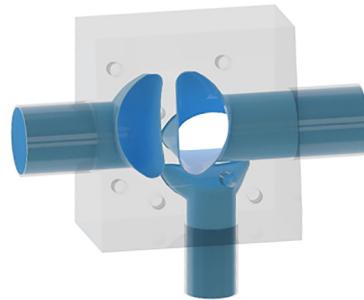
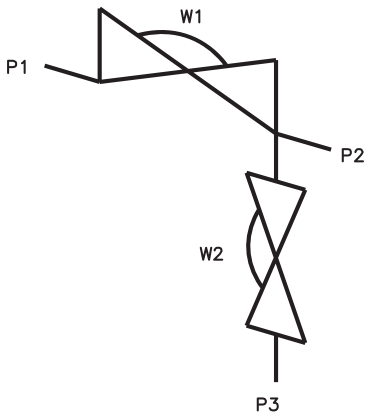

Valve	DN Size	
W1		
W2		
Port	DN Size	Tube Specification
P1		
P2		
P3		

Installation as shown
H = Horizontal
V = Vertical



Serial Weir SW0302C

Front

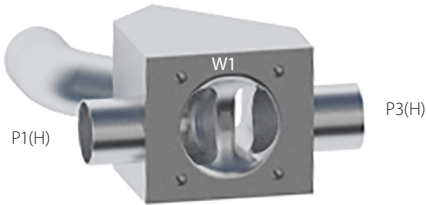

Back

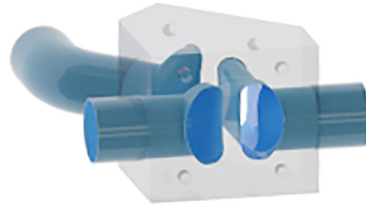
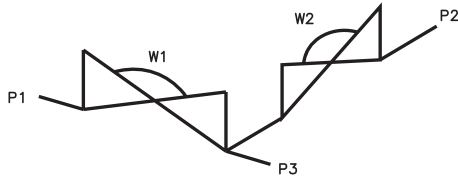

Valve	DN Size	
W1		
W2		
Port	DN Size	Tube Specification
P1		
P2		
P3		

Installation as shown
H = Horizontal
V = Vertical



Serial Weir SW0302D

Front

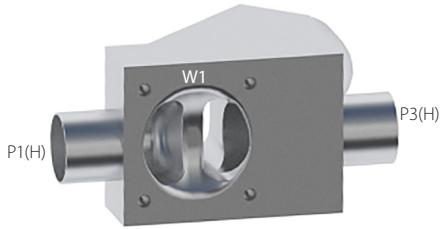

Side

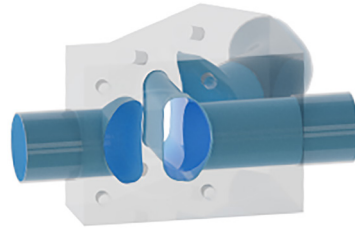
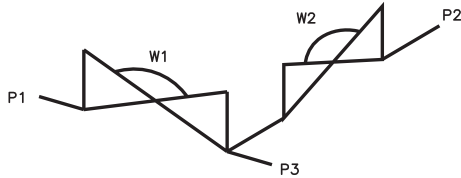

Valve	DN Size	
W1		
W2		
Port	DN Size	Tube Specification
P1		
P2		
P3		

Installation as shown
H = Horizontal
V = Vertical



Serial Weir SW0302E

Front



Side

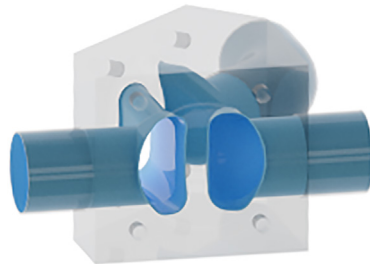
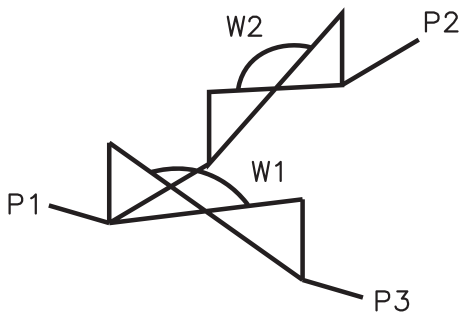
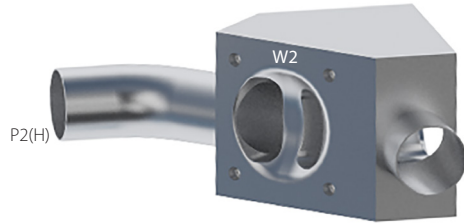

Valve	DN Size	
W1		
W2		
Port	DN Size	Tube Specification
P1		
P2		
P3		

Installation as shown
H = Horizontal
V = Vertical



Serial Weir SW0302F

Front



Side

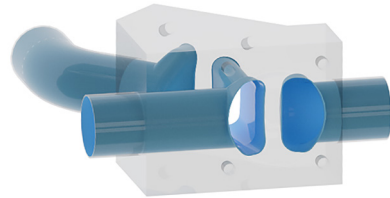
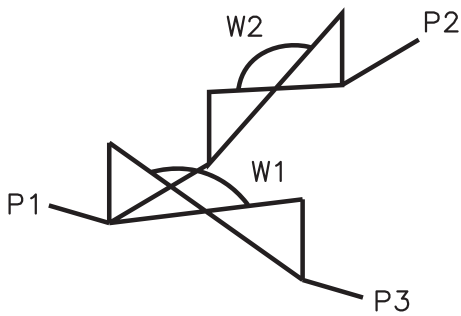
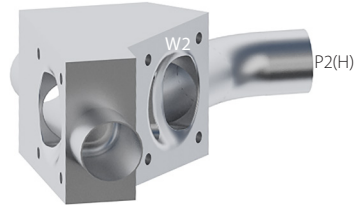

Valve	DN Size	
W1		
W2		
Port	DN Size	Tube Specification
P1		
P2		
P3		

Installation as shown
H = Horizontal
V = Vertical



Serial Weir SW0302G

Front

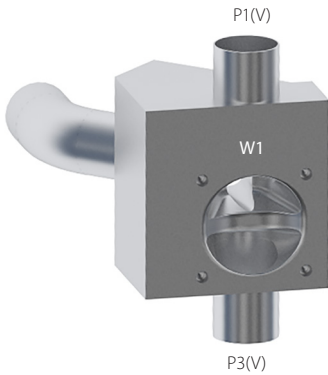

Side

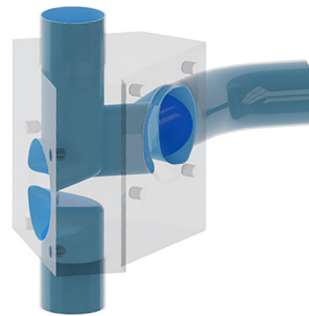
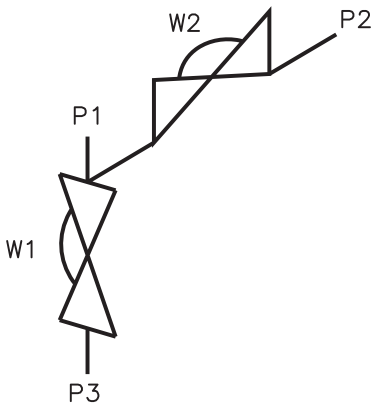
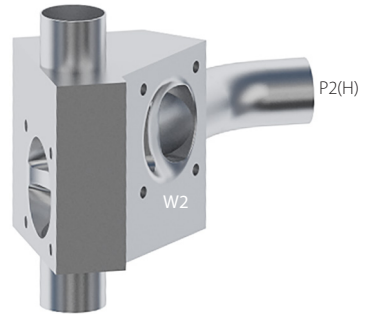

Valve	DN Size	
W1		
W2		
Port	DN Size	Tube Specification
P1		
P2		
P3		

Installation as shown
H = Horizontal
V = Vertical



Serial Weir SW0302H

Front



Side

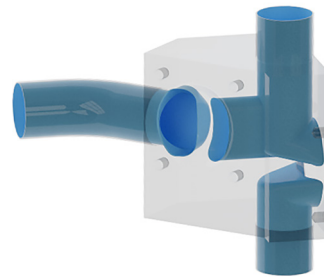
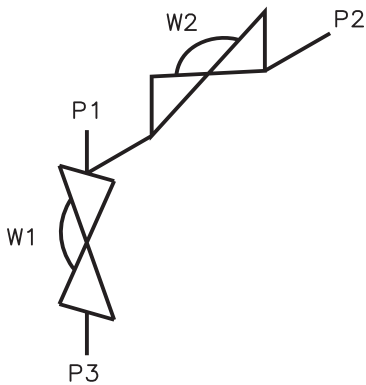
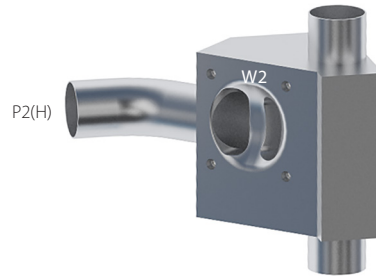

Valve	DN Size	
W1		
W2		
Port	DN Size	Tube Specification
P1		
P2		
P3		

Installation as shown
H = Horizontal
V = Vertical



Serial Weir SW0302I

Front

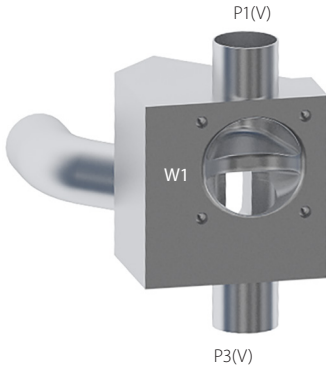

Side

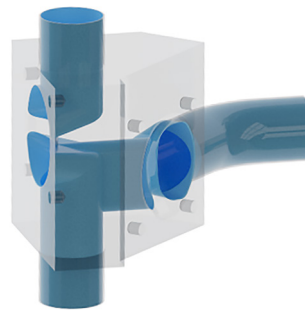
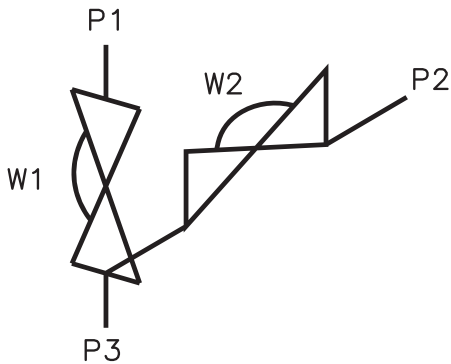
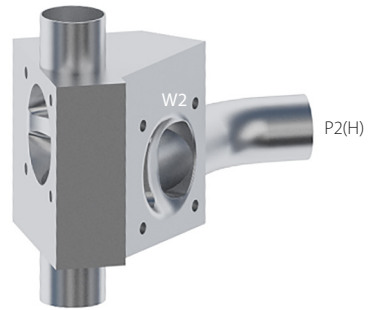

Valve	DN Size	
W1		
W2		
Port	DN Size	Tube Specification
P1		
P2		
P3		

Installation as shown
H = Horizontal
V = Vertical



Serial Weir SW0302J

Front



Side

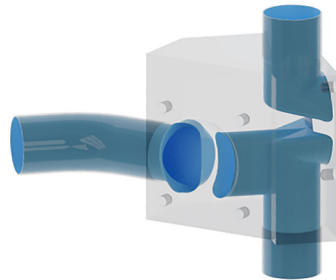
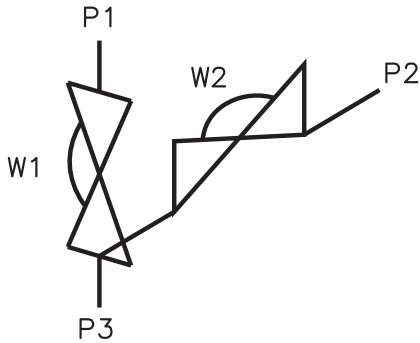
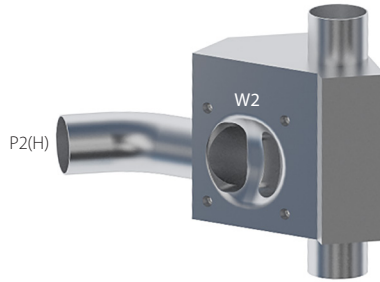

Valve	DN Size	
W1		
W2		
Port	DN Size	Tube Specification
P1		
P2		
P3		

Installation as shown
H = Horizontal
V = Vertical



Serial Weir SW0302K

Front

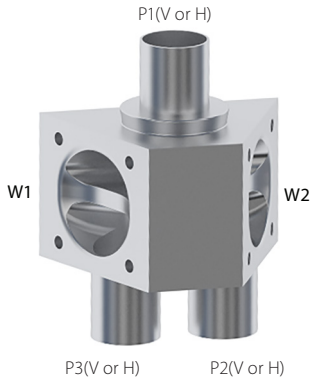

Side

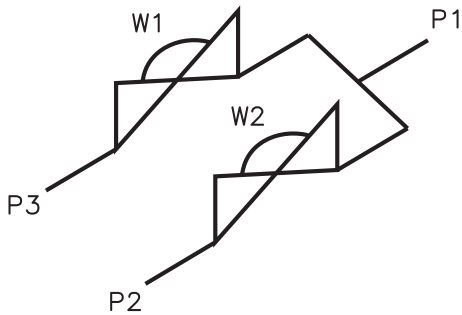
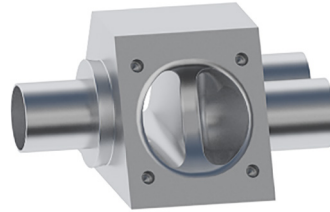

Valve	DN Size	
W1		
W2		
Port	DN Size	Tube Specification
P1		
P2		
P3		

Installation as shown
H = Horizontal
V = Vertical



Serial Weir SW0302L

Front

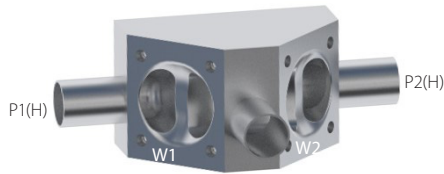

Side

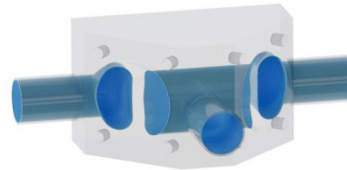
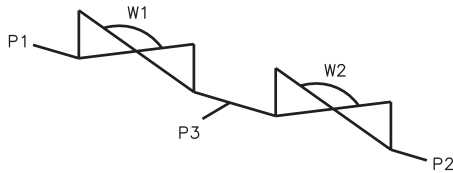
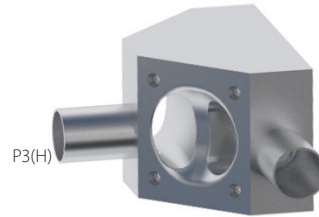

Valve	DN Size	
W1		
W2		
Port	DN Size	Tube Specification
P1		
P2		
P3		

Installation as shown
H = Horizontal
V = Vertical



Serial Weir SW0302M

Front

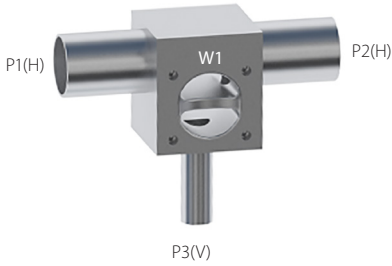

Back

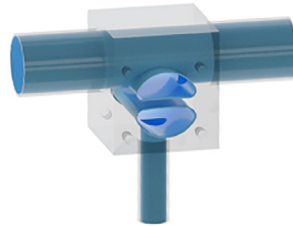
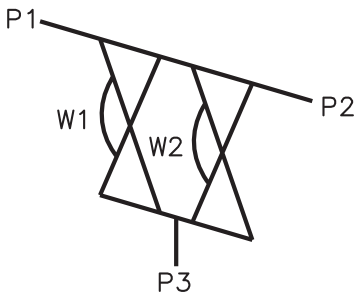

Valve	DN Size	
W1		
W2		
Port	DN Size	Tube Specification
P1		
P2		
P3		

Installation as shown
H = Horizontal
V = Vertical



Serial Weir SW0302N

Front



Back

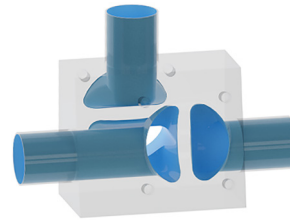
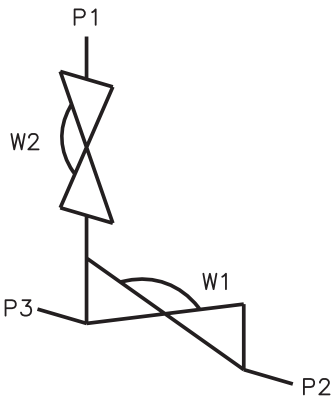
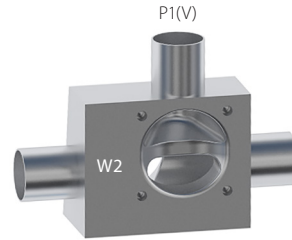

Valve	DN Size	
W1		
W2		
Port	DN Size	Tube Specification
P1		
P2		
P3		

Installation as shown
H = Horizontal
V = Vertical



Serial Weir SW03020

Front



Back

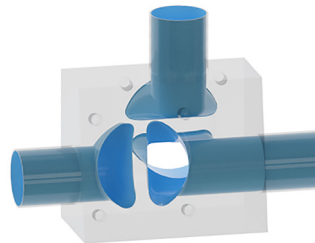
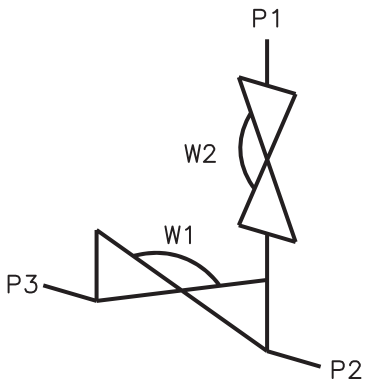
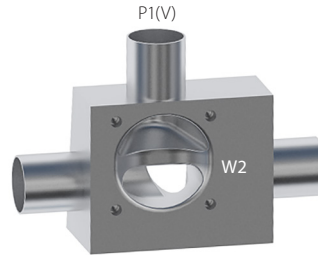

Valve	DN Size	
W1		
W2		
Port	DN Size	Tube Specification
P1		
P2		
P3		

Installation as shown
H = Horizontal
V = Vertical



Serial Weir SW0302P

Front



Back

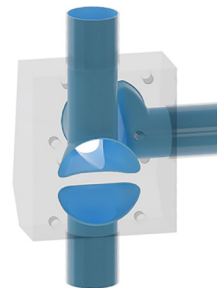
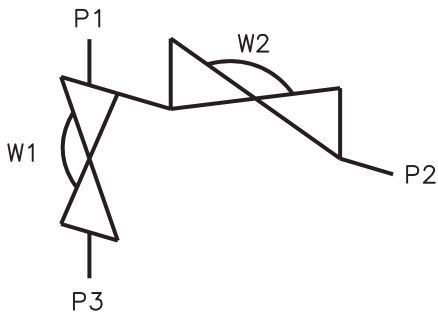
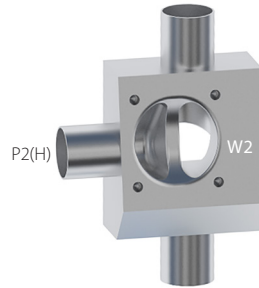

Valve	DN Size	
W1		
W2		
Port	DN Size	Tube Specification
P1		
P2		
P3		

Installation as shown
H = Horizontal
V = Vertical



Serial Weir SW0302Q

Front



Back

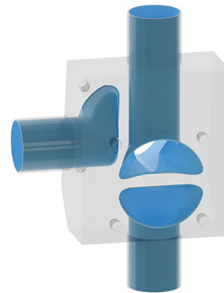
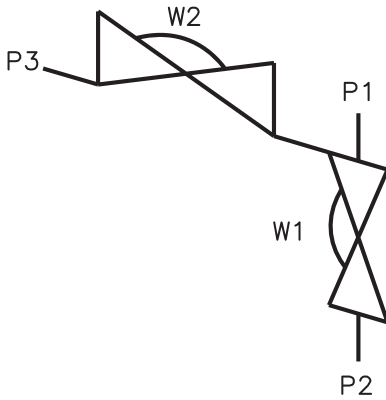
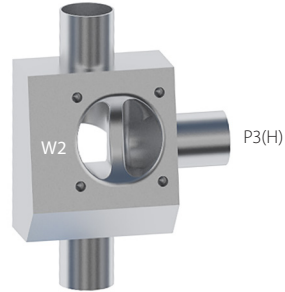

Valve	DN Size	
W1		
W2		
Port	DN Size	Tube Specification
P1		
P2		
P3		

Installation as shown
H = Horizontal
V = Vertical



Serial Weir SW0302R

Front



Back

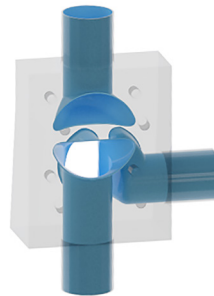
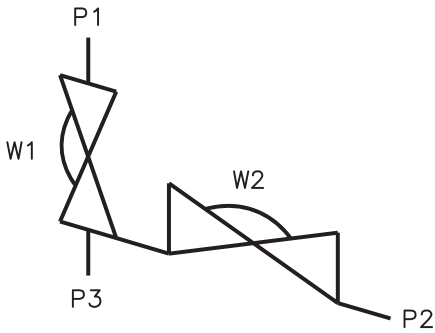
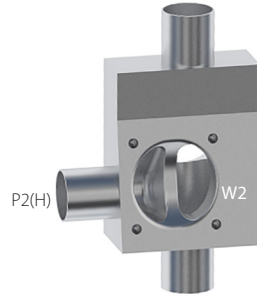

Valve	DN Size	
W1		
W2		
Port	DN Size	Tube Specification
P1		
P2		
P3		

Installation as shown
H = Horizontal
V = Vertical



Serial Weir SW0302S

Front

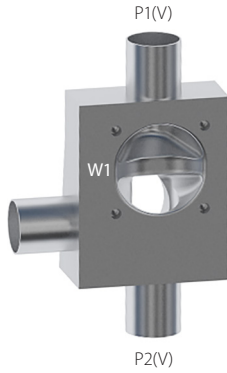

Back

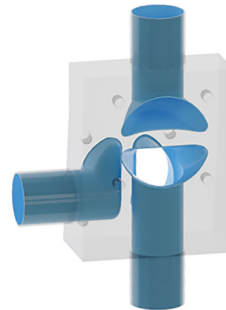
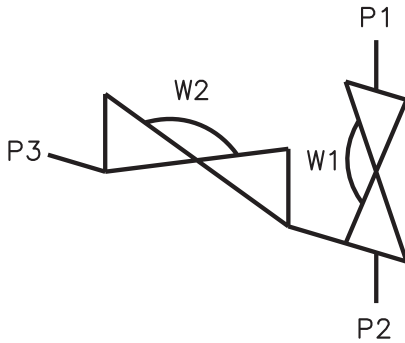
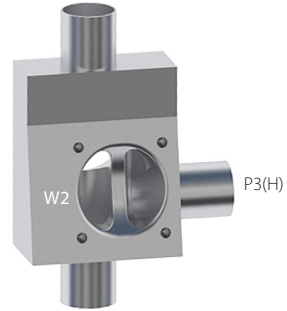

Valve	DN Size	
W1		
W2		
Port	DN Size	Tube Specification
P1		
P2		
P3		

Installation as shown
H = Horizontal
V = Vertical



Serial Weir SW0302T

Front

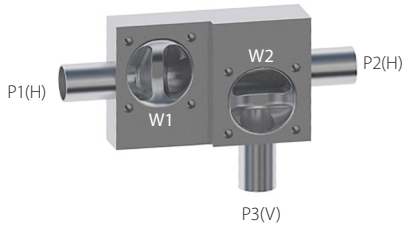

Side

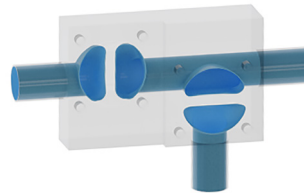
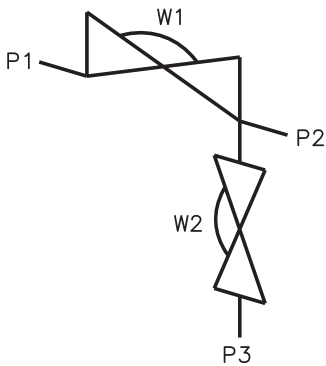

Valve	DN Size	
W1		
W2		
Port	DN Size	Tube Specification
P1		
P2		
P3		

Installation as shown
H = Horizontal
V = Vertical

Serial Weir SW0302U

Front

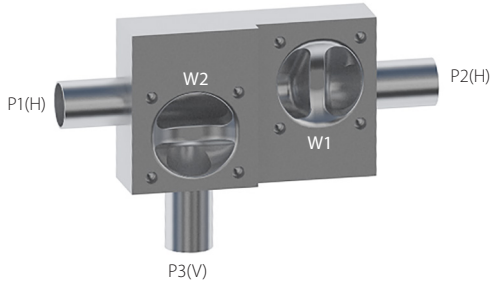

Side

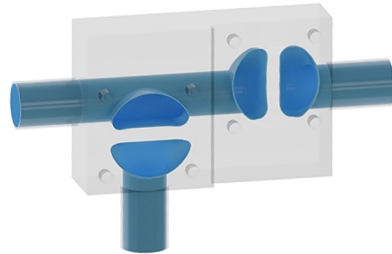
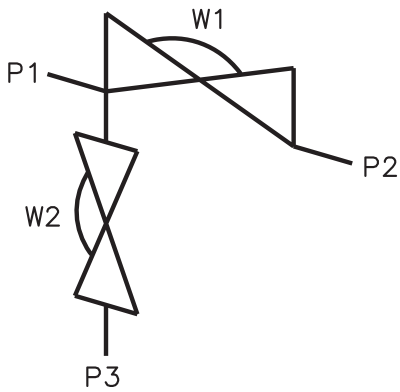

Valve	DN Size	
W1		
W2		
Port	DN Size	Tube Specification
P1		
P2		
P3		

Installation as shown
H = Horizontal
V = Vertical



Serial Weir SW0302V

Front

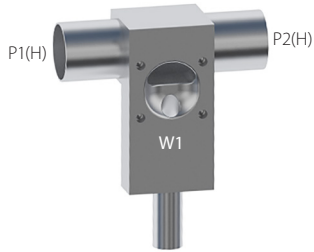

Back

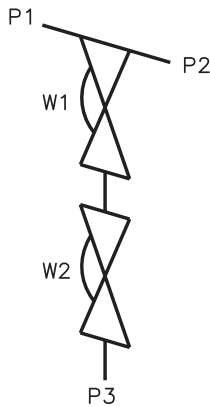

Valve	DN Size	
W1		
W2		
Port	DN Size	Tube Specification
P1		
P2		
P3		

Installation as shown
H = Horizontal
V = Vertical



Serial Weir SW0302W

Front

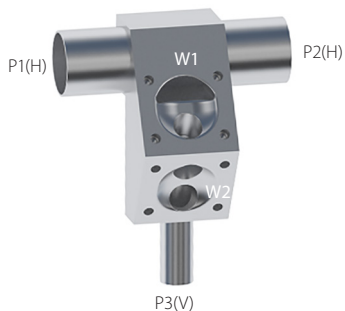

Side

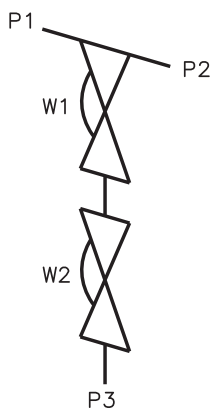

Valve	DN Size	
W1		
W2		
Port	DN Size	Tube Specification
P1		
P2		
P3		

Installation as shown
H = Horizontal
V = Vertical



Serial Weir SW0402A

Front

Side

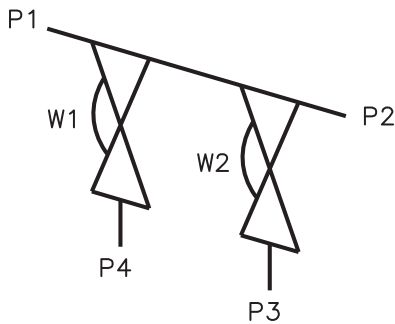
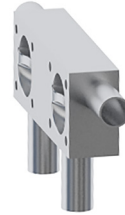
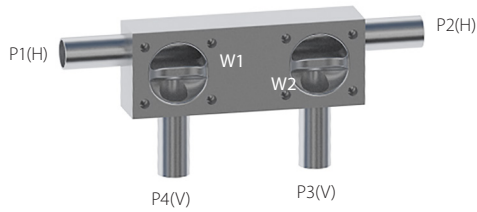

Valve	DN Size	
W1		
W2		
Port	DN Size	Tube Specification
P1		
P2		
P3		
P4		

Installation as shown
H = Horizontal
V = Vertical



Serial Weir SW0402B

Front



Back

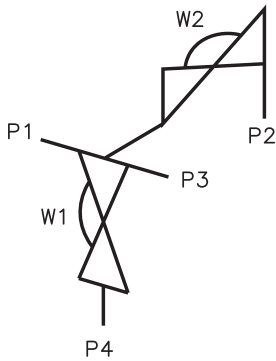

Valve	DN Size	
W1		
W2		
Port	DN Size	Tube Specification
P1		
P2		
P3		
P4		

Installation as shown
H = Horizontal
V = Vertical





Serial Weir SW0402C

Front

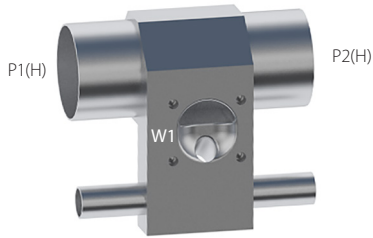

Back

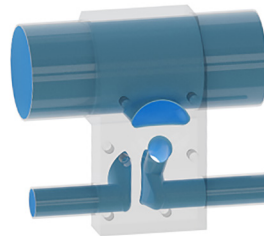
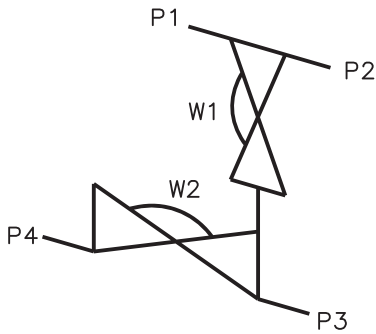
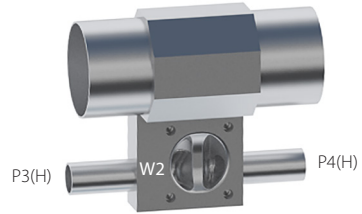

Valve	DN Size	
W1		
W2		
Port	DN Size	Tube Specification
P1		
P2		
P3		
P4		

Installation as shown
H = Horizontal
V = Vertical



Serial Weir SW0402D

Front

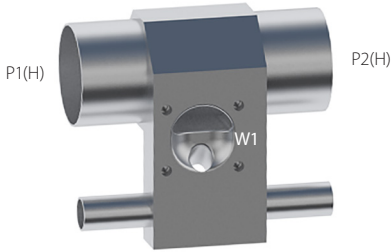

Back

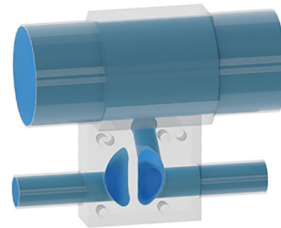
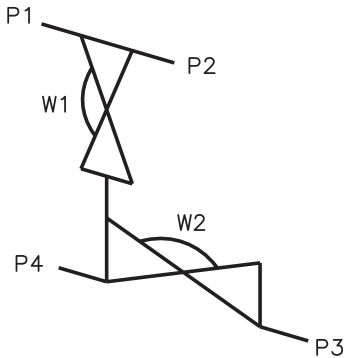
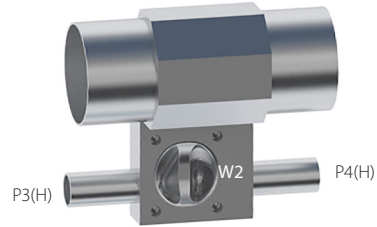

Valve	DN Size	
W1		
W2		
Port	DN Size	Tube Specification
P1		
P2		
P3		
P4		

Installation as shown
H = Horizontal
V = Vertical





Serial Weir SW0402E

Front

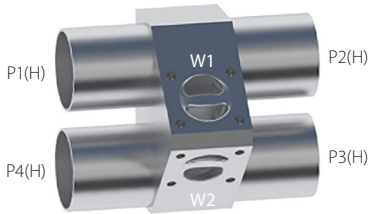

Side

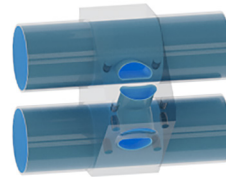
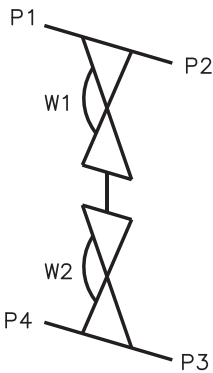
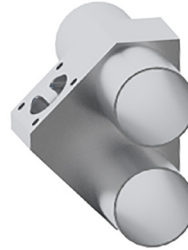

Valve	DN Size	
W1		
W2		
Port	DN Size	Tube Specification
P1		
P2		
P3		
P4		

Installation as shown
H = Horizontal
V = Vertical



Serial Weir SW0402F

Front

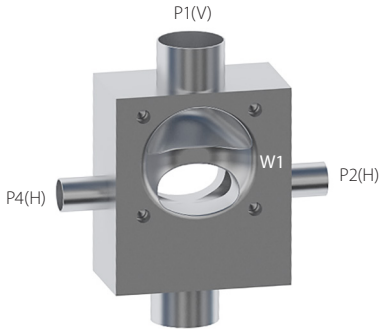

Back

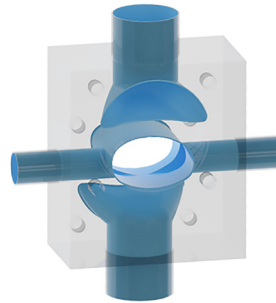
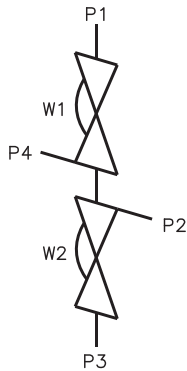
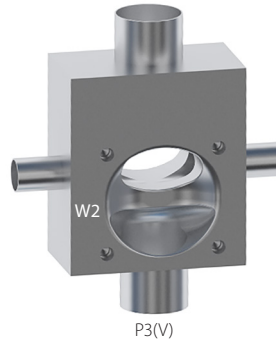

Valve	DN Size	
W1		
W2		
Port	DN Size	Tube Specification
P1		
P2		
P3		
P4		

Installation as shown
H = Horizontal
V = Vertical





Serial Weir SW0402G

Front

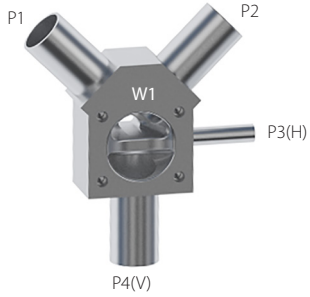

Back

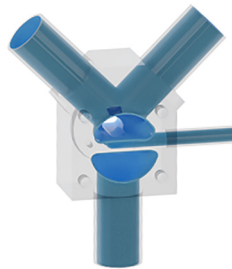
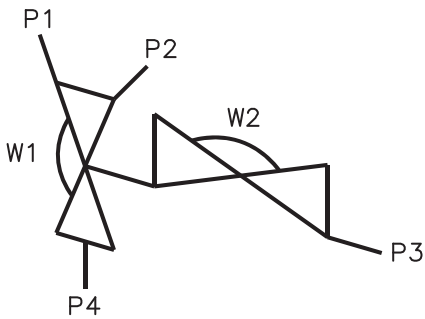

Valve	DN Size	
W1		
W2		
Port	DN Size	Tube Specification
P1		
P2		
P3		
P4		

Installation as shown
H = Horizontal
V = Vertical



Serial Weir SW0402H

Front



Side

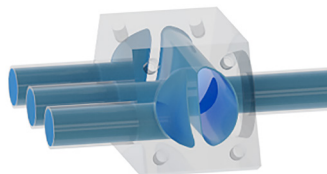
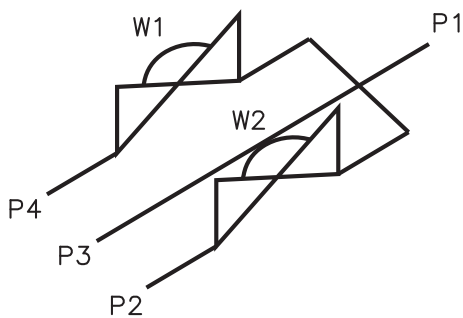
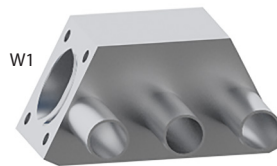

Valve	DN Size	
W1		
W2		
Port	DN Size	Tube Specification
P1		
P2		
P3		
P4		

Installation as shown
H = Horizontal
V = Vertical



Serial Weir SW04021

Front

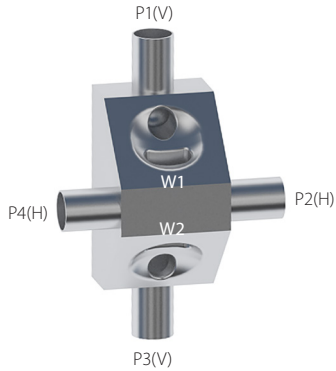

Side

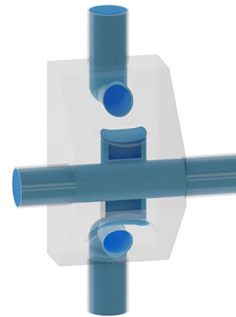
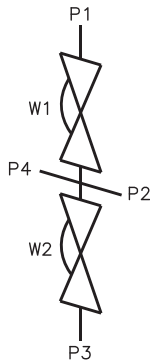
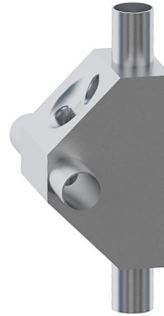

Valve	DN Size	
W1		
W2		
Port	DN Size	Tube Specification
P1		
P2		
P3		
P4		

Installation as shown
H = Horizontal
V = Vertical



Serial Weir SW0402J

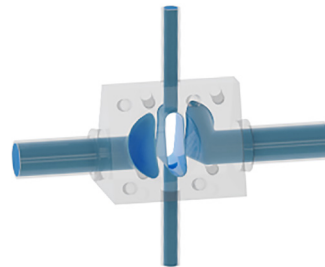
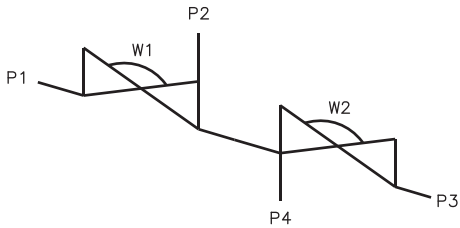
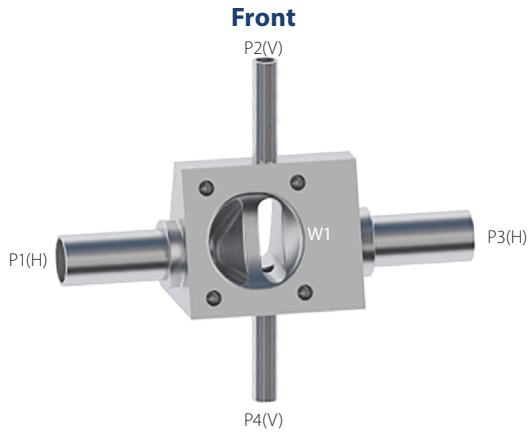

Valve	DN Size	
W1		
W2		
Port	DN Size	Tube Specification
P1		
P2		
P3		
P4		

Installation as shown
H = Horizontal
V = Vertical



Serial Weir SW0402K

Front

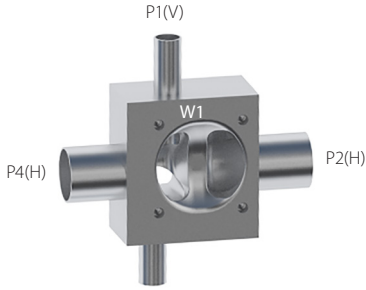

Back

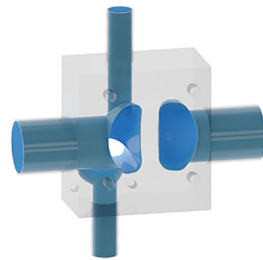
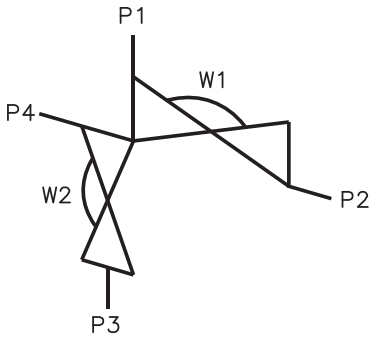
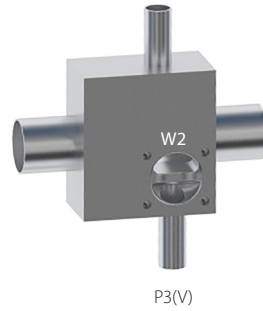

Valve	DN Size	
W1		
W2		
Port	DN Size	Tube Specification
P1		
P2		
P3		
P4		

Installation as shown
H = Horizontal
V = Vertical



Serial Weir SW0402L

Front

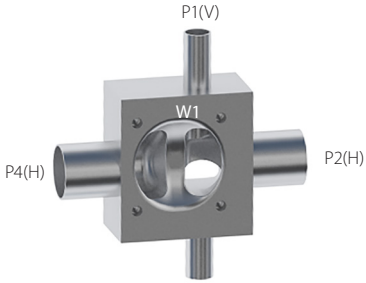

Back

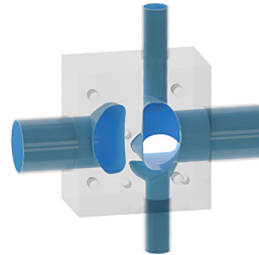
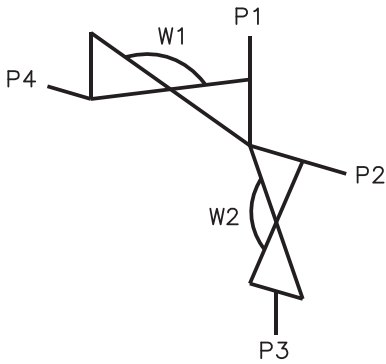
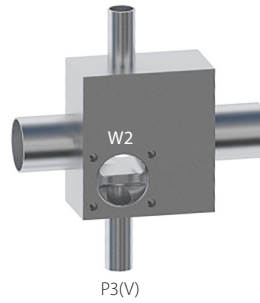

Valve	DN Size	
W1		
W2		
Port	DN Size	Tube Specification
P1		
P2		
P3		
P4		

Installation as shown
H = Horizontal
V = Vertical





Serial Weir SW0402M

Front

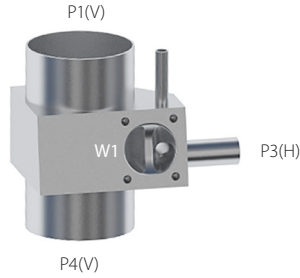

Back

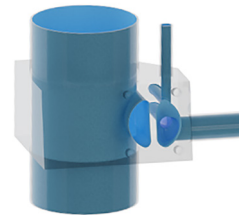
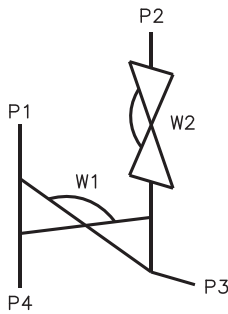
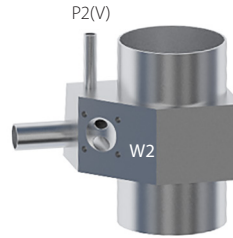

Valve	DN Size	
W1		
W2		
Port	DN Size	Tube Specification
P1		
P2		
P3		
P4		

Installation as shown
H = Horizontal
V = Vertical



Serial Weir SW0402N

Front

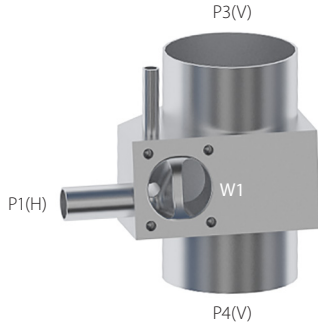

Back

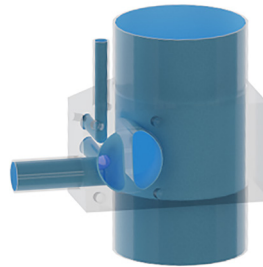
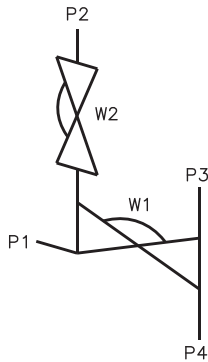
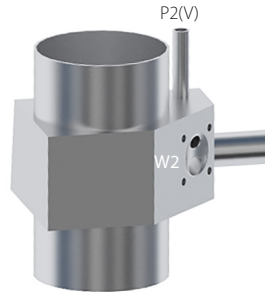

Valve	DN Size	
W1		
W2		
Port	DN Size	Tube Specification
P1		
P2		
P3		
P4		

Installation as shown
H = Horizontal
V = Vertical



Serial Weir SW04020

Front

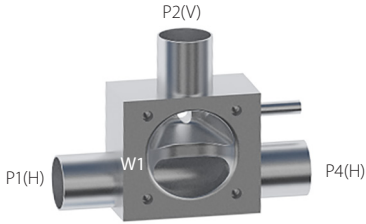

Back

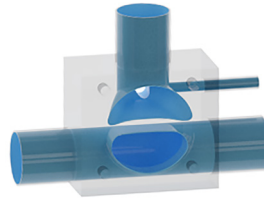
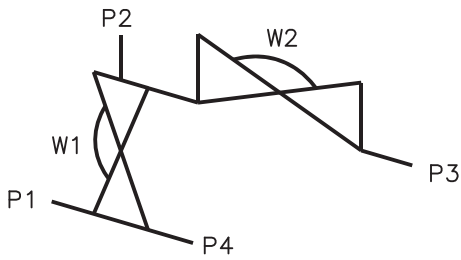
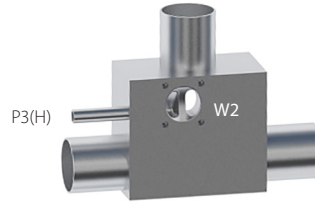

Valve	DN Size	
W1		
W2		
Port	DN Size	Tube Specification
P1		
P2		
P3		
P4		

Installation as shown
H = Horizontal
V = Vertical



Serial Weir SW0402P

Front

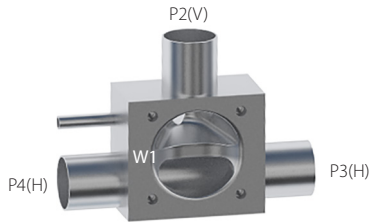

Back

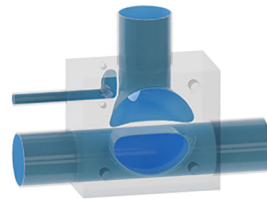
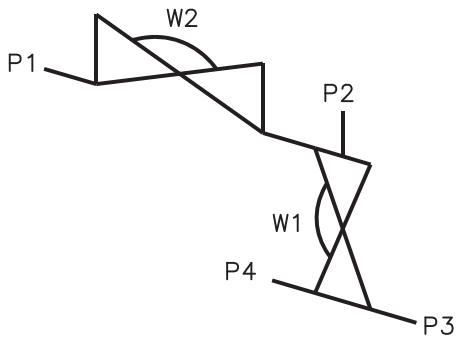

Valve	DN Size	
W1		
W2		
Port	DN Size	Tube Specification
P1		
P2		
P3		
P4		

Installation as shown
H = Horizontal
V = Vertical



Serial Weir SW0402Q

Front

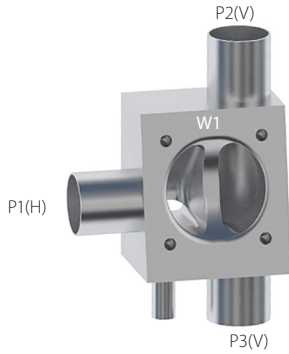

Back

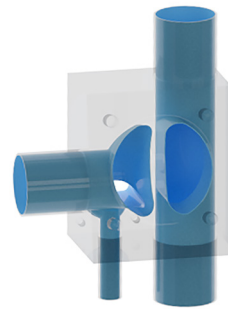
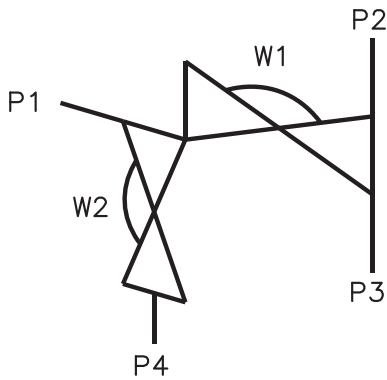

Valve	DN Size	
W1		
W2		
Port	DN Size	Tube Specification
P1		
P2		
P3		
P4		

Installation as shown
H = Horizontal
V = Vertical



Serial Weir SW0402R

Front



Back

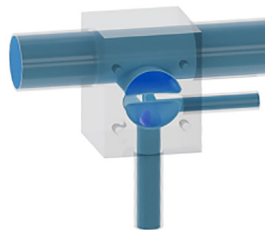
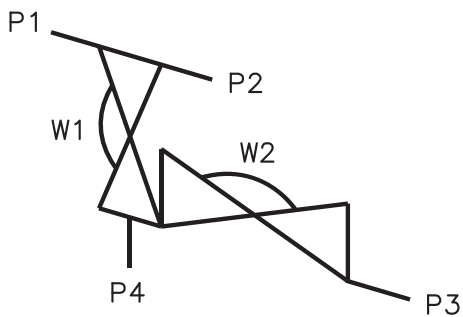
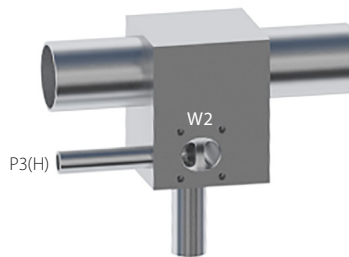

Valve	DN Size	
W1		
W2		
Port	DN Size	Tube Specification
P1		
P2		
P3		
P4		

Installation as shown
H = Horizontal
V = Vertical



Serial Weir SW0402S

Front

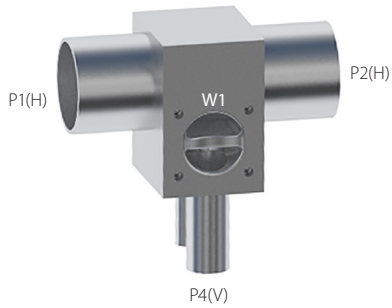

Back

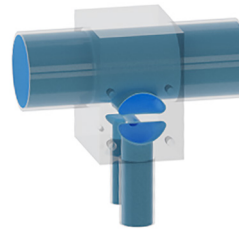
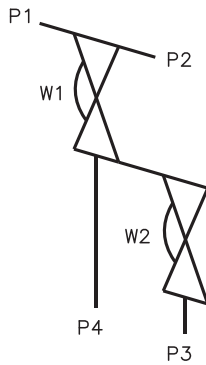

Valve	DN Size	
W1		
W2		
Port	DN Size	Tube Specification
P1		
P2		
P3		
P4		

Installation as shown
H = Horizontal
V = Vertical



Serial Weir SW0402T

Front



Back

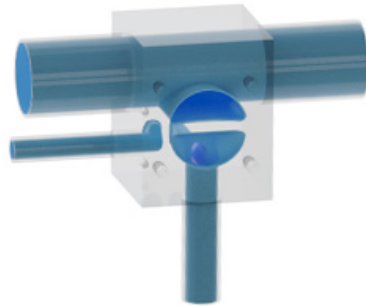
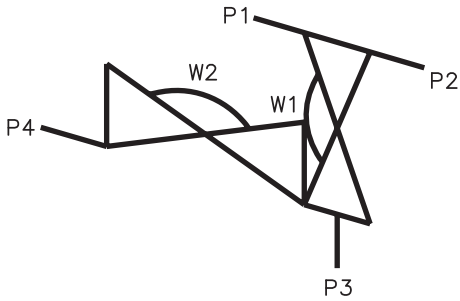

Valve	DN Size	
W1		
W2		
Port	DN Size	Tube Specification
P1		
P2		
P3		
P4		

Installation as shown
H = Horizontal
V = Vertical





Serial Weir SW0402U

Front

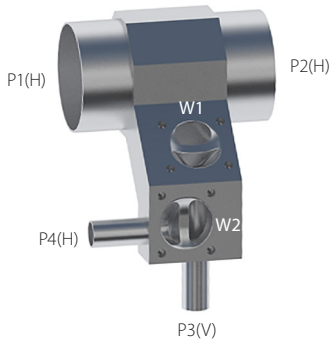

Side

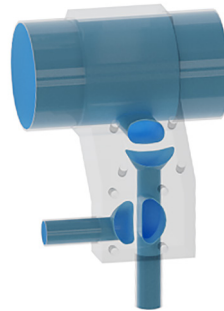
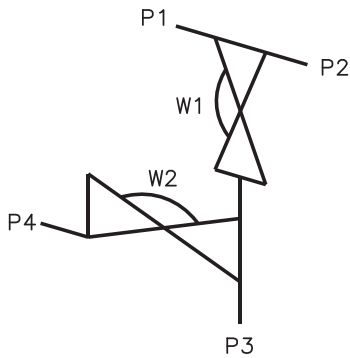

Valve	DN Size	
W1		
W2		
Port	DN Size	Tube Specification
P1		
P2		
P3		
P4		

Installation as shown
H = Horizontal
V = Vertical

Serial Weir SW0402V

Front

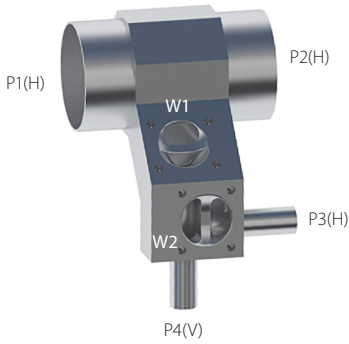

Side

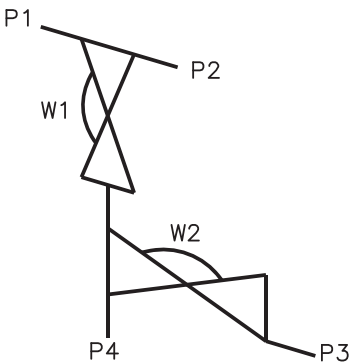

Valve	DN Size	
W1		
W2		
Port	DN Size	Tube Specification
P1		
P2		
P3		
P4		

Installation as shown
H = Horizontal
V = Vertical



Serial Weir SW0402W

Front

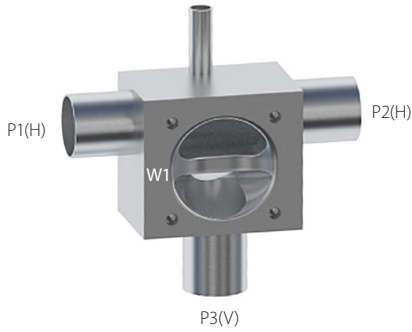

Back

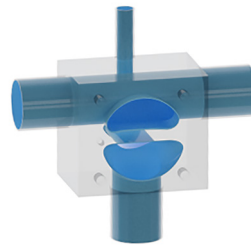
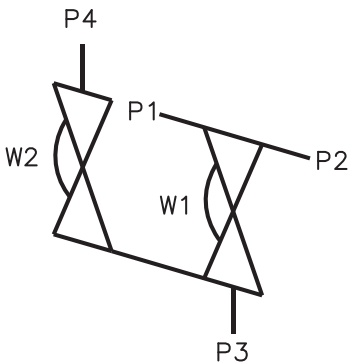
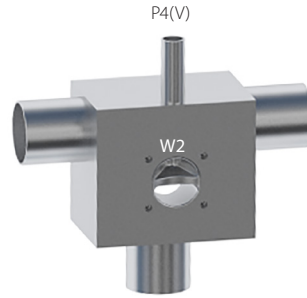

Valve	DN Size	
W1		
W2		
Port	DN Size	Tube Specification
P1		
P2		
P3		
P4		

Installation as shown
H = Horizontal
V = Vertical



Serial Weir SW0402X

Front

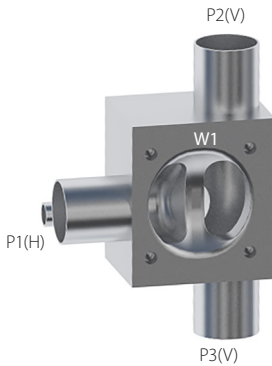

Back

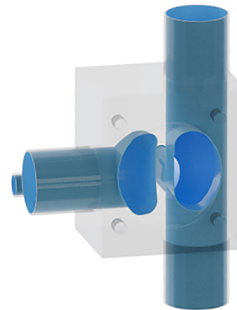
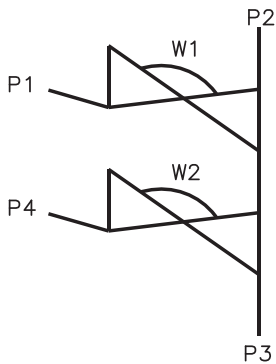
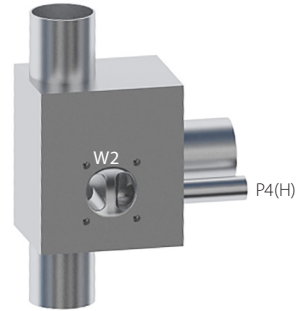

Valve	DN Size	
W1		
W2		
Port	DN Size	Tube Specification
P1		
P2		
P3		
P4		

Installation as shown
H = Horizontal
V = Vertical





Serial Weir SW0502A

Front

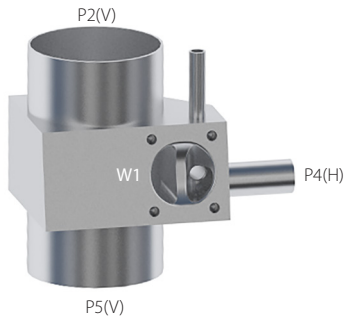

Back

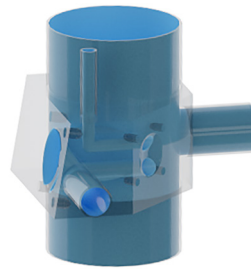
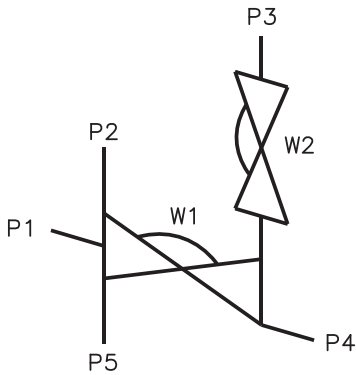
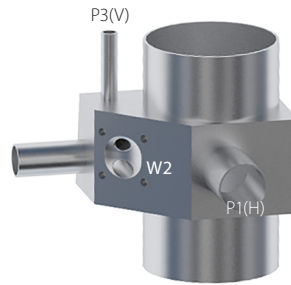

Valve	DN Size	
W1		
W2		
Port	DN Size	Tube Specification
P1		
P2		
P3		
P4		
P5		

Installation as shown
H = Horizontal
V = Vertical



Serial Weir SW0502B

Front

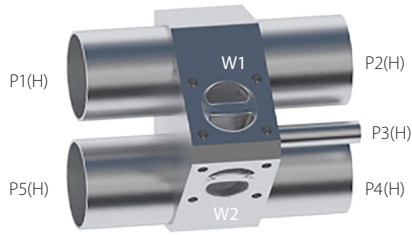

Side

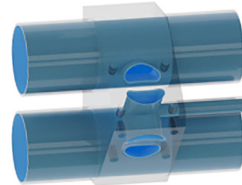
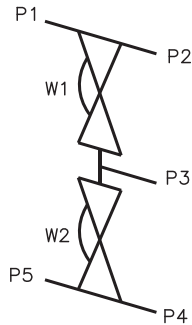
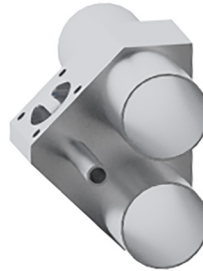

Valve	DN Size	
W1		
W2		
Port	DN Size	Tube Specification
P1		
P2		
P3		
P4		
P5		

Installation as shown
H = Horizontal
V = Vertical



Multiple Weir MW0303A

Front

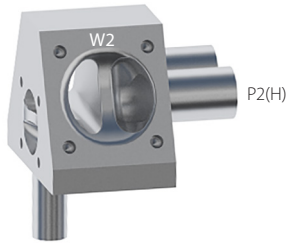

Side

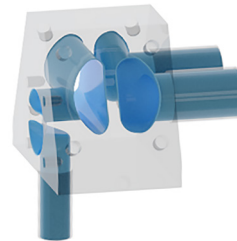
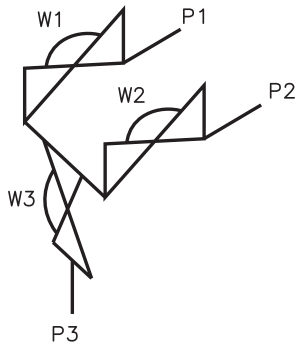
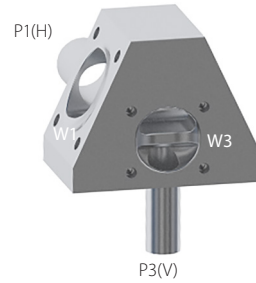

Valve	DN Size	
W1		
W2		
W3		
Port	DN Size	Tube Specification
P1		
P2		
P3		

Installation as shown
H = Horizontal
V = Vertical



Multiple Weir MW0303B

Front

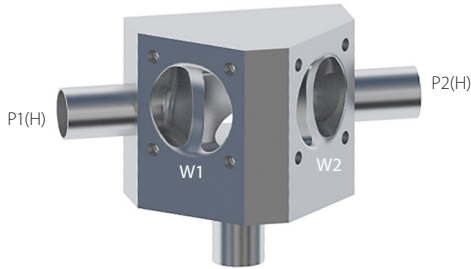

Back

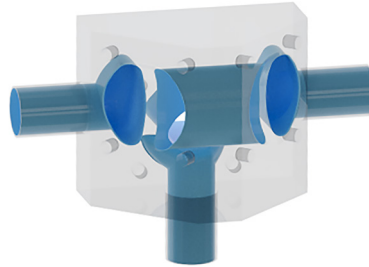
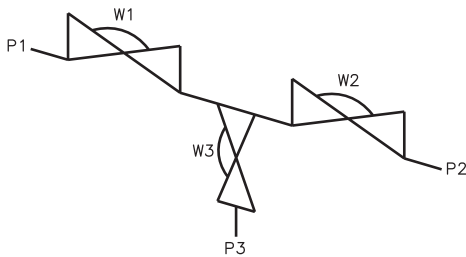
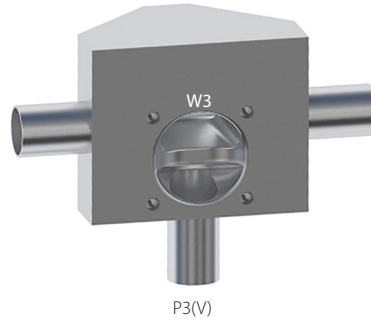

Valve	DN Size	
W1		
W2		
W3		
Port	DN Size	Tube Specification
P1		
P2		
P3		

Installation as shown
H = Horizontal
V = Vertical



Multiple Weir MW0303C

Front

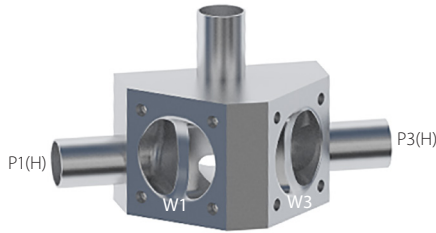

Back

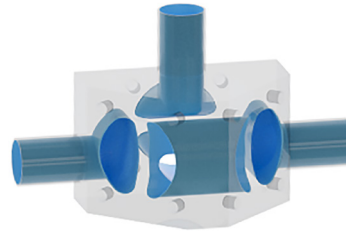
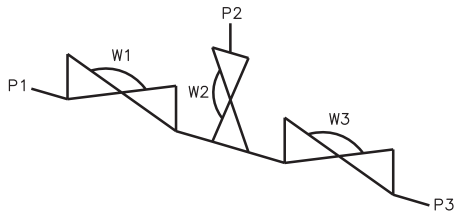
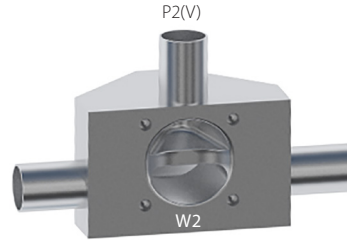

Valve	DN Size	
W1		
W2		
W3		
Port	DN Size	Tube Specification
P1		
P2		
P3		

Installation as shown
H = Horizontal
V = Vertical



Multiple Weir MW0403A

Front

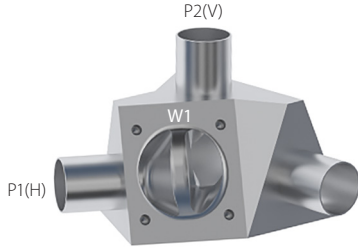

Side

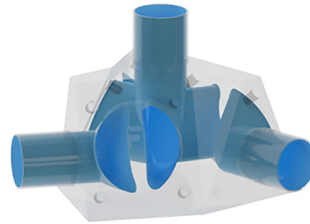
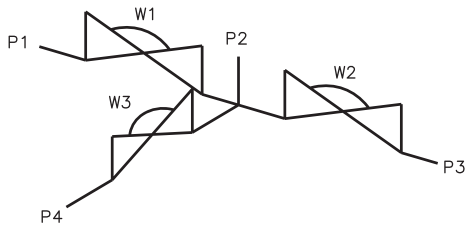

Valve	DN Size	
W1		
W2		
W3		
Port	DN Size	Tube Specification
P1		
P2		
P3		
P4		

Installation as shown
H = Horizontal
V = Vertical



Multiple Weir **MW0403B**

Front

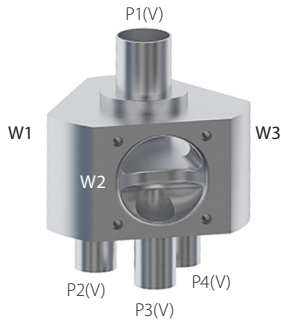

Side

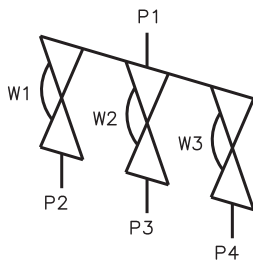

Valve	DN Size	
W1		
W2		
W3		
Port	DN Size	Tube Specification
P1		
P2		
P3		
P4		

Installation as shown
H = Horizontal
V = Vertical



Multiple Weir MW0403C

Front

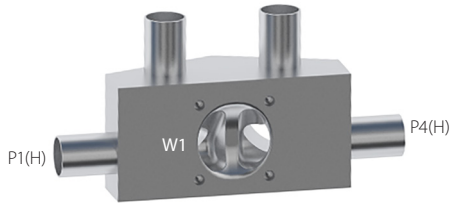

Back

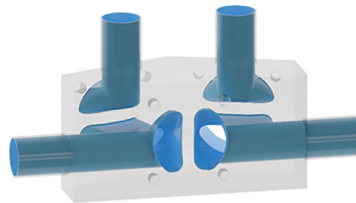
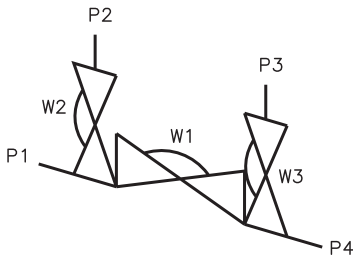
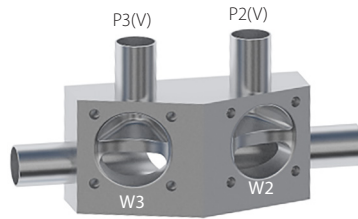

Valve	DN Size	
W1		
W2		
W3		
Port	DN Size	Tube Specification
P1		
P2		
P3		
P4		

Installation as shown
H = Horizontal
V = Vertical



Multiple Weir MW0403D

Front

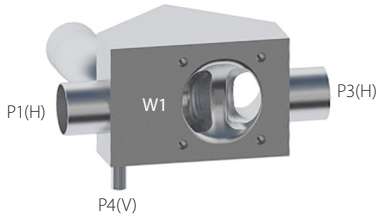

Side

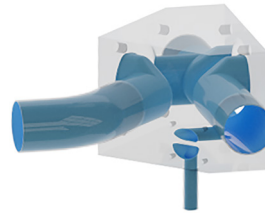
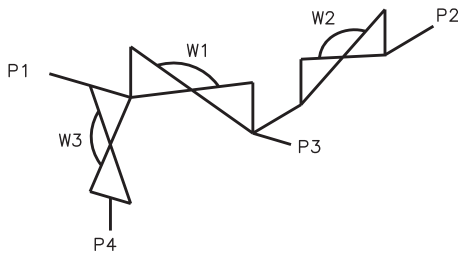
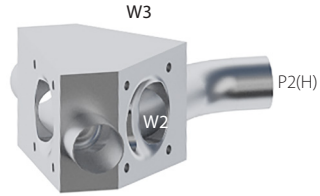

Valve	DN Size	
W1		
W2		
W3		
Port	DN Size	Tube Specification
P1		
P2		
P3		
P4		

Installation as shown
H = Horizontal
V = Vertical



Multiple Weir MW0403E

Front

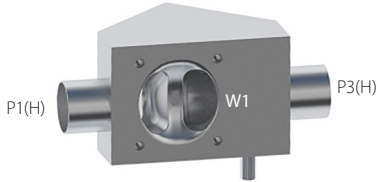

Side

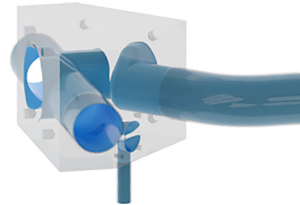
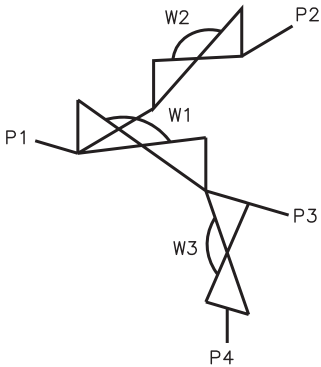
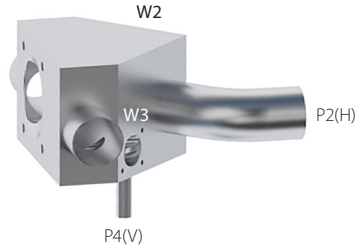

Valve	DN Size	
W1		
W2		
W3		
Port	DN Size	Tube Specification
P1		
P2		
P3		
P4		

Installation as shown
H = Horizontal
V = Vertical



Multiple Weir MW0403F

Front

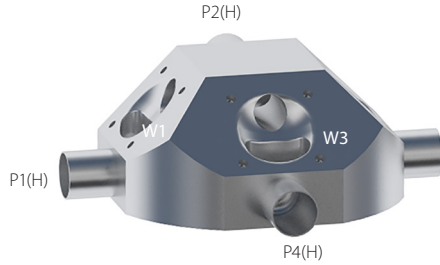

Side

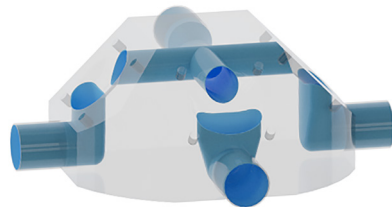
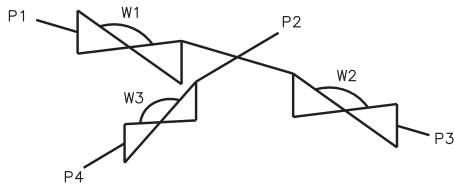

Valve	DN Size	
W1		
W2		
W3		
Port	DN Size	Tube Specification
P1		
P2		
P3		
P4		

Installation as shown
H = Horizontal
V = Vertical



Multiple Weir MW0403G

Front



Back

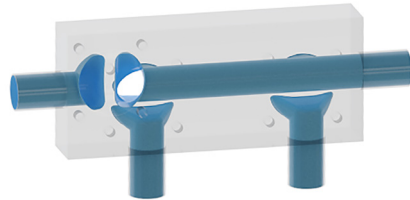
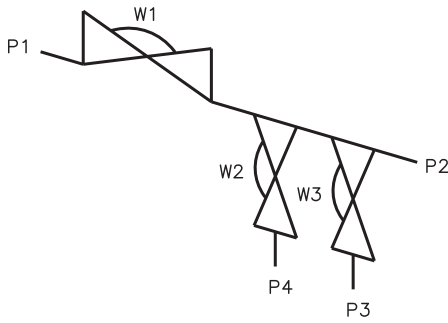

Valve	DN Size	
W1		
W2		
W3		
Port	DN Size	Tube Specification
P1		
P2		
P3		
P4		

Installation as shown
H = Horizontal
V = Vertical



Multiple Weir MW0403H

Front

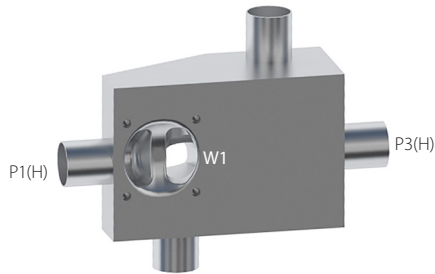

Back

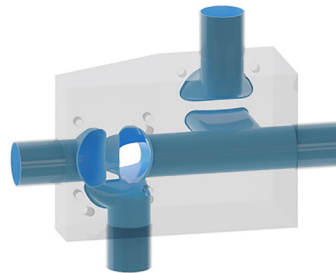
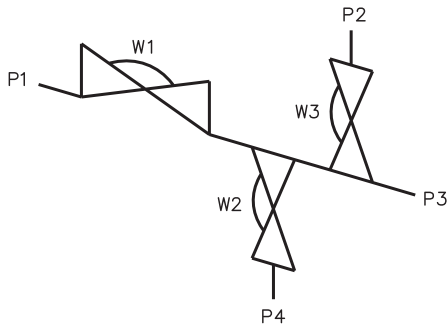
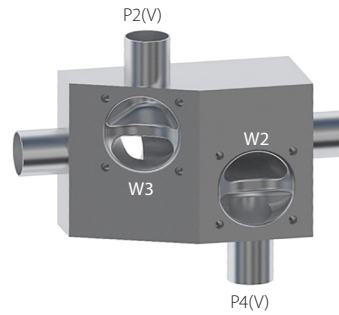

Valve	DN Size	
W1		
W2		
W3		
Port	DN Size	Tube Specification
P1		
P2		
P3		
P4		

Installation as shown
H = Horizontal
V = Vertical



Multiple Weir MW04031

Front



Back

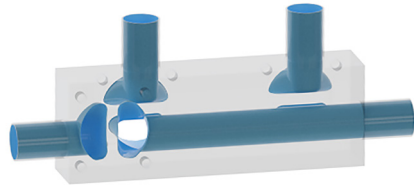
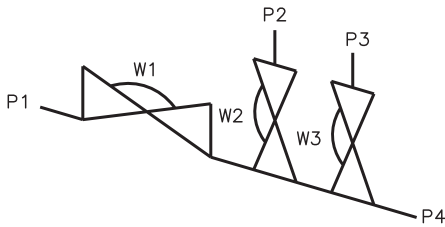
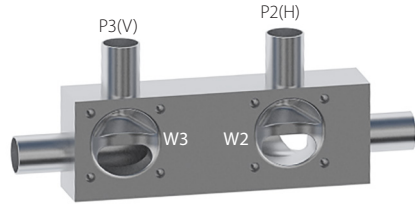

Valve	DN Size	
W1		
W2		
W3		
Port	DN Size	Tube Specification
P1		
P2		
P3		
P4		

Installation as shown
H = Horizontal
V = Vertical



Multiple Weir MW0403J

Front



Back

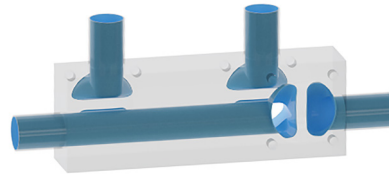
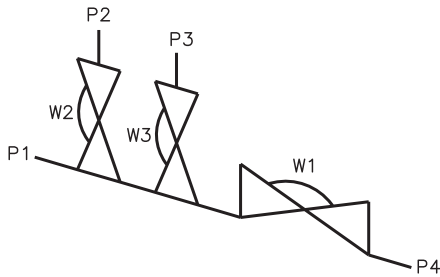
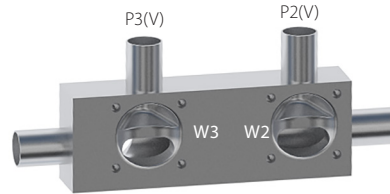

Valve	DN Size	
W1		
W2		
W3		
Port	DN Size	Tube Specification
P1		
P2		
P3		
P4		

Installation as shown
H = Horizontal
V = Vertical



Multiple Weir MW0403K

Front

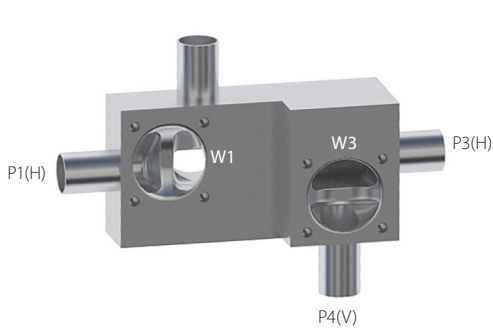

Back

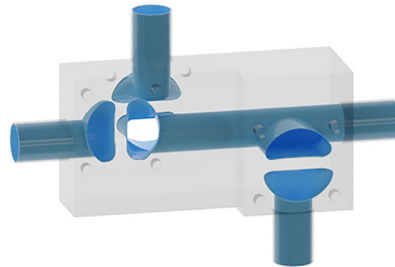
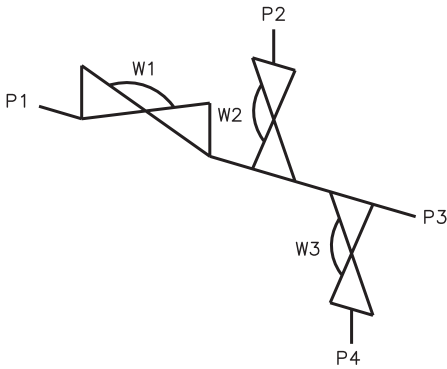
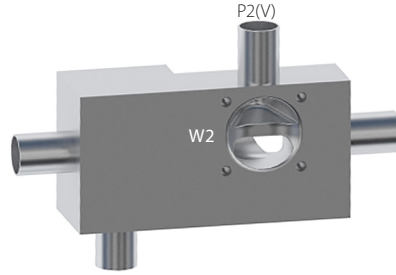

Valve	DN Size	
W1		
W2		
W3		
Port	DN Size	Tube Specification
P1		
P2		
P3		
P4		

Installation as shown
H = Horizontal
V = Vertical



Multiple Weir MW0403L

Front



Back

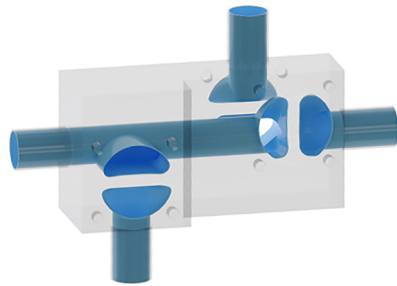
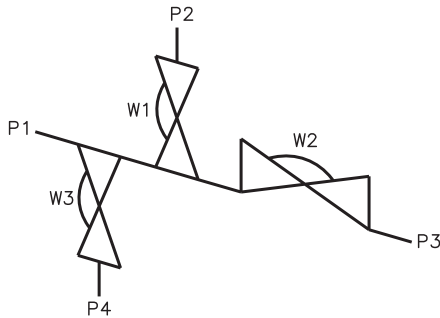
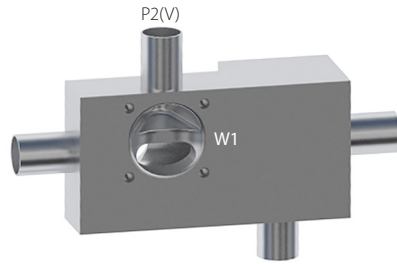

Valve	DN Size	
W1		
W2		
W3		
Port	DN Size	Tube Specification
P1		
P2		
P3		
P4		

Installation as shown
H = Horizontal
V = Vertical



Multiple Weir MW0403M

Front

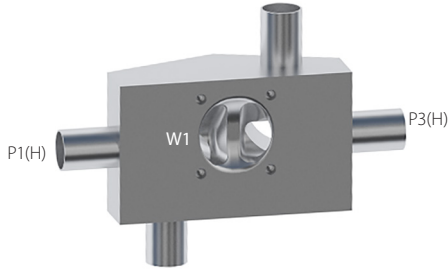

Back

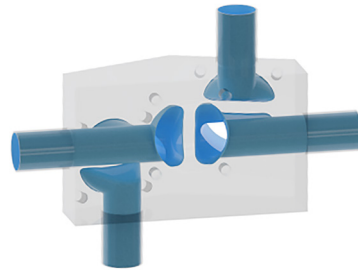
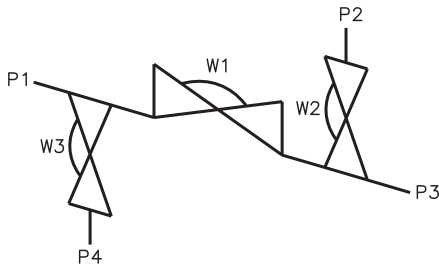
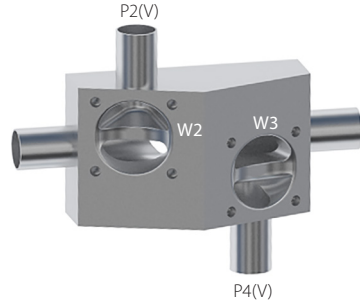

Valve	DN Size	
W1		
W2		
W3		
Port	DN Size	Tube Specification
P1		
P2		
P3		
P4		

Installation as shown
H = Horizontal
V = Vertical



Multiple Weir MW0403N

Front

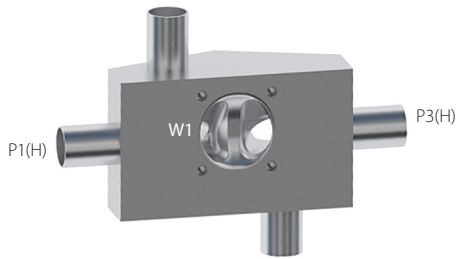

Back

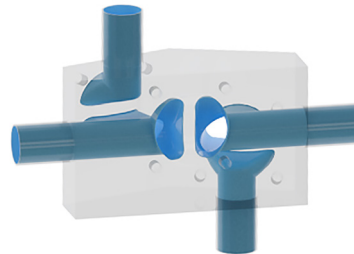
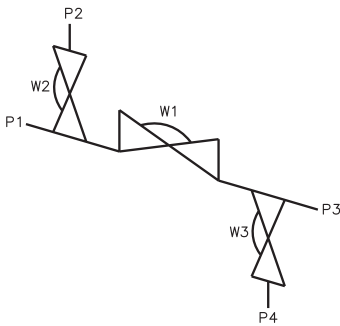
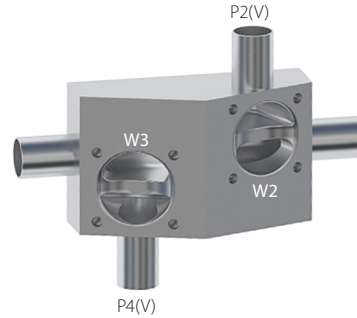

Valve	DN Size	
W1		
W2		
W3		
Port	DN Size	Tube Specification
P1		
P2		
P3		
P4		

Installation as shown
H = Horizontal
V = Vertical



Multiple Weir MW04030

Front



Back

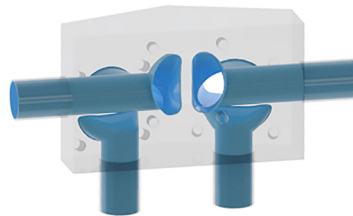
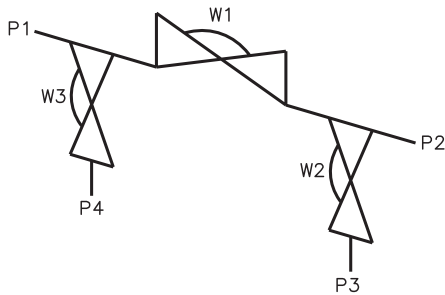
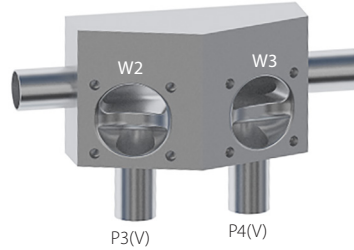

Valve	DN Size	
W1		
W2		
W3		
Port	DN Size	Tube Specification
P1		
P2		
P3		
P4		

Installation as shown
H = Horizontal
V = Vertical



Multiple Weir MW0403P

Front

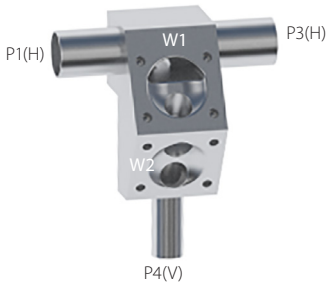

Back

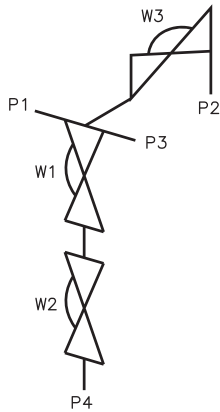

Valve	DN Size	
W1		
W2		
W3		
Port	DN Size	Tube Specification
P1		
P2		
P3		
P4		

Installation as shown
H = Horizontal
V = Vertical



Multiple Weir MW0403Q

Front



Back

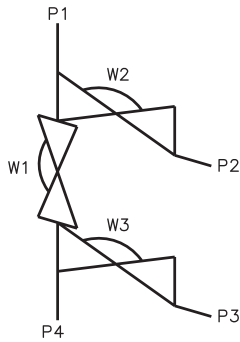
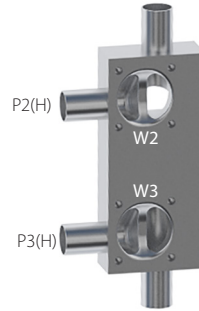

Valve	DN Size	
W1		
W2		
W3		
Port	DN Size	Tube Specification
P1		
P2		
P3		
P4		

Installation as shown
H = Horizontal
V = Vertical



Multiple Weir MW0403R

Front



Back

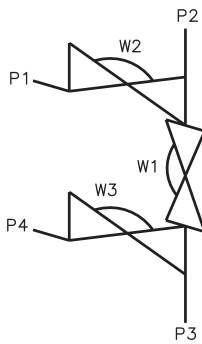
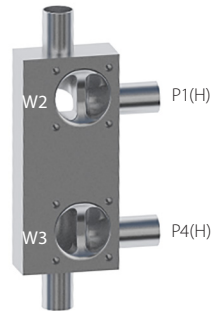

Valve	DN Size	
W1		
W2		
W3		
Port	DN Size	Tube Specification
P1		
P2		
P3		
P4		

Installation as shown
H = Horizontal
V = Vertical



Multiple Weir MW0503A

Front

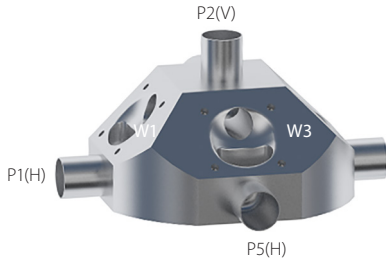

Side

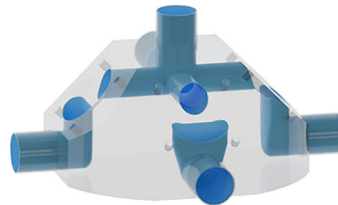
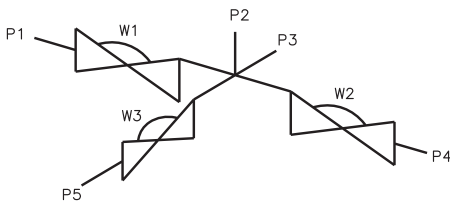
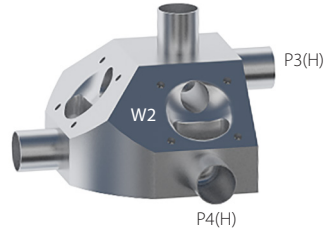

Valve	DN Size	
W1		
W2		
W3		
Port	DN Size	Tube Specification
P1		
P2		
P3		
P4		
P5		

Installation as shown
H = Horizontal
V = Vertical



Multiple Weir MW0503B

Front



Back

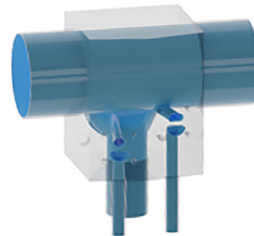
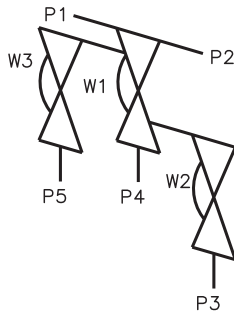
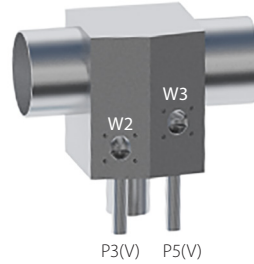

Valve	DN Size	
W1		
W2		
W3		
Port	DN Size	Tube Specification
P1		
P2		
P3		
P4		
P5		

Installation as shown
H = Horizontal
V = Vertical



Multiple Weir MW0503C

Front



Back

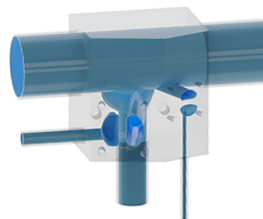
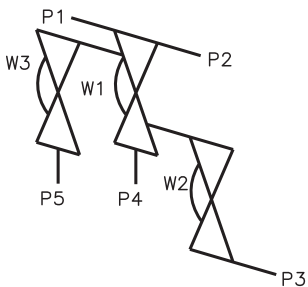
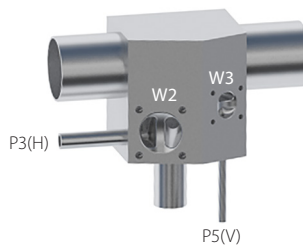

Valve	DN Size	
W1		
W2		
W3		
Port	DN Size	Tube Specification
P1		
P2		
P3		
P4		
P5		

Installation as shown
H = Horizontal
V = Vertical



Multiple Weir MW0503D

Front

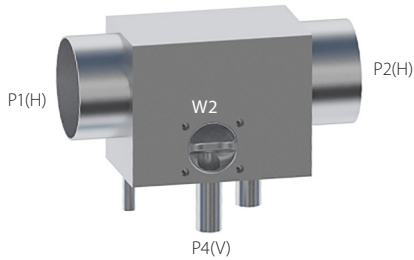

Back

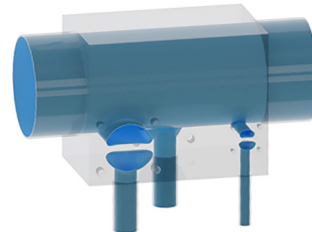
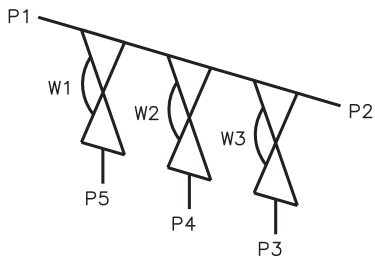
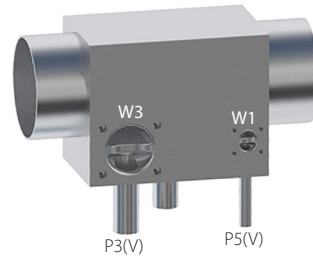

Valve	DN Size	
W1		
W2		
W3		
Port	DN Size	Tube Specification
P1		
P2		
P3		
P4		
P5		

Installation as shown
H = Horizontal
V = Vertical



Multiple Weir MW0503E

Front

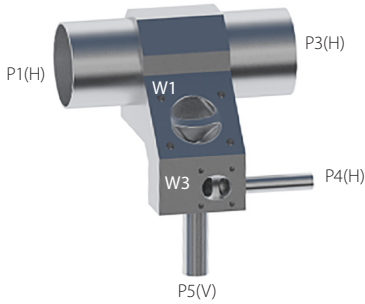

Back

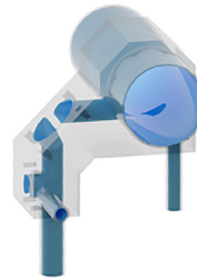
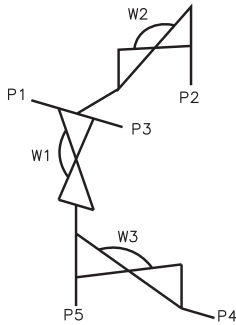
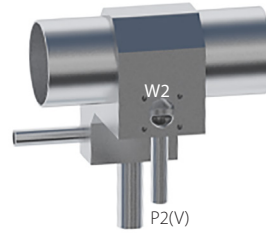

Valve	DN Size	
W1		
W2		
W3		
Port	DN Size	Tube Specification
P1		
P2		
P3		
P4		
P5		

Installation as shown
H = Horizontal
V = Vertical



Multiple Weir MW0503F

Front

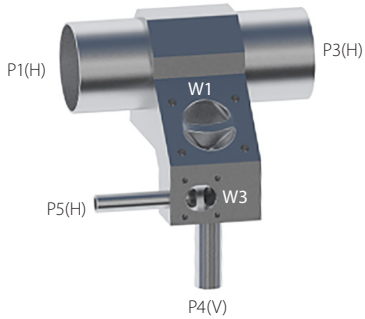

Back

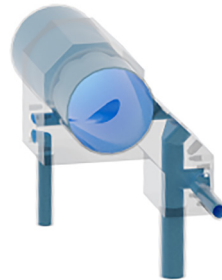
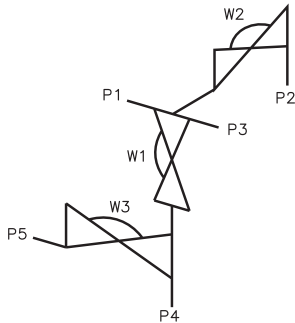

Valve	DN Size	
W1		
W2		
W3		
Port	DN Size	Tube Specification
P1		
P2		
P3		
P4		
P5		

Installation as shown
H = Horizontal
V = Vertical



Multiple Weir MW0503G

Front



Side

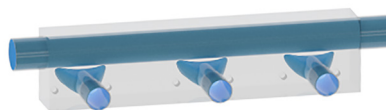
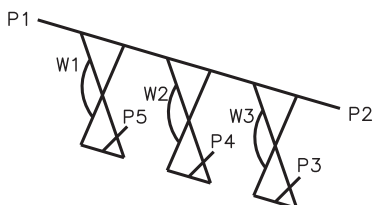

Valve	DN Size	
W1		
W2		
W3		
Port	DN Size	Tube Specification
P1		
P2		
P3		
P4		
P5		

Installation as shown
H = Horizontal
V = Vertical



Multiple Weir MW0404A

Front

Side

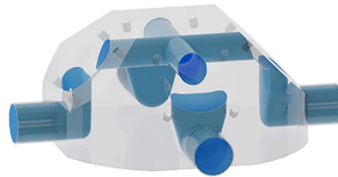
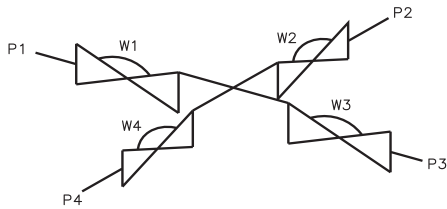
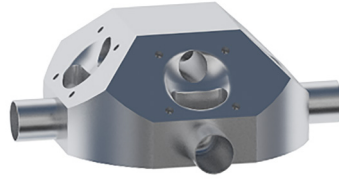
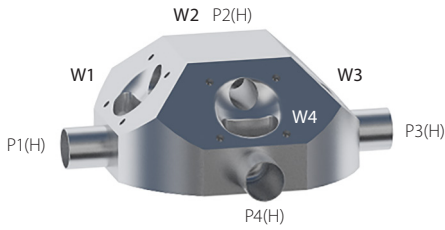

Valve	DN Size	
W1		
W2		
W3		
W4		
Port	DN Size	Tube Specification
P1		
P2		
P3		
P4		

Installation as shown
H = Horizontal
V = Vertical



Multiple Weir MW0404B

Front

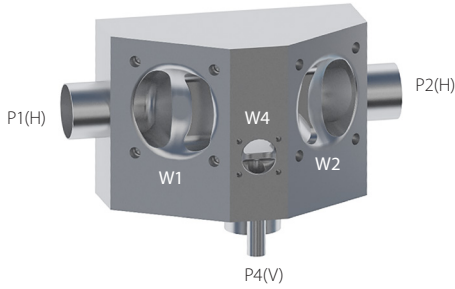

Back

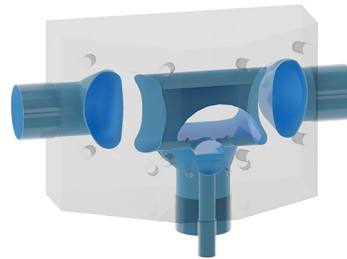
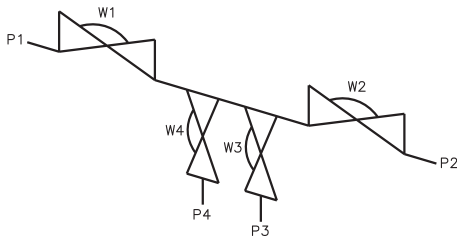

Valve	DN Size	
W1		
W2		
W3		
W4		
Port	DN Size	Tube Specification
P1		
P2		
P3		
P4		

Installation as shown
H = Horizontal
V = Vertical



Multiple Weir MW0404C

Front

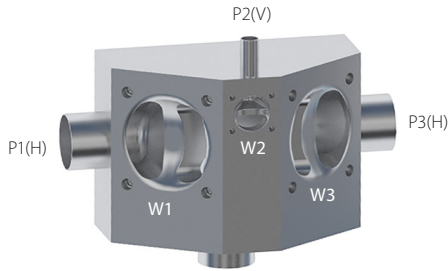

Back

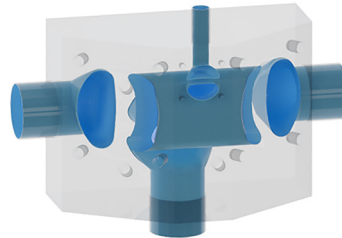
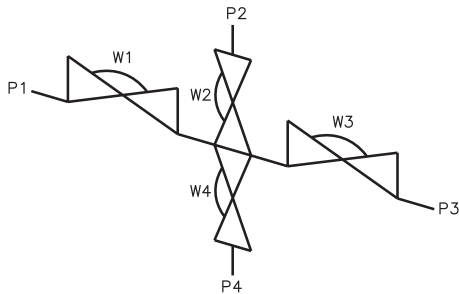
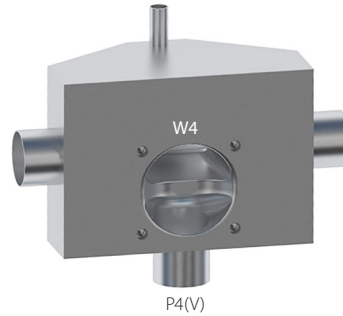

Valve	DN Size	
W1		
W2		
W3		
W4		
Port	DN Size	Tube Specification
P1		
P2		
P3		
P4		

Installation as shown
H = Horizontal
V = Vertical

Multiple Weir MW0404D

Front

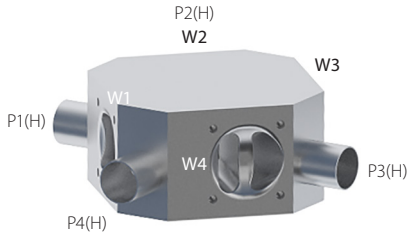

Side

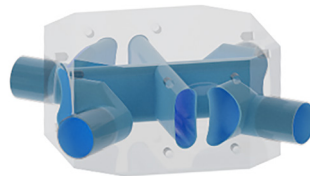
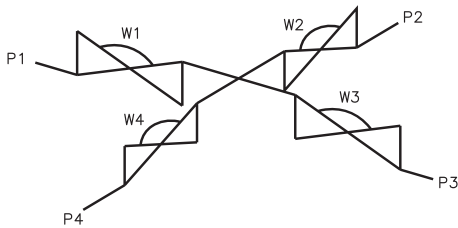
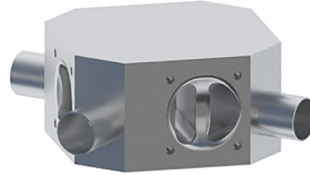

Valve	DN Size	
W1		
W2		
W3		
W4		
Port	DN Size	Tube Specification
P1		
P2		
P3		
P4		

Installation as shown
H = Horizontal
V = Vertical



Multiple Weir MW0405A

Front

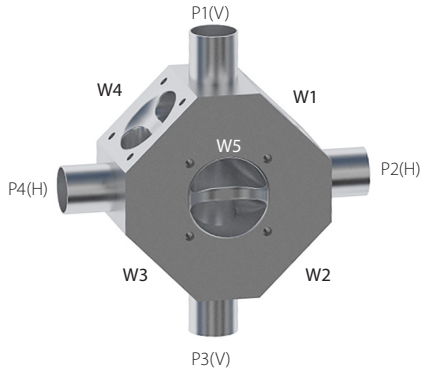

Side

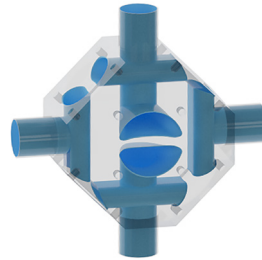
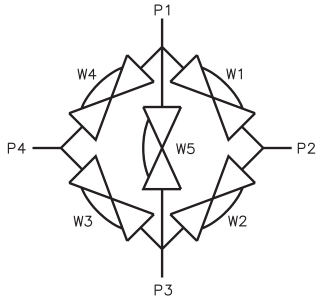
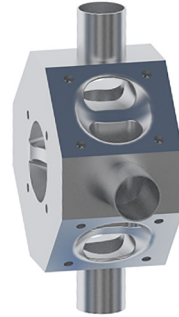

Valve	DN Size	
W1		
W2		
W3		
W4		
W5		
Port	DN Size	Tube Specification
P1		
P2		
P3		
P4		

Installation as shown
H = Horizontal
V = Vertical



Multiple Weir MW0406A

Front

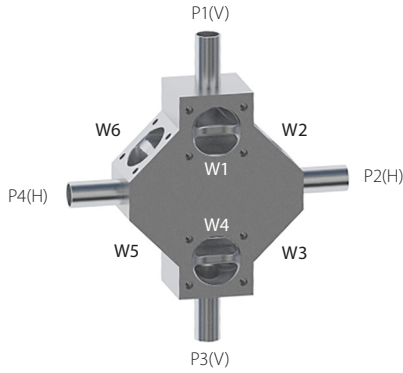

Side

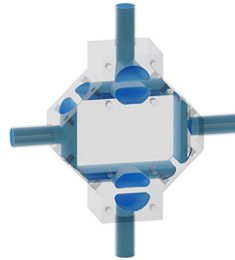
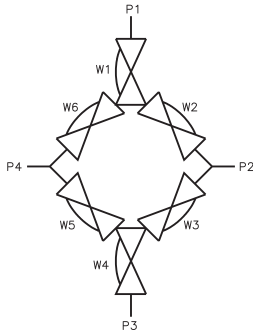
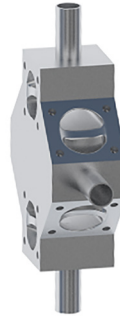

Valve	DN Size	
W1		
W2		
W3		
W4		
W5		
W6		
Port	DN Size	Tube Specification
P1		
P2		
P3		
P4		

Installation as shown
H = Horizontal
V = Vertical





Multiple Weir MW0504A

Front

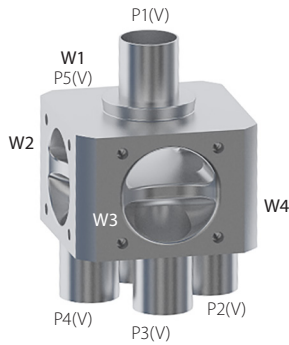

Side

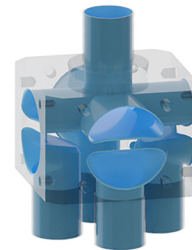
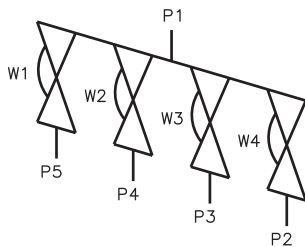
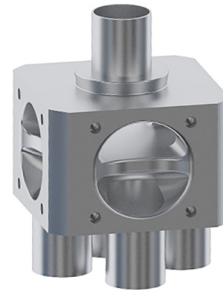

Valve	DN Size	
W1		
W2		
W3		
W4		
Port	DN Size	Tube Specification
P1		
P2		
P3		
P4		
P5		

Installation as shown
H = Horizontal
V = Vertical



Multiple Weir MW0504B

Front

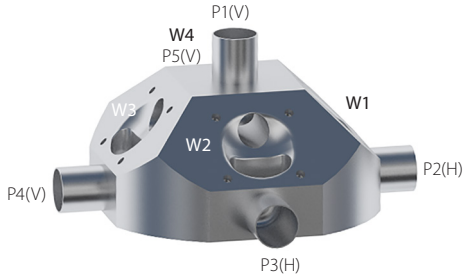

Side

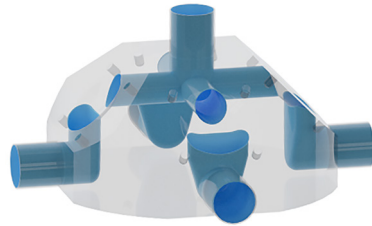
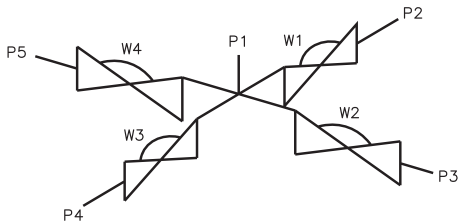
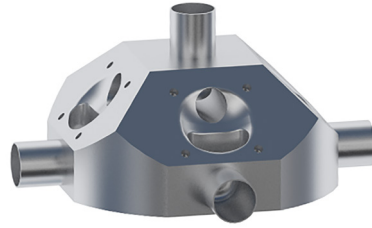

Valve	DN Size	
W1		
W2		
W3		
W4		
Port	DN Size	Tube Specification
P1		
P2		
P3		
P4		
P5		

Installation as shown
H = Horizontal
V = Vertical



Multiple Weir MW0504C

Front

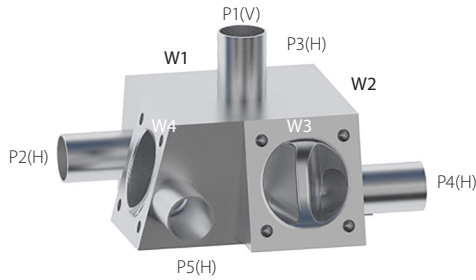

Side

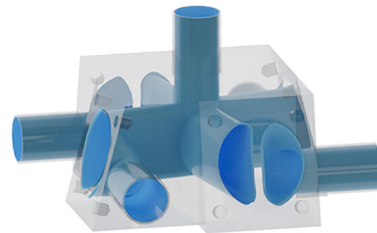
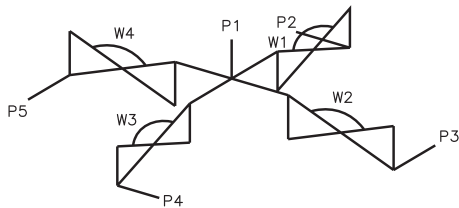
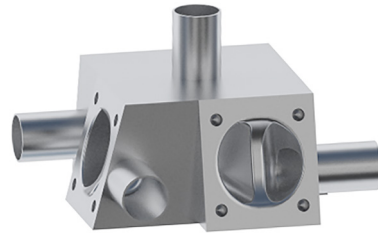

Valve	DN Size	
W1		
W2		
W3		
W4		
Port	DN Size	Tube Specification
P1		
P2		
P3		
P4		
P5		

Installation as shown
H = Horizontal
V = Vertical



Multiple Weir MW0604A

Front

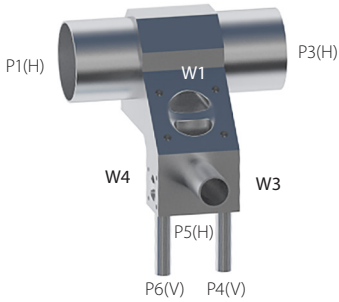

Back

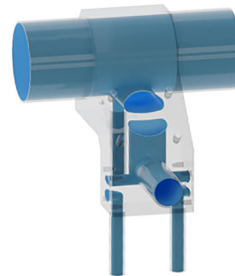
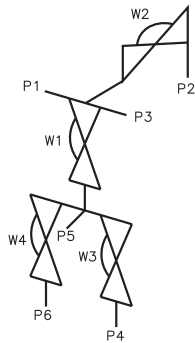
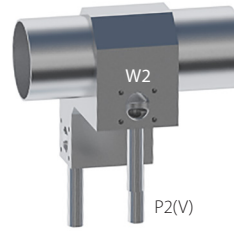

Valve	DN Size	
W1		
W2		
W3		
W4		
Port	DN Size	Tube Specification
P1		
P2		
P3		
P4		
P5		
P6		

Installation as shown
H = Horizontal
V = Vertical





Multiple Weir MW0605A

Front



Side

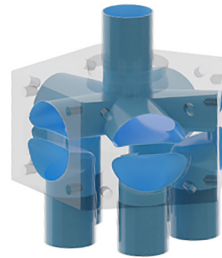
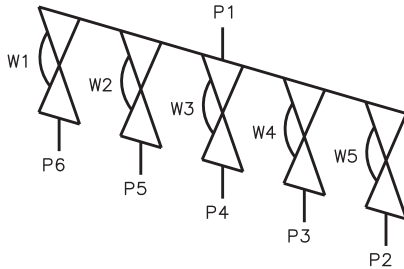
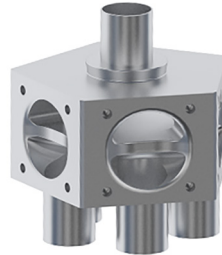

Valve	DN Size	
W1		
W2		
W3		
W4		
W5		
Port	DN Size	Tube Specification
P1		
P2		
P3		
P4		
P5		
P6		

Installation as shown
H = Horizontal
V = Vertical



Multiple Weir MW0605B

Front

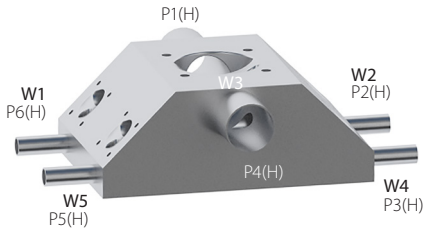

Side

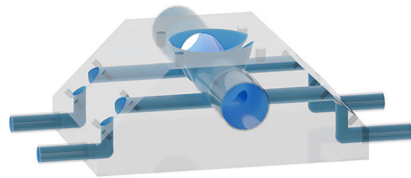
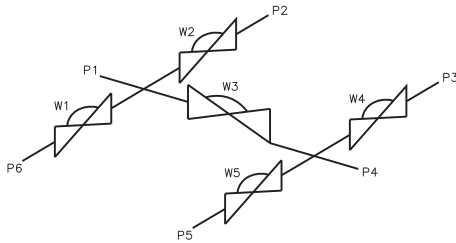
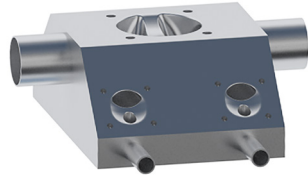

Valve	DN Size	
W1		
W2		
W3		
W4		
W5		
Port	DN Size	Tube Specification
P1		
P2		
P3		
P4		
P5		
P6		

Installation as shown
H = Horizontal
V = Vertical



Multiple Weir MW0705A

Front

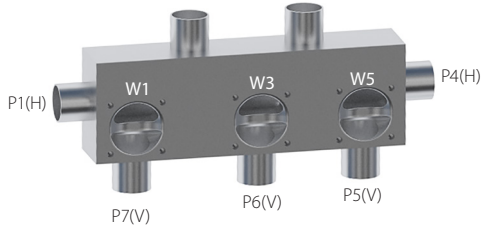

Back

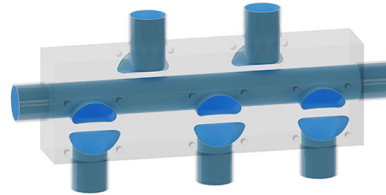
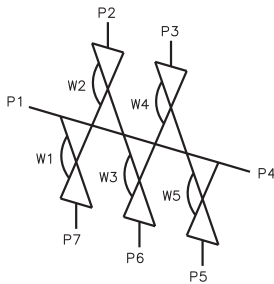
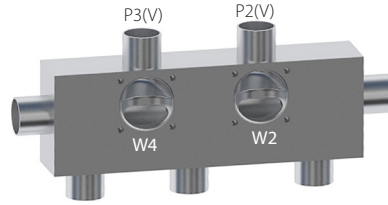

Valve	DN Size	
W1		
W2		
W3		
W4		
W5		
Port	DN Size	Tube Specification
P1		
P2		
P3		
P4		
P5		
P6		
P7		

Installation as shown
H = Horizontal
V = Vertical



Multiple Weir MW0705B

Front

Side

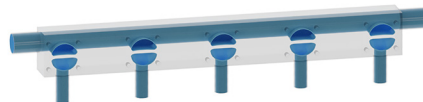
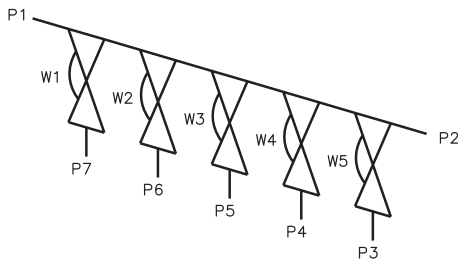
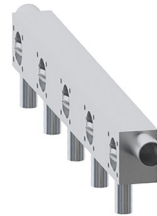
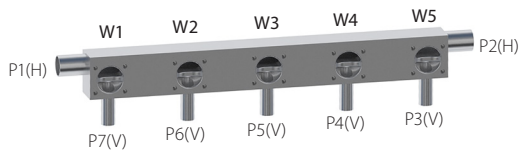

Valve	DN Size	
W1		
W2		
W3		
W4		
W5		
Port	DN Size	Tube Specification
P1		
P2		
P3		
P4		
P5		
P6		
P7		

Installation as shown
H = Horizontal
V = Vertical



Multiple Weir MW0706A

Front

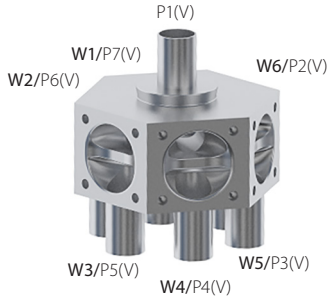

Side

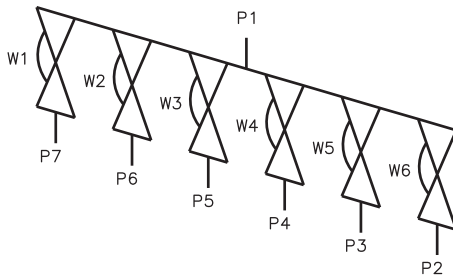
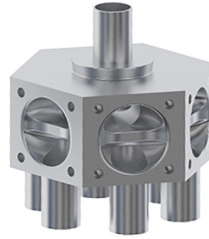

Valve	DN Size	
W1		
W2		
W3		
W4		
W5		
Port	DN Size	Tube Specification
P1		
P2		
P3		
P4		
P5		
P6		
P7		

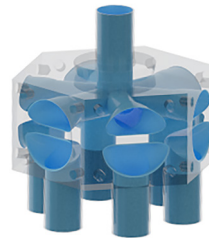

Installation as shown
H = Horizontal
V = Vertical



Multiple Weir MW0908A

Front

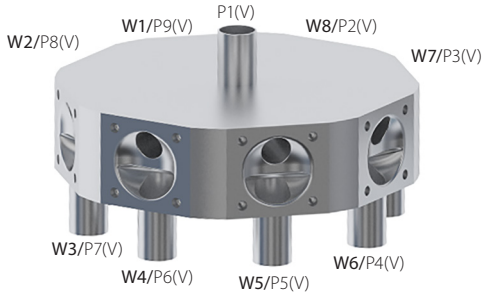

Side

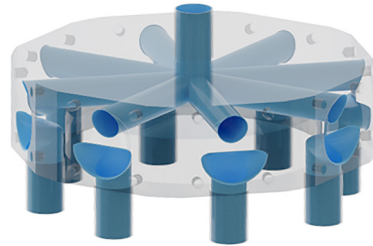
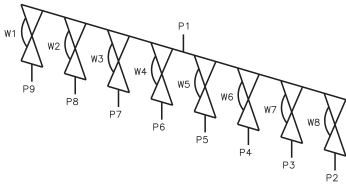
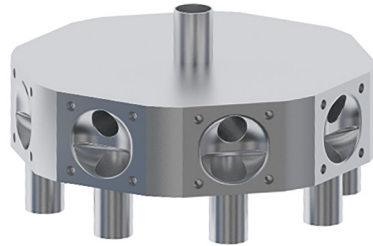

Valve	DN Size	
W1		
W2		
W3		
W4		
W5		
W6		
W7		
W8		
Port	DN Size	Tube Specification
P1		
P2		
P3		
P4		
P5		
P6		
P7		
P8		
P9		

Installation as shown
 H = Horizontal
 V = Vertical



Multiple Weir MW1008A

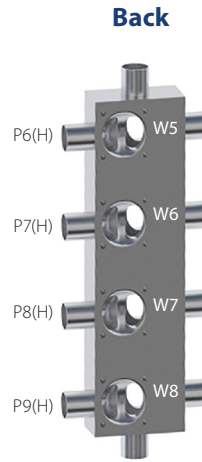
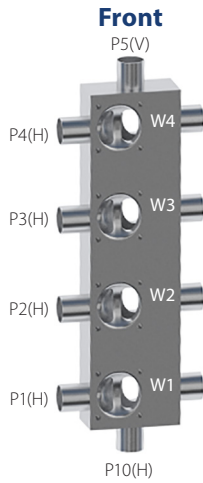

Valve	DN Size	
W1		
W2		
W3		
W4		
W5		
W6		
W7		
W8		
Port	DN Size	Tube Specification
P1		
P2		
P3		
P4		
P5		
P6		
P7		
P8		
P9		
P10		

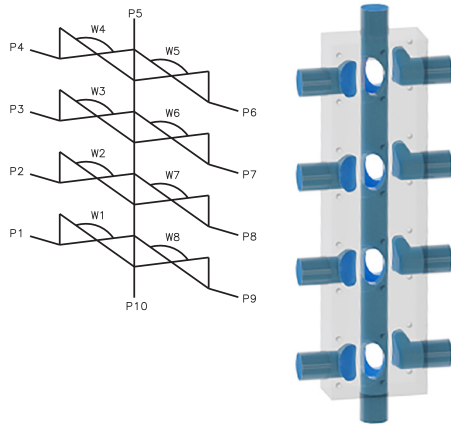

Installation as shown
H = Horizontal
V = Vertical



Multiple Weir MW1008B

Front

P5(V)

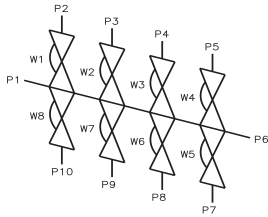
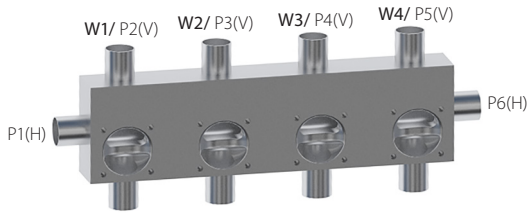

Back

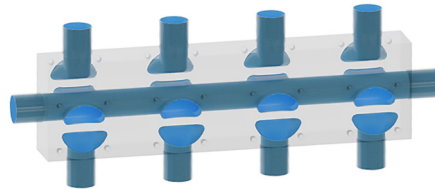
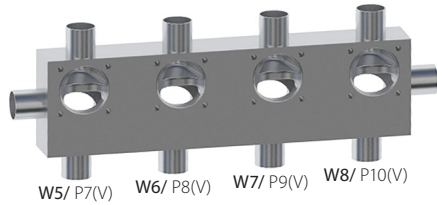

Valve	DN Size	
W1		
W2		
W3		
W4		
W5		
W6		
W7		
W8		
Port	DN Size	Tube Specification
P1		
P2		
P3		
P4		
P5		
P6		
P7		
P8		
P9		
P10		

Installation as shown
H = Horizontal
V = Vertical



Tank Weir TW0201A

Front

Side

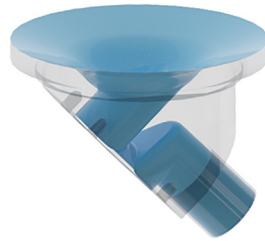
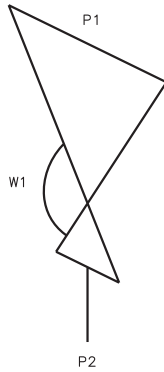
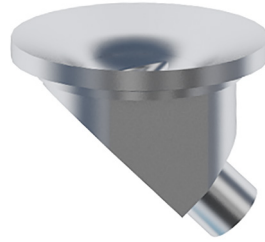
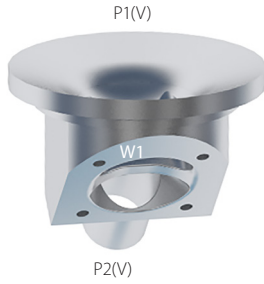

Valve	DN Size	
W1		
Port	DN Size	Tube Specification
P1		
P2		

Installation as shown
H = Horizontal
V = Vertical

Tank Weir TW0201B

Front

Side

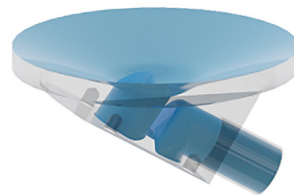
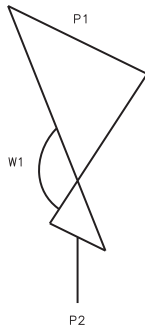
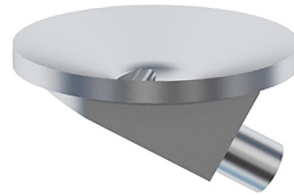
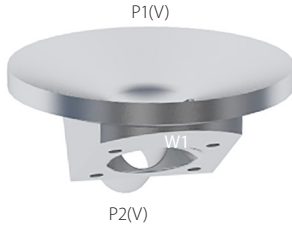

Valve	DN Size	
W1		
Port	DN Size	Tube Specification
P1		
P2		

Installation as shown
H = Horizontal
V = Vertical



Tank Weir TW0201C

Front

Side

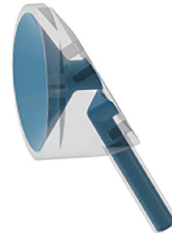
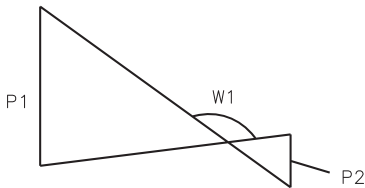

Valve	DN Size	
W1		
Port	DN Size	Tube Specification
P1		
P2		
Tank Clamp Radius		
R1		

Installation as shown
H = Horizontal
V = Vertical



Tank Weir TW0301A

Front

Side

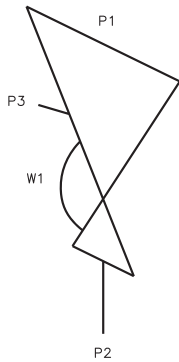
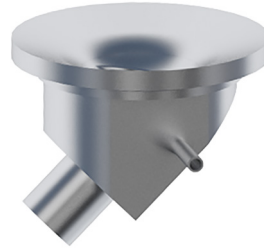
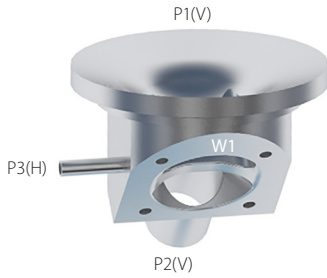

Valve	DN Size	
W1		
Port	DN Size	Tube Specification
P1		
P2		
P3		

Installation as shown
H = Horizontal
V = Vertical



Tank Weir TW0301B

Front

Side

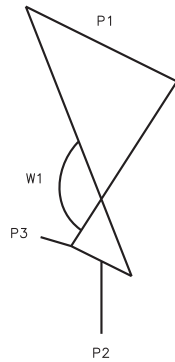
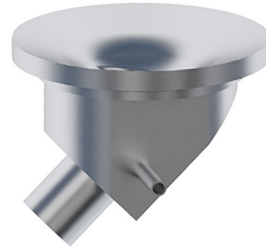
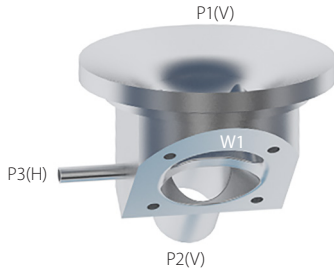

Valve	DN Size	
W1		
Port	DN Size	Tube Specification
P1		
P2		
P3		

Installation as shown
H = Horizontal
V = Vertical

Tank Weir TW0301C

Front

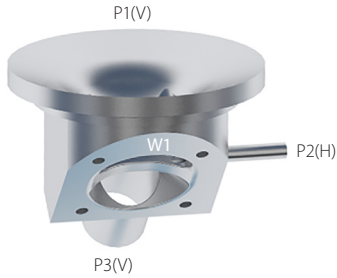

Side

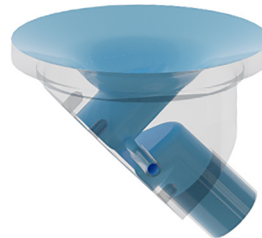
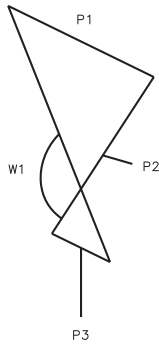
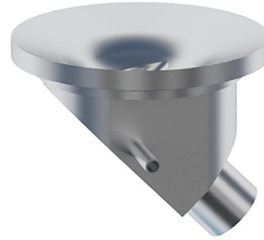

Valve	DN Size	
W1		
Port	DN Size	Tube Specification
P1		
P2		
P3		

Installation as shown
H = Horizontal
V = Vertical



Tank Weir TW0301D

Front

Side

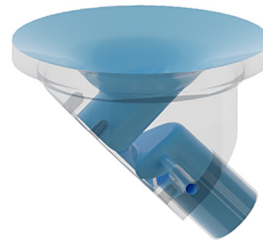
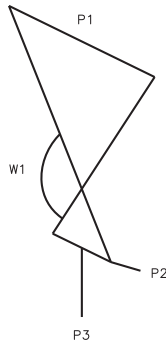
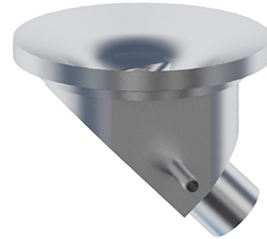
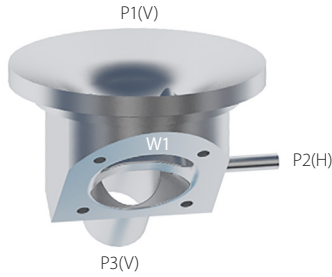

Valve	DN Size	
W1		
Port	DN Size	Tube Specification
P1		
P2		
P3		

Installation as shown
H = Horizontal
V = Vertical



Tank Weir TW0302A

Front

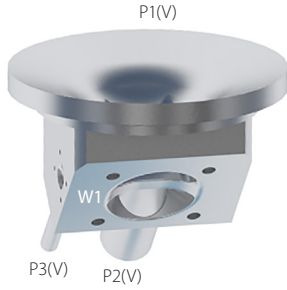

Side

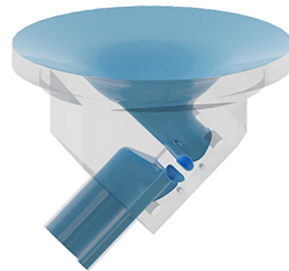
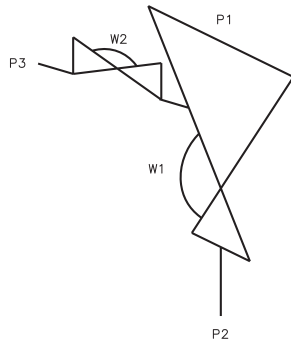

Valve	DN Size	
W1		
W2		
Port	DN Size	Tube Specification
P1		
P2		
P3		

Installation as shown
H = Horizontal
V = Vertical



Tank Weir TW0302B

Front

Side

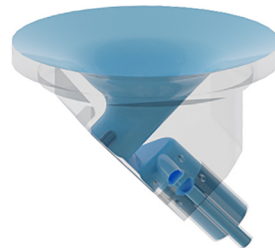
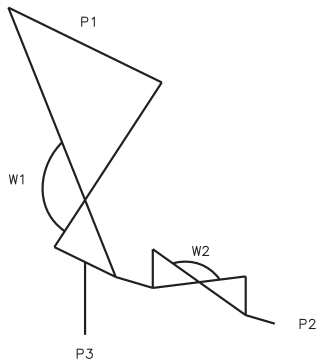
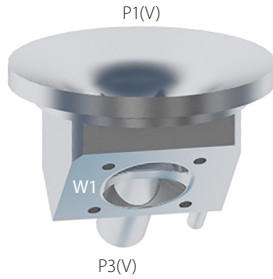

Valve	DN Size	
W1		
W2		
Port	DN Size	Tube Specification
P1		
P2		
P3		

Installation as shown
H = Horizontal
V = Vertical



Tank Weir TW0302C

Front

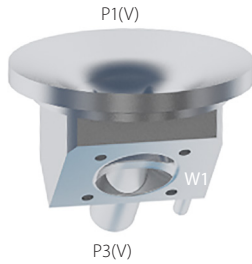

Side

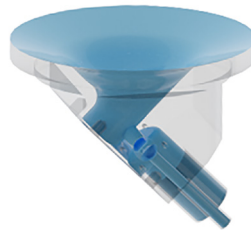
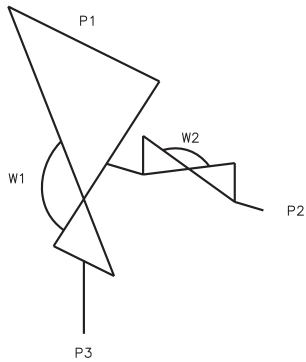
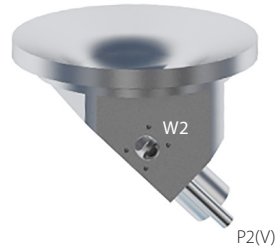

Valve	DN Size	
W1		
W2		
Port	DN Size	Tube Specification
P1		
P2		
P3		

Installation as shown
H = Horizontal
V = Vertical





Tank Weir TW0302D

Front

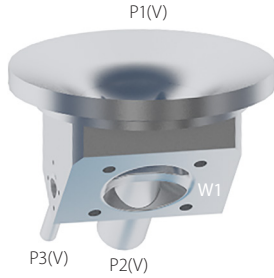

Side

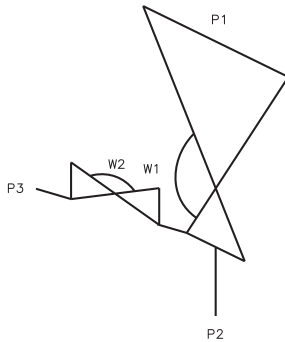

Valve	DN Size	
W1		
W2		
Port	DN Size	Tube Specification
P1		
P2		
P3		

Installation as shown
H = Horizontal
V = Vertical



Tank Weir TW0504A

Front

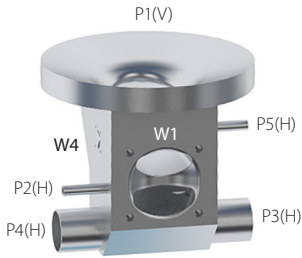

Side

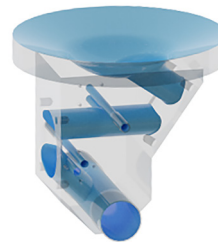
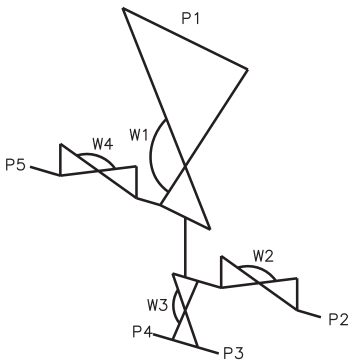
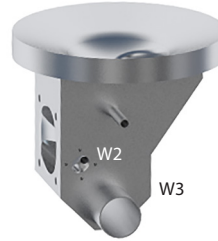

Valve	DN Size	
W1		
W2		
W3		
W4		
Port	DN Size	Tube Specification
P1		
P2		
P3		
P4		
P5		

Installation as shown
H = Horizontal
V = Vertical



Diaphragm Valves Resilience Range Diaphragms

Introduction

Saunders® develops, compounds and manufactures all single piece elastomer and 2 piece leaf style PTFE faced diaphragms in-house from raw ingredient and has front to back ownership of all phases of development and manufacturing.

NEW! Type ER Resilience EPDM Diaphragm

Saunders® ER grade diaphragm is manufactured from a specially formulated EPDM compound. The ER material is peroxide cured for optimum cross linking and to minimize extractables and leachables.

Key Features

1. Enhanced surface finish integrity to assist process purity (ASME BPE compliant)
2. Up to 40% improvement in compression set characteristic compared to typical EPDM diaphragms to reduce need for re-torque and ensure seal to atmosphere
3. Excellent chemical resistance to typical Biopharm process media
4. Front to back technology ownership optimizes security & reliability



The ER diaphragm uses the Saunders® threaded compressor attachment for easy "error free" engagement of diaphragm and compressor.



Type PR PTFE/EPDM Diaphragms

Key Features

1. 100% virgin PTFE product contact face which is inert and unaffected by media common to bio-process applications
2. Industry conforming low levels of extractables and leachables
3. Fabric reinforced EPDM backing



Saunders® SR and PR diaphragms feature the Saunders® bayonet type compressor attachment which allows the diaphragm to float freely relative to compressor to avoid point loading of the TFM at the stud. The bayonet fit also facilitates easy error free engagement of diaphragm and compressor.



PTFE Type Diaphragm

Type SR TFM/EPDM Diaphragms

Key Features

1. Reduction in cold flow deformation typically associated with conventional PTFE components present in BioPharm systems
2. Improved performance under aggressive steam sterilization and pure water-based media
3. Fabric reinforced EPDM backing



Diaphragm Valves Special Diaphragms

Introduction

Through continuous in-house innovation, Saunders team of polymer technologists has developed a range of special diaphragms aimed at solving key application challenges and providing increased TCO (Total Cost of Ownership) to customers in the Life Science Industry.

EX Endurance Diaphragms

Key Features

1. Outstanding high temperature performance and resistance to long term exposure at elevated temperatures
2. Ideal for steam distribution and supply, sterile barrier, and block-and-bleed applications
3. Improved seal-to-atmosphere performance and reduced requirements for re-torquing of fasteners after thermo cycling

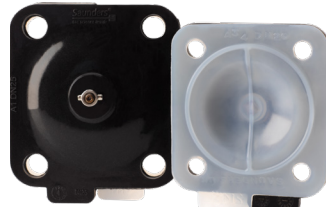

Unique EX Endurance material combination consisting of wetted modified PTFE contact face and fabric reinforced Silicone backing support

Type 500 Grade Silicone Diaphragms

The 500 grade diaphragm uses a dicumyl cured silicone that is fabric reinforced to optimize flex life. This is a white grade of diaphragm which offers very low levels of extractables and leachables. Silicone is ideal for low temperature environments and applications. Like all Life Science Diaphragms, the 500 grade Silicone Diaphragm is FDA conforming and USP Class VI tested and certified.

Saunders full range of Biopharm diaphragms comply with all international test accreditations

- FDA compliant 21CFR
- Third party tested to USP Class VI <87>, <88> Comply with ASME BPE part SG
- Certified ADCF (Animal Derived Component Free)
- Fully lot traceable to EN 10204

Type PV Grade Passivation Diaphragms

The Saunders PV passivation diaphragm has been developed specifically for use during the passivation of stainless steel systems reducing installation and set up costs for the end user.

Key Features

1. Reduced cost versus single use PTFE diaphragm
2. High visibility tag reduces risk of diaphragm not being replaced
3. 100% interchangeable with Saunders Life Science PTFE diaphragm range



PV Passivation Diaphragm



PV Passivation Diaphragm Installed on Valve



Diaphragm Valves Manual Bonnets Overview

Key Features

1. Clean external profile to facilitate wash down and cleaning regimes
2. Suitable materials, corrosion resistant polymer and stainless construction
3. FDA conforming lubricants
4. Compact design easily integrated into process system
5. Autoclavable types for valves subject to repeated autoclaving
6. Modular options including limit open and limit closed stops, padlocking device and switches



PES Performance Bonnet



Para Bonnet



Sealed Stainless Steel Bonnet



Stainless Steel Bonnet

Bonnet Type	Size Range	Shell MOC	Handwheel MOC	Compressor MOC	Autoclavable	SIP	Chemical Resistance
Stainless Steel	DN15 - DN150 (½" - 6")	Stainless Steel	PES (Polyethersulphone)	Stainless Steel	✓	✓	✓
Para	DN15 - DN50 (½" - 2")	PARA (Polyaryl Amide)	PARA (Polyaryl Amide)	Stainless Steel		✓	✓
PES Performance	DN15 - DN80 (½" - 3")	PES (Polyethersulphone)	PES (Polyethersulphone)	Stainless Steel	✓	✓	✓
Stainless Steel Sealed	DN15 - DN80 (½" - 3")	Stainless Steel	Stainless Steel	Stainless Steel	✓	✓	✓
Bioseal Polymer	DN8 (¼")	PPS (Polyphenylene Sulphide)	PPS (Polyphenylene Sulphide)	Stainless Steel	✓	✓	✓
Bioseal Stainless Steel	DN8 (¼")	Stainless Steel	PPS (Polyphenylene Sulphide)	Stainless Steel	✓	✓	✓

Diaphragm Valves Pneumatic Actuator S360



**Saunders® S-360
Compact Actuation**



**M-VUE and I-VUE
Sensors Direct Mount
on S360 Actuator**



**DN100 Compact Tank
Bottom Valve**

Saunders® S360 Lite

The Saunders® S360 Lite range provides standard closure for normally closed applications in a compact, lightweight package and is available through sizes DN8 – DN100 (0.25" – 4.00").

The S360 Lite range is a very compact actuator that offers shutoff performance in line with standard industry applications. The S360 Lite is available in normally closed mode of operation with optimised spring force up to closure to minimize stress on diaphragms. Suitable for 10 bar line pressure (Rubber diaphragm) and 8 bar (PTFE Diaphragm) at 100% delta P.

Saunders® S360 Power

The Saunders® S360 Power range offers higher operating closure performance in a compact package for high operating pressure or atypical closing conditions with high pressure on both sides of the weir. The S360 Power normally closed actuator is available through sizes DN15 – DN50 (0.50" – 2.00").

The Saunders® S360 actuator is also available in normally open and double acting modes. Suitable for 16 bar line pressure at 100% Delta P (both PTFE and Elastomer diaphragm).

Easy Compressor Change

The Saunders® S360 has a unique compressor attachment that permits easy conversion of the compressor between rubber and PTFE diaphragms, minimizing the need to hold two sets of actuators in stock.

Saunders® S360

The S360 is a compact, lightweight, piston-type pneumatic actuator which has been developed to deliver superior performance for sterile BioPharm applications.

Key Features

1. Modular range delivers compact dimensional envelope to reduce dead-leg between associated valves and optimises system design
2. Maintenance free piston technology provides powerful closure performance
3. Smooth corrosion resistant profile optimizes cleanliness



Diaphragm Valves Pneumatic Actuator P345

Pneumatic Actuator P345

Saunders P345 is a compact polymer pneumatic actuator designed to provide superior performance in Bioprocess applications and delivers operational savings in terms of plant efficiency and air consumption.

Key Features

1. 4.5 BAR OPERATING PRESSURE: LOWER TOTAL COST OF OWNERSHIP THROUGH REDUCED AIR CONSUMPTION
2. INDUSTRY LEADING CLOSURE PERFORMANCE: 10 BAR @100% ΔP FOR RUBBER & PTFE DIAPHRAGMS
3. LIGHT WEIGHT CONSTRUCTION: 30% LIGHTER COMPARED TO STAINLESS STEEL VARIANT
4. ZERO MAINTENANCE: MAINTENANCE FREE PLUG-N-PLAY RELIABLE OPERATION



Size Range

- DN8 (0.25") – DN100 (4.00")

Modes of Operation

- Spring-to-Close
- Double Acting

Material of Construction

- Polymer Cover: Polyamide
- Bonnet: Stainless Steel

Temperature

- Max: 100°C
- Min: -10°C

Accessory Options

- Saunders-VUE Sensors (direct mount)
- Limit Open Stop (Spring-to-Close mode)
- Positioners

Diaphragm Interchangeability

- Unique compressor design that permits easy conversion of the compressor between rubber and PTFE Diaphragms

Diaphragm Valves Sensors, Switches & Controls



Saunders-VUE portfolio offers industry leading automation technology that adds intelligence to a diaphragm valve, delivering savings to the customer.

TOTAL COST OF OWNERSHIP
DELIVERS \$1.3M SAVINGS
IN 5 YEARS FOR 2800 SENSOR FACILITY

ZERO MAINTENANCE
CONTACTLESS OPERATION WITHOUT
ANY ROUTINE MAINTENANCE

RELIABLE & ACCURATE
STATE OF THE ART CONTINUOUS
SENSING MAGNETIC TECHNOLOGY

INTELLIGENT
OFFERS REMOTE DIAGNOSTICS TO
OPTIMIZE PREVENTIVE MAINTENANCE

As the inventor of the diaphragm valve, Saunders[®] has been a key player in the evolution of high purity valve technology. Continuing the lead in aseptic valve technology, Saunders[®] has engineered a suite of automation products that add intelligence to a diaphragm valve offering new possibilities to our customers.

Saunders-VUE offers intelligent solutions for diaphragm valves in the Life Science Industry. Saunders-VUE platform is designed to maximize plant efficiency by eliminating false alarms and reducing set-up times. Saunders-VUE valve sensors provide a wide variety of diagnostic features that help in continuous monitoring and preventative maintenance. All the unique features can be operated remotely over an industrial network or locally using a magnetic key to extract diagnostics and facilitate safe, secure and efficient processing and maintenance.

Saunders-VUE range of valve sensors are designed to provide positive and accurate confirmation of valve position while delivering a wide variety of diagnostics to enable continuous monitoring and preventative maintenance.

- Saunders-VUE Sensors are contactless and operated either by a magnetic key or remotely through an industrial network.
- Focused on delivering valve intelligence, Saunders-VUE sensors offer millions of dollars of savings to the customer throughout the lifetime of the sensor.
- Saunders-VUE sensors are available in point-to-point (P2P), AS-i and DeviceNet versions.
- \$1.3 million in savings over approximately five years for a 2800 sensor facility.

Saunders-VUE automation solution adds intelligence to a diaphragm valve!



Diaphragm Valves Sensors, Switches & Controls

Saunders-VUE sensors maximize plant efficiency by increasing accuracy and eliminating false alarms.

The innovative self-calibration feature allows the sensor to identify open and close valve positions without opening the enclosure.

Assumptions

- A switchbox is calibrated every time a diaphragm is changed.
- Labor rate is \$100 per hour.
- Diaphragm change-outs are performed once a year.

Saving Time Per Calibration

- Saunders-VUE sensors can be calibrated by one person in under 3 minutes, while a traditional switchbox is calibrated by two people in 30 minutes.

Pre-Commissioning

- In pre-commissioning, a valve is calibrated four times: during Factory Acceptance Test (FAT), passivation, start-up and pre-calibration.

Based on model assumptions:

- One Saunders-VUE sensor saves \$45 per calibration.
- Overall pre-commissioning savings is \$180 per sensor.
- Saunders-VUE sensors can be calibrated by one person in under 3 minutes, while a traditional switchbox is calibrated by two people in 30 minutes.

Post-Commissioning

- In post-commissioning, a valve is calibrated two times: during routine maintenance and diaphragm change-outs.

Based on model assumptions:

- One Saunders-VUE sensor saves \$95 per calibration.

A 2800 valve facility can save \$1.3 million in 5 years

Payback time for Saunders-VUE Sensors is only four diaphragm change-outs

SAUNDERS-VUE SENSORS

Save your facility \$1.3 million in five years*



Saunders-VUE Sensors

vs.



Traditional Switchbox

REQUIREMENTS PER CALIBRATION

TECHNICIANS



One



Two

MINUTES



Three



Thirty

Saunders-VUE sensors require half of the manpower and a tenth of time per calibration.

PRE-COMMISSIONING

In pre-commissioning, a sensor is calibrated **FOUR** times:
✓
+
+
+
+

COST PER CALIBRATION

\$5.00

\$50.00

Saunders-VUE Sensors deliver 90% savings in pre-commissioning!

POST-COMMISSIONING

In post-commissioning, a sensor is calibrated **TWO** times:
+
+

COST PER CALIBRATION

\$5.00

\$100.00

Saunders-VUE Sensors deliver 95% savings in post-commissioning!

Payback time = **FOUR** diaphragm changeouts



*Based on the assumption that a switchbox is calibrated every time a diaphragm is changed and labor rate is \$100 per hour. **For a facility consisting of 2800 diaphragm valves with scheduled replacing diaphragms once a year.

www.cranecpe.com

Crane ChemPharma & Energy

155

CPE-SAUNDERS-BIO_BLOCK_MANUAL-BU-EN-A5-2023_11_28.indd

11/28/2023 10:08:44 AM



Crane ChemPharma & Energy
 Crane Process Flow Technologies Ltd.
 Grange Road
 Cwmbran, Gwent NP44 3XX
 UNITED KINGDOM
 Tel: +44 163 348 6666
 Fax: +44 163 348 6777
 www.cranecpe.com

CRANE

Crane Process Flow
 Technologies SPRL / BV
 Avenue Franklin No. 1
 Wavre, B-1300 , Belgium
 Tel: +32 10 8184 44
 Fax: +32 10 8184 58

Crane Process Flow
 Technologies (India) Ltd
 Solitaire, 5th & 6th Floor, S.No. 131 / 1+2,
 ITI Road, Aundh, Pune - 411007, India
 Tel: +91 20 3056 7800
 Fax:+91 20 3056 7812

Saunders® Sales Office
 9860 Johnson Road
 Montgomery, Texas 77316
 Tel: +1 936 588 8360
 Fax: +1 936 588 8302

brands you trust.



Crane Co., and its subsidiaries cannot accept responsibility for possible errors in catalogues, brochures, other printed materials, and website information. Crane Co. reserves the right to alter its products without notice, including products already on order provided that such alteration can be made without changes being necessary in specifications already agreed. All trademarks in this material are property of the Crane Co. or its subsidiaries. The Crane and Crane brands logotype, in alphabetical order, (ALOYCO®, CENTER LINE®, COMPAC-NOZ®, CRANE®, DEPA®, DUO-CHEK®, ELRO®, FLOWSEAL®, JENKINS®, KROMBACH®, NOZ-CHEK®, PACIFIC VALVES®, RESISTOFLEX®, REVO®, SAUNDERS®, STOCKHAM®, UNI-CHEK®, WESTLOCK CONTROLS®, WTA®, and XOMOX®) are registered trademarks of Crane Co. All rights reserved.

© Crane ChemPharma & Energy

CPE-SAUNDERS-BIO_BLOCK_MANUAL-BU-EN-A5-2023_11_28