

ResistoPure™

brands you trust.



Design Manual



Crane ChemPharma & Energy

www.cranecpe.com

Overview

Flanged Plastic-Lined Pipe

CRANE ChemPharma, Resistoflex plastic-lined pipe is made with a locked-in liner to minimize the adverse effects of differential thermal expansion between the liner and the steel.

Available liners are: PP, Kynar® PVDF, and Teflon® PTFE or PFA.



Plastic-Lined Fittings

PP, Kynar® PVDF, and Teflon® PFA fittings are all injection or transfer molded. TEFZEL® lined fittings and special shapes are roto-lined in custom housings. Teflon® PTFE liners are made by isostatic molding.



Special Shapes

- Custom fittings, manifolds, and small vessels
- Lined with TEFZEL® ETFE
- Available through 24" diameter

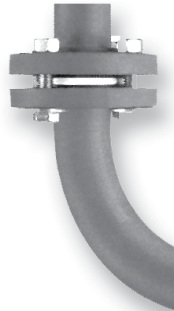

Thermalok Pipe

- Stress relieved liner
- Unlimited housing material options
- Sizes ranging from 1" - 24" diameter

Swaged Pipe

- Used exclusively for CONQUEST® and MULTI-AXIS®
- Sizes ranging from 1" - 8"
- Threaded flanges and threaded rotatable flange assemblies only



CONQUEST® Connections

- Patented flangeless joint design
- Performance of a welded system
- Available in 1" - 4" for all liner types
- Virtually zero maintenance



- High-Purity Silicone Hoses
- High-Purity Teflon® Hoses
- Clean-Room Assembly Packaging
- Virtually zero maintenance



Expansion Joints of TEFLON®

- 2, 3, or 5 Convolute construction
- Bolt or cable limited
- Teflon® T-62 for maximum flex life
- 1" - 24" Size range
- DI or SS Flanges available

Table of Contents

Smooth Bore Teflon® Hoses	STRATUS™ Hose.....	4 - 5
	Cirrus™ HP Hose.....	6
	TRC-Teflon® Smooth Bore Rubber Covered Hoses.....	7
	TRC FLARED THRU Hose.....	8
Silicone and Other Hoses	Si-B HD and Si Braid-Reinforced Silicone Hose	9
	Si-W Fabric-Reinforced Silicone Hose	10
	Si-V Silicone Suction Hose.....	11
	Other Teflon® Hoses	12 - 13
Fittings and Accessories	Fittings.....	14 - 19
	Adapters and Accessories	20
Technical Data & Part Number System	Features Comparison Chart.....	21
	ResistoPure™ Quality Assurance.....	22
	Teflon® in High Purity Applications.....	23
	Definitions, Installation, and Motion Considerations.....	24
	Steam and Temperature Conversion Chart.....	25
	Part Number System	26 - 27

Teflon® PTFE-Lined Silicone Hose

STRATUS™

Teflon® PTFE-Lined Silicone Hose*

* Patent Pending



Teflon® is a trademark of CHEMOURS FC. Only CHEMOURS FC makes Teflon®. Kynar® is a trademark of Arkema, Inc.

Approved Materials Throughout —

- USP Class VI <88>
- USP MEM Elution <87>
- 21 CFR 177.1550 (Teflon®)
- 21 CFR 177.2600 (Silicone)
- ISO 10993 (Silicone)

Features —

- FLARED THRU Design - Zero Entrapment
- Excellent Drainability - Better Product Recovery
- Extended Life Cycle - Reduced Ownership cost
- One Wetted Part (Teflon®) - Universal SIP, CIP and Product Compatibility

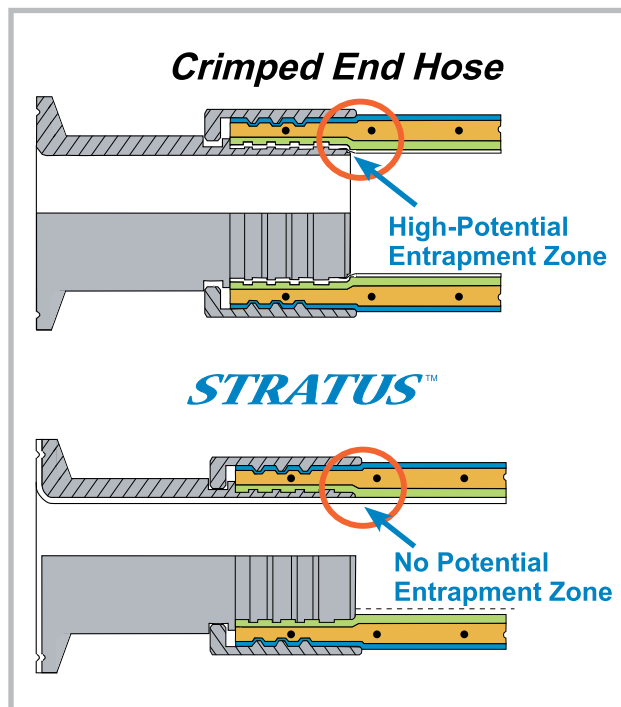

STRATUS™ General Hose Data

Size (in.)	Actual I.D. (in.)	O.D. (in.)	Hose Working Pressure (70 °F - 280 °F)	Fitting Working Pressure (70 °F - 280 °F)	Vacuum Rating (70 °F - 280 °F)	Minimum Bend Radius (in.)	Force to Bend (lbs.*)
1/2	0.370	0.895	475 psig	200 psig	Full	2.375	6.0
3/4	0.620	1.145	450 psig	200 psig	Full	2.937	7.0
1	0.870	1.410	425 psig	200 psig	Full	4.156	9.5
1 1/2	1.370	1.895	400 psig	200 psig	Full	7.062	10.0
2	1.870	2.395	350 psig	200 psig	Full	11.812	8.7

* Hose bent 90° over a mandrel at the minimum bend radius

Key Comparisons Hidden Contamination

Silicone Hose 1
Crimped End



Silicone Hose 2
Crimped End



PTFE-Lined
Rubber-Covered Hose
Crimped End



STRATUS™
Teflon® PTFE-Lined
Silicone Hose



Could your crimped fitting hose be a source of contamination?

1" dia. x 24" long hoses were tested per ASTM F1545 steam/cold water cycling. After the steam/cold water test, the hoses were filled with a riboflavin/water mixture, pressurized, and drained. These photographs, taken under UV light, show the amounts of riboflavin that remained trapped underneath the crimped fitting area that cannot be sterilized.

RESIDUAL PRODUCT AFTER DRAINING

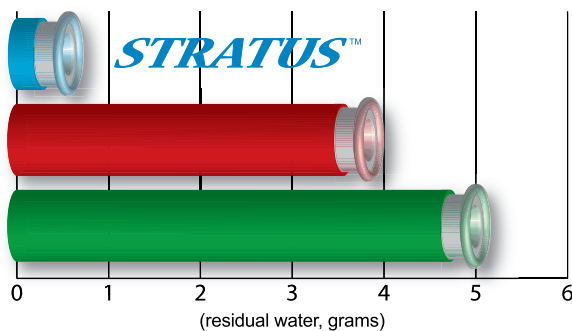

How much product remains in your crimped fitting hose?

1" dia. x 24" long hoses with hygienic clamp fittings were filled with water and then drained at a 0.6 degree slope angle. Stratus had the least amount of liquid remaining inside the hose.



LIFE CYCLE COST COMPARISON

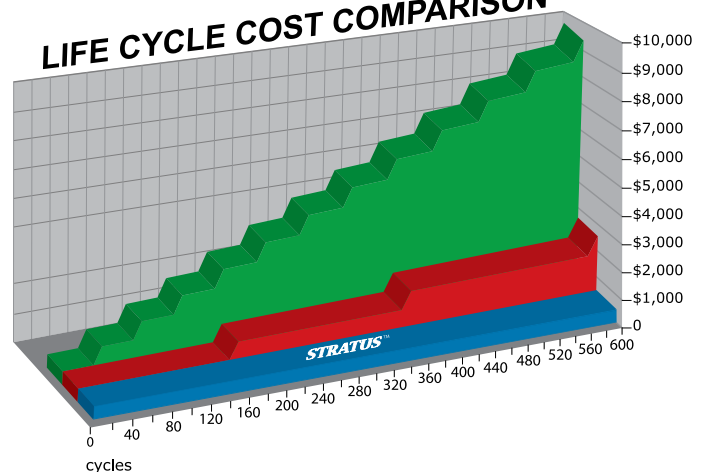

STEAM SANITATION CYCLING

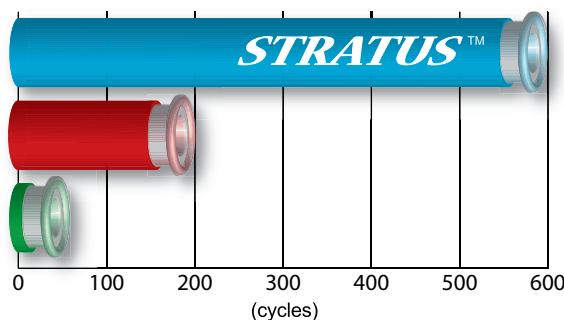

What life do you expect from your crimped fitting hose?

1" dia. x 24" long hoses were tested per ASTM F1545 steam/cold water cycling. Stratus hose never leaked under these conditions, and was still performing long after the others failed.

How much are your crimped fitting hoses costing you?

Life cycle data based on steam testing per ASTM F1545 steam/cold water cycling shows Stratus performing with the longest life of the three competing hoses. Each "step" on the graph is a replaced hose. The dollar values were calculated by adding the market price of a representative hose and \$500 per changeout for work order and labor costs. At the time this brochure was printed, Stratus reached 600 cycles without failure and was still running.

Cirrus™ - Teflon® Smooth Bore EPDM Rubber Covered Hose

Inner core: Smooth *Teflon*® PTFE
Reinforcement: EPDM rubber

Construction

Natural smooth bore *Teflon*® PTFE liner bonded to a cover reinforced with multiple nylon plicord and gray EPDM rubber. Cover is shiny and cleanable. A double-helix high tensile strength wire embedded in the carcass provides crush, kink, and vacuum resistance.

Benefits

- *Teflon*® PTFE liner acceptable per FDA CFR 177.1550 and USP 28, NF 23, 2005 for Class VI plastics
- USP Class VI Approval
- USP L929 MEM Elution
- Will not absorb media
- Low minimum bend radius and force-to-bend
- Long service life
- Meets or exceeds common working conditions in BioPharm industries
 - > Steam Cleaning
 - > Autoclaving
 - > CIP
 - > SIP
- Full vacuum-rated
- Lot-traceable documentation

Fittings

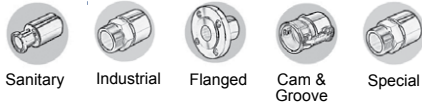

Fitting Material Availability

316L S.S.
 Teflon® Encapsulated

External Protective Accessories

Spiral guards, kink guards, and shrink sleeves available.



Cirrus™ HOSE PRESSURE RATINGS

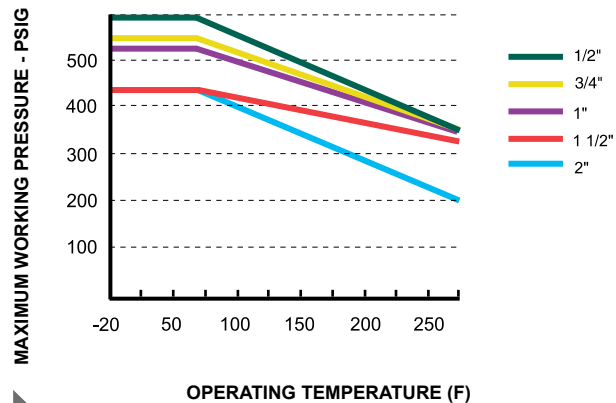

NOTE: For assemblies, pressure ratings of fittings may be less than for the hose.

Cirrus™ HOSE VACUUM RATINGS

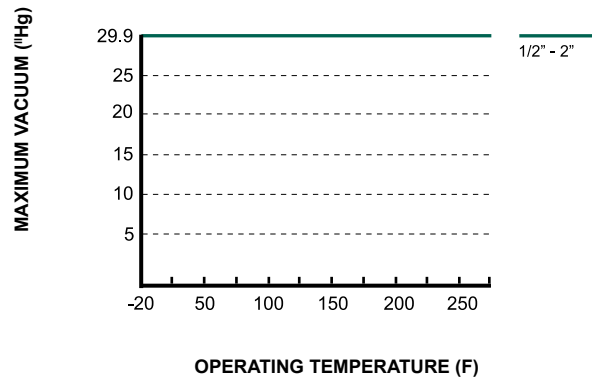

Note: Vacuum ratings are based on testing of straight assemblies. Bent assemblies may have reduced vacuum resistance.

Size		Hose I.D.		Overall Wall Thickness		Max. Working Pressure at 70°F (21°C)		Burst Pressure at 70°F (21°C)		Approximate Weight		Bend Radius	
INCH	DN	INCH	MM	INCH	MM	PSIG	BAR	PSIG	BAR	LBS./FT.	KG/M	INCH	MM
1/2	15	0.525	14	0.213	6	600	42	2400	166	0.39	0.59	1.75	45
3/4	20	0.775	20	0.239	7	550	38	2200	152	0.56	0.84	2.5	64
1	25	1.030	27	0.232	6	530	37	2120	147	0.73	1.09	3.38	86
1-1/2	40	1.525	39	0.310	8	430	30	1720	119	1.32	1.97	5.5	140
2	50	2.025	52	0.326	9	430	30	1720	119	1.81	2.7	8	204

TRC - Teflon® Smooth Bore EPDM Rubber Covered Hose



Inner core: Smooth Teflon® PTFE 1/2" - 2"
Smooth Teflon® FEP 3" - 4"
Reinforcement: EPDM rubber
Temperature: -20 °F to 300 °F

Construction

Smooth bore Teflon® liner bonded to a cover reinforced with multiple nylon plicord and EPDM rubber. A double-helix high tensile strength wire embedded in the shell provides crush, kink and vacuum resistance.

Benefits

- Robust construction delivers extended service life, especially in steam cycling situations, compared to hoses of similar construction and appearance
- Smooth, flexible Teflon® liner for use in a wide range of applications and ease of cleaning
- Outstanding flexibility, bend-ability and bend radius
- Durable, kink-resistant EPDM reinforced design for extended life and easy handling
- PTFE available with natural or conductive liner

Applications

- Chemical, food, beverage, pharmaceutical and other process transfers
- Rail car and trailer loading/unloading
- Load cell applications
- Chemical cleaning and/or steam cleaning/sterilizing applications

Fittings: Crimp Style

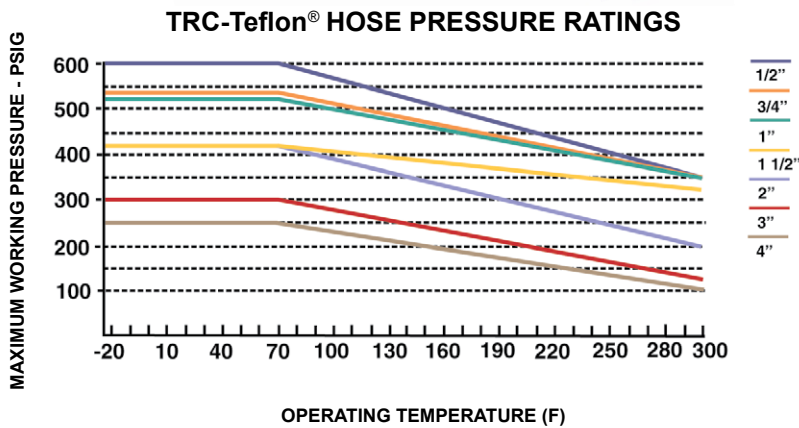
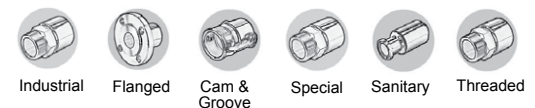

NOTE: Hose assembly pressure ratings may be limited by the fittings.

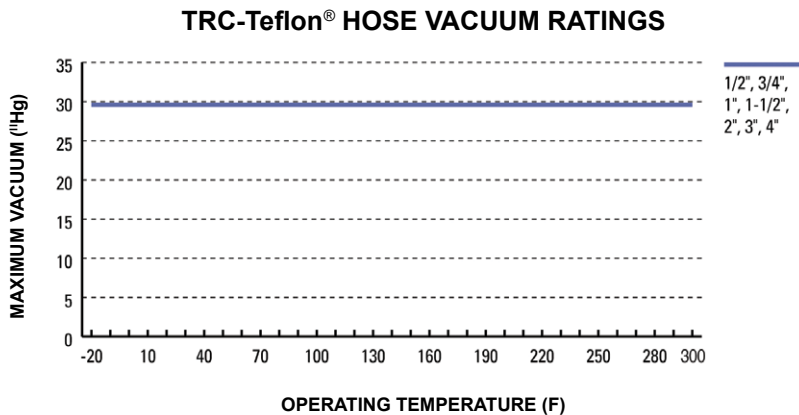

NOTE: Custom colors available upon request. Consult factory.

	Nominal Size		Hose ID		Hose OD		Bend Radius		Max. Working Pressure at 70°F (21°C)		Burst Pressure at 70°F (21°C)		Weight Lbs / Ft
	INCH	DN	INCH	MM	INCH	MM	INCH	MM	PSIG	BAR	PSIG	BAR	
PTFE	1/2	15	0.525	13.3	0.997	25.3	1.75	44.5	600	41.3	2400	165.4	.46
	3/4	20	0.775	19.7	1.299	33.0	2.5	63.5	550	37.9	2200	151.6	.56
	1	25	1.03	26.2	1.54	39.1	3.38	85.9	530	36.5	2120	146.1	.79
	1-1/2	40	1.525	38.7	2.191	55.7	5.5	139.7	430	29.6	1720	118.5	1.22
	2	50	2.025	51.4	2.723	69.2	8	203.2	430	29.6	1720	118.5	1.84
FEP	3	80	3.015	76.6	3.812	96.8	24	711.2	300	20.7	1200	82.7	0.80
	4	100	4.010	101.9	4.937	125.4	42	1066.8	250	17.2	1000	68.9	5.15

TRC FLARED THRU Hose

Inner core: Smooth *Teflon*® PTFE
Reinforcement: EPDM rubber

Construction

Extra-thick, natural or conductive smooth bore *Teflon*® PTFE liner secured (without bonding agents) to a reinforced EPDM rubber cover. A carbon steel wire helically wound through the carcass provides crush, kink and vacuum resistance. Liner is flared out over the face of the fitting.

Benefits

- USP Class VI approval
- USP MEM Elution <87>
- Unique FLARED THRU design (patent pending)
- Unique Thermalok™ process Results in interference fit liner
- No entrapment issues
- True sanitary I.D. dimensions
- Wide variety of fittings available
- Full vacuum-rated
- *Teflon*® PTFE liner acceptable per FDA CFR 177.1550 and USP 28, NSF 23, 2005 for Class VI plastics

Fittings

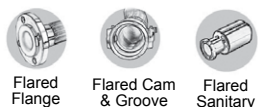

Fitting Materials

316L S.S.

External Protective Accessories

Spiral guards, kink guards, and shrink sleeves available.

Custom colors available upon request. Minimum order quantity applies.



TRC FLARED-THRU HOSE PRESSURE RATINGS

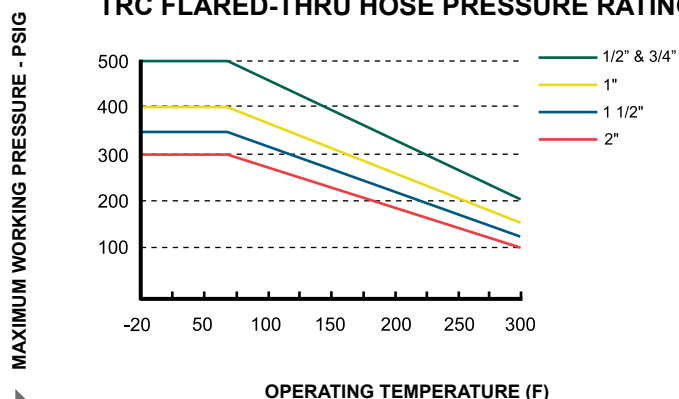

NOTE: For assemblies, pressure ratings of fittings may be less than for the hose.

TRC FLARED-THRU HOSE VACUUM RATINGS

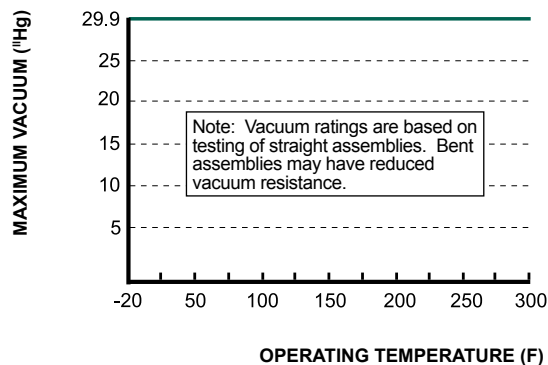

Size		Hose I.D.		Hose O.D.		Min Bend Radius		Max. Working Pressure at 70°F (21°C)		Burst Pressure at 70°F (21°C)	
Inch	DN	Inch	MM	Inch	MM	Inch	MM	PSIG	BAR	PSIG	BAR
1/2	15	0.750	19.05	1.30	33	3	76.2	500	34.5	2000	137.8
3/4	20	0.750	19.05	1.30	33	3	76.2	500	34.5	2000	137.8
1	25	1.000	25	1.56	39.6	4	101.6	400	27.6	1600	110.3
1-1/2	40	1.500	38.1	2.05	52	12	304.8	350	24.1	1400	96.5
2	50	2.000	51	2.56	65	12	304.8	300	20.7	1200	82.8

Si-B HD Reinforced Silicone Hose and Si-B Braid Reinforced Silicone Hose

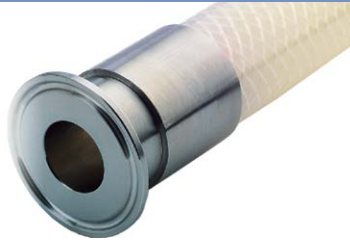

Si-B HD HOSE PRESSURE RATINGS
OPERATING TEMPERATURE (F)

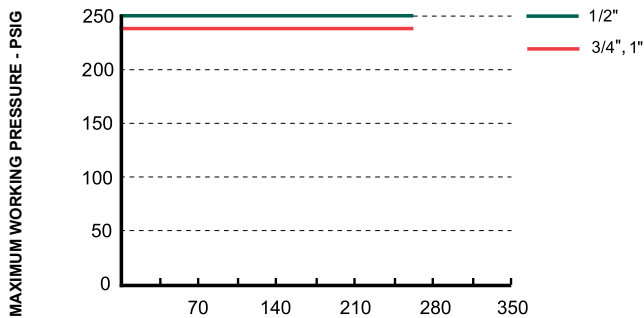

NOTE: For assemblies, pressure ratings of fittings may be less than for the hose.

Nominal I.D.		Wall Thickness		Hose O.D.		Max. Working Pressure at 70°F (21°C)		Burst Pressure at 70°F (21°C)		Approximate Weight	
Inch	DN	Inch	MM	Inch	MM	PSIG	BAR	PSIG	BAR	LBS./FT.	KG/M
1/2	15	.220	5.6	.940	23.9	250	17.2	1000	68.9	.19	.28
3/4	20	.250	6.4	1.250	31.8	250	17.2	1000	68.9	.41	.61
1	25	.230	5.8	1.470	37.3	240	16.5	960	66.2	.88	1.31

NOTE: Bulk tubing available in 25 ft., 50 ft., or 100 ft. coils.

Si-B Braid HOSE PRESSURE RATINGS
OPERATING TEMPERATURE (F)

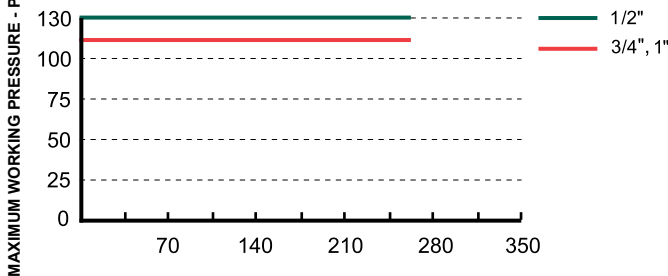

NOTE: For assemblies, pressure ratings of fittings may be less than for the hose.

Nominal I.D.		Wall Thickness		Hose O.D.		Min. Bend Radius		Max. Working Pressure at 70°F (21°C)		Burst Pressure at 70°F (21°C)		Approximate Weight	
Inch	DN	Inch	MM	Inch	MM	Inch	MM	PSIG	BAR	PSIG	BAR	LBS./FT.	KG/M
1/2	15	.150	3.8	.80	20.3	2	50.8	130	8.9	520	35.8	.16	.24
3/4	20	.175	4.5	1.10	27.9	3	76.2	110	7.5	440	30.3	.26	.39
1	25	.180	4.6	1.36	34.5	4	101.6	110	7.5	440	30.3	.35	.52

NOTE: Bulk tubing available in 25 ft., 50 ft., or 100 ft. coils. 1/8", 1/4", 3/8", and 1 1/4" sizes available - Consult factory

- Platinum-Cured Silicone
- Polyester Braid
- High Pressure
- Extremely Flexible

Benefits

- Suitable for pharmaceutical, biomedical, cosmetic and food applications
- -50 °F – 350 °F temperature range
- Sterilizable/Autoclavable
- 65A Shore hardness
- Documented lot traceable
- Available in custom lengths and color coding
- Factory assembly and packaging in a Class 10,000 Clean Room available

Approvals

- USP Class VI

Meets or Exceeds:

- FDA CFR 177.2600
- USDA and 3A Standards
- ISO 10993
- European Pharmacopoeia 3.1.9

Fittings

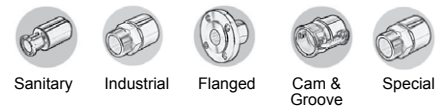

Fitting Material Availability

316L S.S.
Teflon® Encapsulated

Si-W Fabric-Reinforced Silicone Hose

- Low Volatile Grade Platinum-Cured Silicone
- Multi-Ply Polyester Fabric Reinforcement
- High Pressure

■ Benefits

- Suitable for pharmaceutical, biomedical, cosmetic and food applications
- -50 °F – 350 °F temperature range
- Sterilizable/Autoclavable
- 50A Shore hardness
- Documented lot traceable
- Available in custom lengths (up to 24 feet) and color coding
- Factory assembly and packaging in a Class 10,000 Clean Room available

■ Approvals

- USP Class VI

■ Meets or Exceeds:

- FDA CFR 177.2600
- USDA and 3A Standards
- ISO 10993
- European Pharmacopoeia 3.1.9

■ Fittings

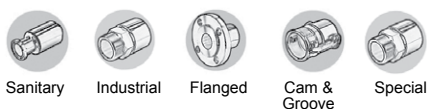

■ Fitting Material Availability

316L S.S.
Teflon® Encapsulated

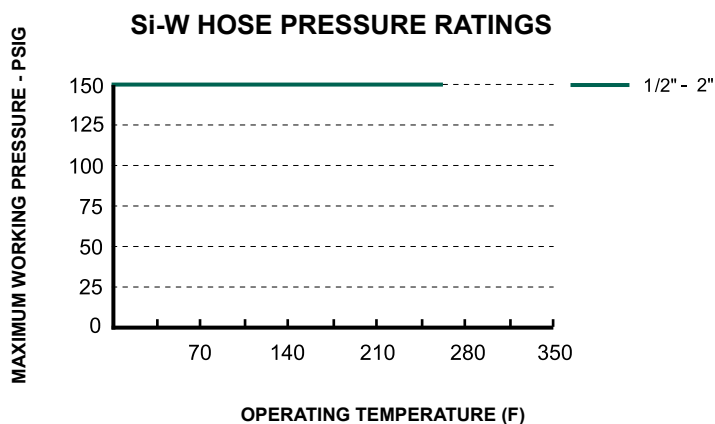

▶ **NOTE:** For assemblies, pressure ratings of fittings may be less than for the hose.

Nominal I.D.		Wall Thickness		Hose O.D.		Min. Bend Radius		Max. Working Pressure at 70°F (21°C)		Burst Pressure at 70°F (21°C)		Approximate Weight	
Inch	DN	Inch	MM	Inch	MM	Inch	MM	PSIG	BAR	PSIG	BAR	LBS./FT.	KG/M
1/2	15	.180	4.6	0.834	21.2	3	76.2	150	10.3	600	41.3	.30	.45
3/4	20	.200	5.1	1.16	29.4	5	127	150	10.3	600	41.3	.39	.58
1	25	.200	5.1	1.39	35.3	9	228.6	150	10.3	600	41.3	.43	.60
1-1/2	40	.200	5.1	1.90	48.8	12	304.8	150	10.3	600	41.3	.72	1.07
2	50	.200	5.1	2.38	60.5	30	762	150	10.3	600	41.3	1.08	1.61

Si-V Silicone Suction Hose



- Low Volatile Grade Platinum-Cured Silicone
- 4-Ply Polyester Braid, SS Wire Reinforced
- Rated for Full Vacuum
- **Benefits**
 - Suitable for pharmaceutical, biomedical, cosmetic and food applications
 - -50 °F – 350 °F temperature range
 - Rated for full vacuum to 300°F
 - Sterilizable/Autoclavable
 - 50A Shore Hardness
 - Documented lot traceable
 - Available in custom lengths (up to 24 feet) and color coding
 - Factory assembly and packaging in a Class 10,000 Clean Room available

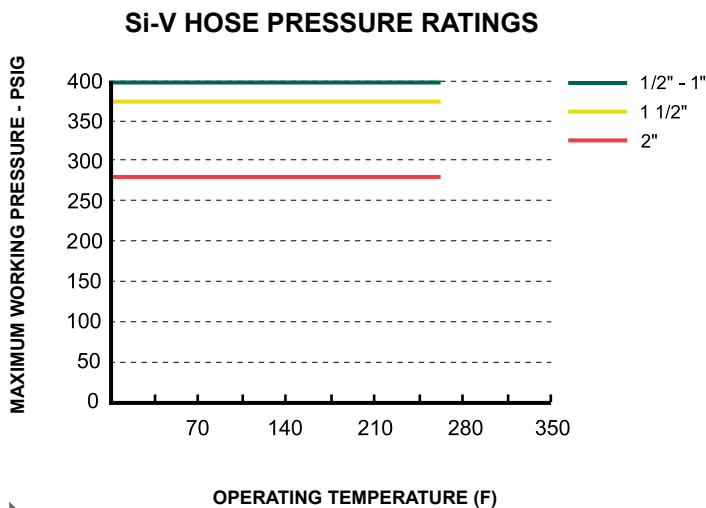

NOTE: For assemblies, pressure ratings of fittings may be less than for the hose.

- **Approvals**
 - USP Class VI
 - USP MEM Elution <87> on all parts
- **Meets or Exceeds:**
 - FDA CFR 177.2600
 - USDA and 3A Standards
 - ISO 10993
 - European Pharmacopoeia 3.1.9

■ **Fittings**



■ **Fitting Material Availability**

316L S.S.
Teflon® Encapsulated

Nominal I.D.		Wall Thickness		Hose O.D.		Min. Bend Radius		Max. Working Pressure at 70°F (21°C)		Burst Pressure at 70°F (21°C)		Vacuum Rating at 300°F (149°C)		Approximate Weight	
Inch	MM	Inch	MM	Inch	MM	Inch	MM	PSIG	Bar	PSIG	Bar	Inches Hg	Bar (a)	LBS./FT.	KG/M
1/2	15	.180	4.6	0.890	22.6	3	76.2	400	27.6	1600	110.3	29.9	0	.30	.45
3/4	20	.200	5.1	1.19	30.3	5	127	400	27.6	1600	110.3	29.9	0	.39	.58
1	25	.200	5.1	1.39	35.3	7	177.8	400	27.6	1600	110.3	29.9	0	.43	.60
1-1/2	40	.200	5.1	1.89	48	9	228.6	375	25.8	1500	103.4	29.9	0	.72	1.07
2	50	.200	5.1	2.39	60.7	11	279.4	275	18.9	1100	75.8	29.9	0	1.08	1.61

NOTE: 1 1/4", 2 1/2", 3", and 4" sizes available - Consult factory
www.cranecpe.com

Other Teflon® Hoses

SBT and SBTF Stainless Steel Braided Hose

Inner core: Smooth *Teflon*® PTFE
Reinforcement: 300-series stainless steel braid



■ Construction

Extra-thick, natural or conductive smooth bore *Teflon*® PTFE liner braided with 300-series stainless steel heavy gauge wire (1" and 1-1/2" are double-braided for extra kink resistance).

■ Benefits

- Provides higher working temperatures and full vacuum capabilities
- Heavy gauge stainless steel braid is corrosion resistant against most chemicals
- Flanged assemblies can be "FLARED THRU" providing no bacteria traps
- Available in long lengths
- "True ID," for superior flow characteristics and easy dimensional matchup

■ Fittings

- Sanitary
- Cam and Groove
- Std. and flared Flange
- Threaded

CB and CBF Stainless Steel Braided Hose

Inner core: "Seamless" convoluted *Teflon*® PTFE
Reinforcement: 316 stainless steel braid (Hastelloy® and custom braids available)



■ Construction

Extra-thick natural or conductive "seamless" helical convoluted *Teflon*® PTFE liner braided with 316 stainless steel heavy gauge wire.

■ Benefits

- Open-pitched, helical convolutions for easy cleaning
- Rated for both medium pressure and full vacuum applications
- Crush resistant and easy to flex
- Tighter bend radii than smooth bore
- Optional external wire provides increased crush resistance

■ Fittings

- Std. and flared sanitary
- Std. and flared Cam and Groove
- Std. and flared Flange
- Threaded

CPB and CPBF Polypropylene Braided Hose

Inner core: "Seamless" convoluted *Teflon*® PTFE
Reinforcement: Blue polypropylene, UV-stabilized braid



■ Construction

Extra-thick natural or conductive "seamless" helical convoluted *Teflon*® PTFE liner braided with thick, high density, polypropylene braid.

■ Benefits

- Open-pitched, helical convolutions for easy cleaning
- Rated for both medium pressure and full vacuum applications
- Crush resistant and easy to flex
- Tighter bend radii than smooth bore alternatives
- Abrasion resistant braid
- Reduced risk of hand injury from metal braids
- Optional external wire provides increased crush resistance.

■ Fittings

- Std. and flared sanitary
- Std. and flared Cam and Groove
- Std. and flared Flange
- Threaded

Other Teflon® Hoses - Design Data

Hose	Size (NPS)	I.D. (in.)	O.D. (in.)	Bend Radius (in.)	Max. Working Pressure (psig)		Vacuum Rating (in. Hg.)	
					70 F	350 F	70 F	350 F
SBT	1/4	0.250	.375	3	3000	CF	CF	CF
	3/8	0.375	.515	5	2000			
	1/2	0.500	0.633	6.5	1425			
	3/4	0.750	0.875	8.5	1000			
	1	1.000	1.190	12	1000			
	1 1/2	1.500	1.762	18	1000			
SBTF	3/4	0.750	.875	8.5	275	215	CF	CF
	1	1.000	1.190	12	275	215		
	1 1/2	1.500	1.762	14	275	215		
CB	1/2	0.470	0.748	2	1425	1050	Full	Full
	3/4	0.720	1.048	2.75	1300	1000		--
	1	0.970	1.354	4	1100	825		10
	1 1/2	1.540	2.034	6	700	525		5
	2	1.970	2.464	7.5	525	400		
	3	2.913	3.702	14	175	CF		
	4	3.937	5.000	16	150	CF		
CBF	1/2	0.470	0.748	2	500	350	Full	Full
	3/4	0.720	1.048	2.75	500	350	Full	19
	1	0.970	1.354	4	500	350	Full	14
	1 1/2	1.540	2.034	6	350	245	Full	11
	2	1.970	2.464	7.5	250	175	22	8
	3	2.913	3.702	14	175	CF	20	5
	4	3.937	5.000	16	150	CF	15	2
CPB	1/2	0.470	0.855	2	300	CF	Full to 250 F	
	3/4	0.720	1.160	2.75	250	CF	Full to 250 F	
	1	0.970	1.440	4	250	CF	Full to 250 F	
	1 1/2	1.540	2.155	6	200	CF	Full to 230 F	
	2	1.970	2.560	7.5	200	CF	Full	15
	3	2.913	3.922	14	125	CF	CF	CF
	4	3.937	5.221	16	100	CF	CF	CF
CPBF	1/2	0.470	0.855	2	250	CF	Full to 250 F	
	3/4	0.720	1.160	2.75	250	CF	Full to 250 F	
	1	0.970	1.440	4	250	CF	Full to 250 F	
	1 1/2	1.540	2.155	6	200	CF	Ful	13 at 250 F
	2	1.970	2.560	7.5	200	CF	Full	11 at 250 F
	3	2.913	3.922	14	125	CF	20	9 at 250 F
	4	3.937	5.221	16	100	CF	16	5 at 250 F

(CF = Consult Factory)

Sanitary Tri-Clamp® and Mini Sanitary

Tri-Clamp®

Surface finishes meet or exceed FDA, USDA, and 3A standards. 25 Ra to custom electropolishing available

Standard Step Size Fittings

		Connection Tube Diameter				
		1/2"	3/4"	1**	1 1/2"	2"
Hose Tube Diameter	1/2"		X	X	X	
	3/4"			X	X	
	1**				X	X
	1 1/2"					X

* ASME BPE Type B, for Type A Consult Factory
Consult factory for step sizes and other size clamp fittings not shown herein.

Commonly Selected Material

316 Stainless Steel
Teflon® PFA Encapsulated
Kynar®



TRI-CLAMP® AND MINI SANITARY FITTING PRESSURE RATINGS

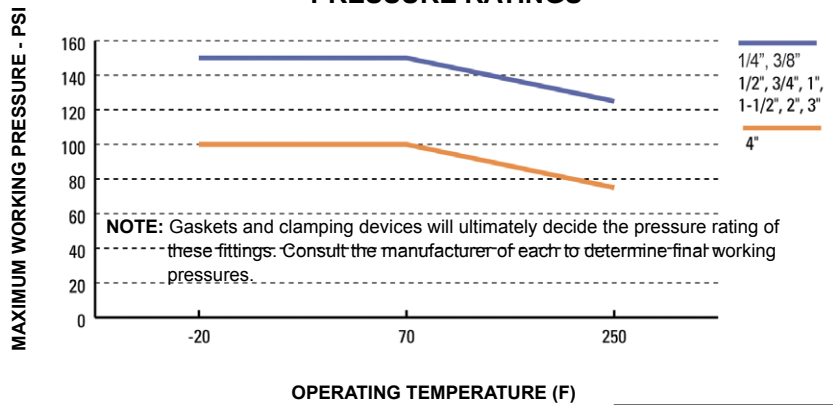

Resistoflex hygienic clamp fittings are per ASME BPE Standard.

The Bioprocessing Equipment (BPE) 2005 edition created an industry standard for clamp dimensions and tolerances, defining two types of fittings, Type A and Type B. Type A is designated for all controlled-compression type fittings; Type B is for all free-compression fittings. The 2009 edition recognizes both Types A & B in the 1" Nominal Size Clamp Ferrule, creating a situation where both would be acceptable to meet the current standard. We offer the following diagrams to help minimize confusion when selecting these fitting styles.

Sanitary Tri-Clamp®		
Size	A	B
1"	2.694	1.718
1-1/2"	3.041	1.967
2"	3.328	2.250
3"	5.094	3.400
4"	4.625	3.625

Mini Sanitary		
Size	A	B
1/2"	2.500	1.618
3/4"	2.500	1.618

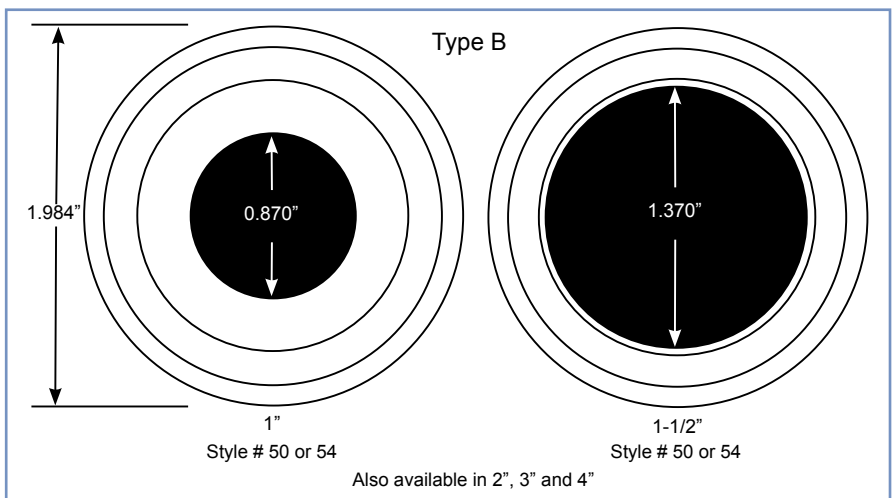
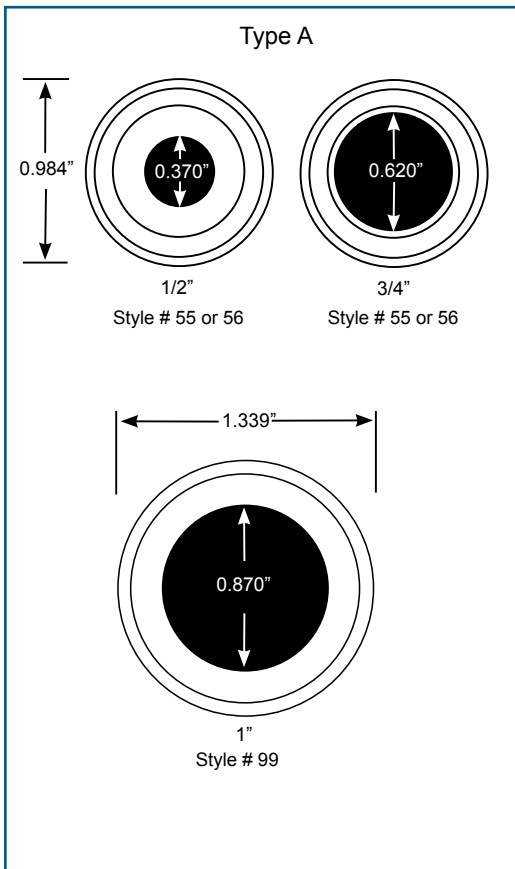

Sanitary I-Line® and Bevel Seat



Female I-Line®
Style # 61 or 63



Male I-Line®
Style # 60 or 59

I-LINE AND BEVEL SEAT FITTING PRESSURE RATINGS

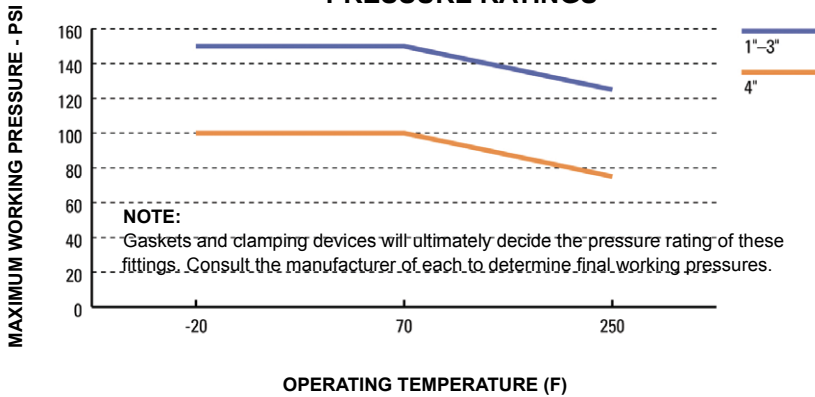

Female Bevel Seat		
Size	A	B
1"	2.656	1.718
1-1/2"	4.000	1.967
2"	4.625	2.250
3"	4.875	3.400

Male Bevel Seat		
Size	A	B
1"	3.218	1.718
1-1/2"	3.569	1.967
2"	3.844	2.250
3"	5.719	3.400

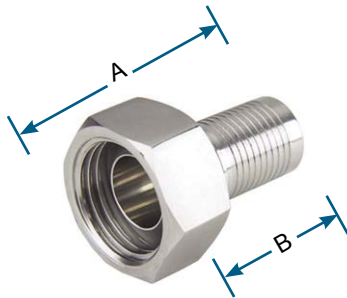

Female Bevel Seat
Style # 66

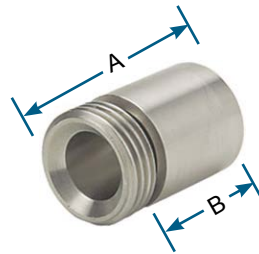

Male Bevel Seat
Style # 65



90° Elbow
Style # 5L



45° Elbow
Style # 5K

I-Line®

■ **Standard Material**

316 Stainless Steel

■ **Custom Material**

Monel®

Hastelloy®

■ **Standard Material**

316 Stainless Steel

■ **Custom Material**

Monel®

Hastelloy®

Cam & Groove

Cam & Groove

Female/Male Cam Insert

Standard insert: Solid metal or plastic
Teflon® PFA encapsulated: Injection molded high purity PFA Teflon® over entire hose shank and throughout wetted areas of fitting

Teflon® PTFE Flared Thru: Hose liner extends throughout the insert and is flared over the face under the cam gasket on the female cam only

Commonly Selected Insert Material

316 Stainless Steel
 Teflon® PFA Encapsulated

Rotating Female Cam Body

316 SS is standard. Custom materials are available. Female cams are available with standard or locking handle systems.

Female Cam Body Options

316 Stainless Steel

Stainless Steel Cam & Groove (Locking Handles Standard)

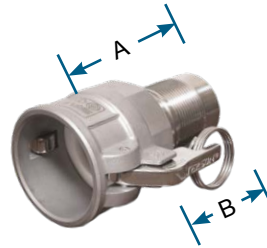

Female Cam & Groove Style # 78

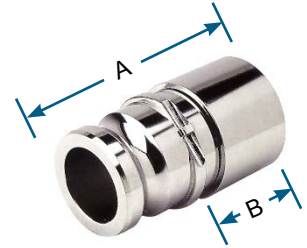

Male Cam & Groove Style # 70

Female Cam & Groove		
Size	A	B
1/2"	2.906	1.618
3/4"	2.906	1.618
1"	3.008	1.718
1-1/2"	3.225	1.967
2"	3.538	2.250
3"	5.300	3.100
4"	6.810	3.630

Male Cam & Groove		
Size	A	B
1/2"	3.306	1.618
3/4"	3.306	1.618
1"	3.518	1.718
1-1/2"	4.217	1.967
2"	4.950	2.250
3"	5.775	3.400
4"	7.000	3.625

Teflon® PFA Encapsulated Cam & Groove (Conductive liner available)



Female Encapsulated Style # 78 E or 78 A



Male Encapsulated Style # 70 E or 70 A

Size	C-ID
3/4"	.485
1"	.550
1-1/2"	.935
2"	1.44



Flange X Cam Adapter PFA Encapsulated

Sizes available: 3/4" through 3", rotating flanges all materials (see page 38).

Available Flange X Male Cam and Flange X Female Cam.

Consult factory for information.

Flanged (Rotating)

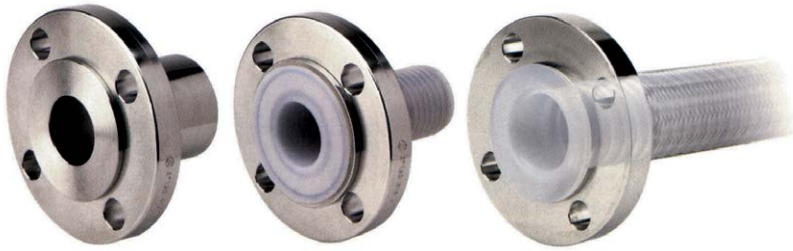

Standard Retainer
Style # 30

Teflon® PFA Encapsulated:
Style # 30 E or 30 A
Injection molded Teflon® PFA over entire hose shank and throughout wetted areas of fitting

Teflon® PTFE Flared Thru:
Style # 35
Hose liner extends through the retainer and is flared over the face

Rotating Flanges

150# and 300#

Commonly Selected Retainer Choices

- 316 Stainless Steel
- Teflon® Encapsulated
- Flared Thru
- Monel®
- Hastelloy®
- and more

Flange Option: 150# and 300#

See page 38



Ductile Iron

Stainless

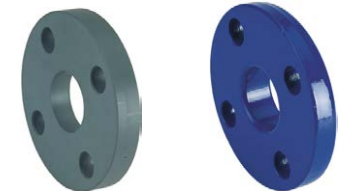

Plastic

Epoxy Coated Carbon Steel

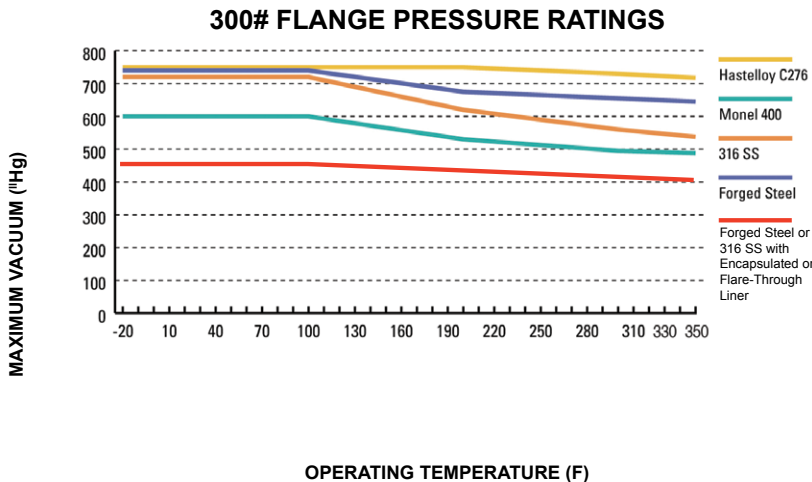
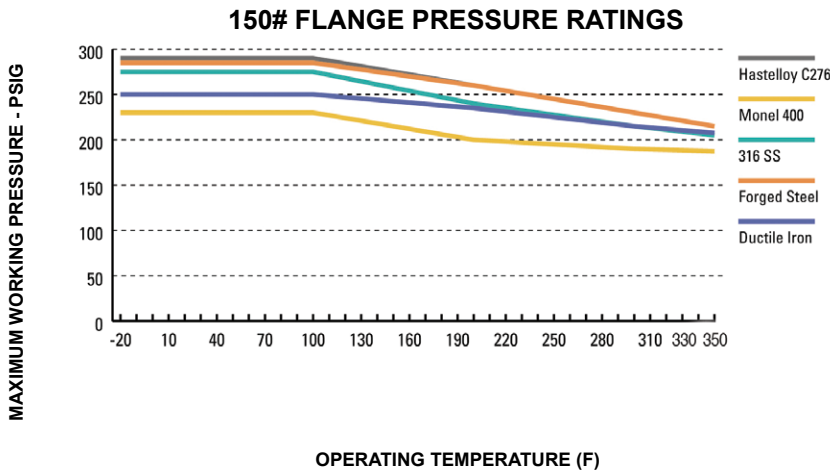
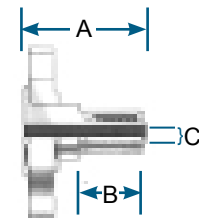

Flange & Retainer				
Size	A	B	C	C Encapsulated Retainer
1/2"	3.066	1.618	.38	N/A
3/4"	3.186	1.618	.42	.485
1"	3.346	1.718	.99	.550
1-1/2"	3.725	1.967	1.28	.435
2"	4.128	2.250	1.75	1.44
3"	5.618	3.400	3.07	N/A
4"	6.218	3.625	4.03	

Female JIC & Male/Female NPT

Female JIC

- Joint Industrial Conference SAEEJ514 specifications
- 37 (degree symbol) JIC metal-to-metal sealing
- Available on 1/4" through 2" hose assemblies
- Wide range of adaptors available

Male & Female NPT

- NPT – American National Standard
- Also available with British Standard Pipe Taper (BSPT), Japanese Industrial Standard (JIS) and metric threads

Female JIC		
Size	A	B
1/2"	2.162	1.618
3/4"	2.197	1.618
1"	2.353	1.718
1-1/2"	2.774	1.967
2"	3.403	2.250

Female NPT		
Size	A	B
1/2"	2.868	1.618
3/4"	2.868	1.618
1"	3.075	1.718
1-1/2"	3.440	1.967
2"	4.083	2.250
3"	7.199	3.400
4"	7.700	3.625

Male NPT		
Size	A	B
1/2"	2.921	1.618
3/4"	3.000	1.618
1"	3.270	1.718
1-1/2"	3.582	1.967
2"	3.937	2.250
3"	5.861	3.400
4"	7.000	3.625

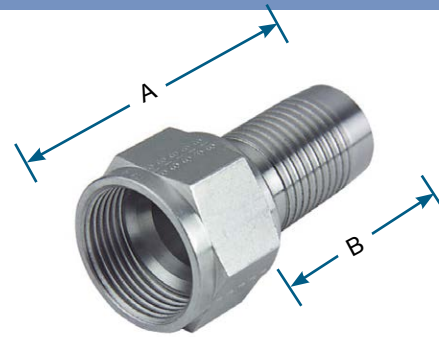

Female JIC
Style # 15

FEMALE JIC STAINLESS FITTINGS PRESSURE RATINGS

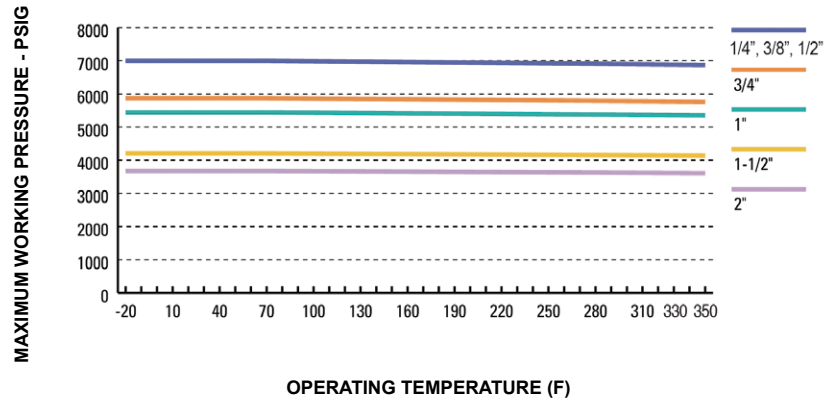

Female NPT
Style # 11



Male NPT
Style # 10

316 SS MALE AND FEMALE NPT FITTINGS PRESSURE RATINGS

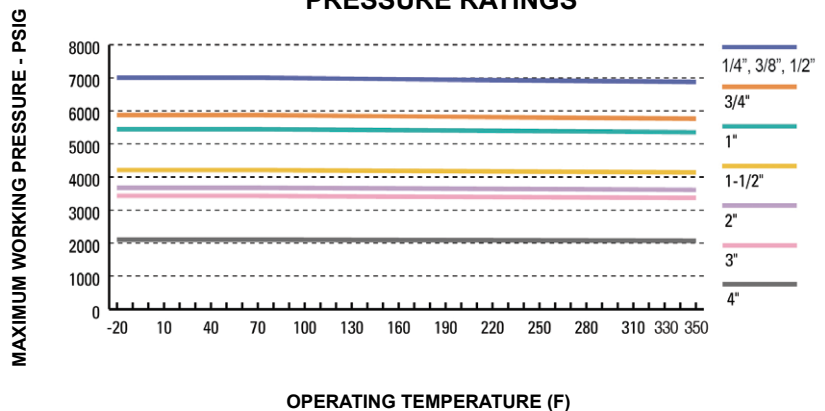

Compression Tube

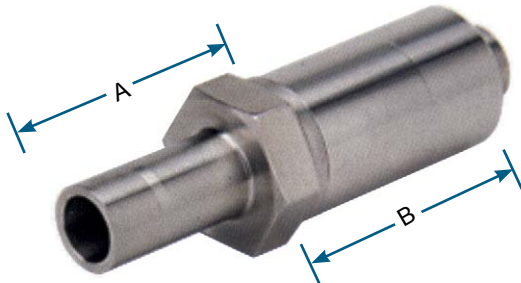

Tube Adapter
Style # 25

Tube Adapter		
Size	A	B
1/2"	3.000	1.618
3/4"	3.055	1.618
1"	3.610	1.718

316 SS COMPRESSION FITTINGS PRESSURE RATINGS

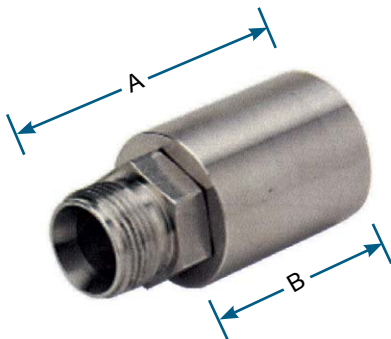
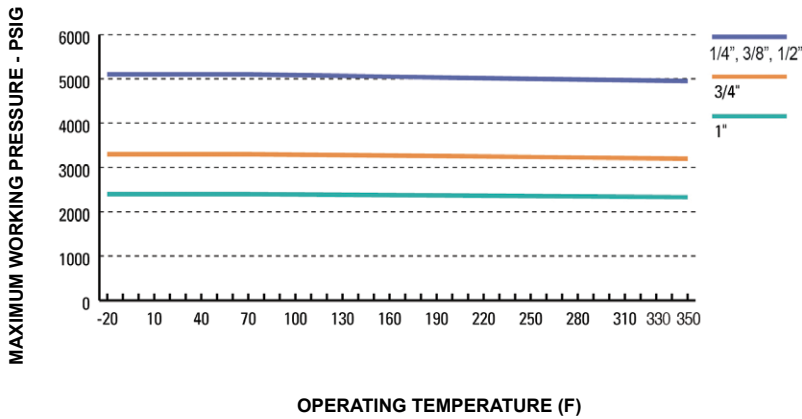

Tube Connector
Style # 20



Tube Connector with Nut and Ferrule
Style # 21

Tube Connector Male		
Size	A	B
1/2"	2.500	1.618
3/4"	2.500	1.618
1"	2.875	1.718

Compression Tube

■ Compression Tube Adapter/Connector

- Tube adapter plain or with nut and ferrule
- Tube connector plain or with nut and ferrule

■ Commonly Selected Material

316 Stainless Steel

Adaptors and Accessories

Sanitary Adapters

■ PTFE and PFA-Lined

- Straight or reducing
- Tri-Clamp, I-Line, Bevel Seat x Flange, Cam-Lock and other connections



PTFE-Lined Female I-Line x Male I-Line Reducer

Flange Adapters

■ PTFE and PFA-Lined

- Available in stainless steel and other alloys
- ANSI, DIN, JIS, and other drillings x sanitary, camlock and other connections.

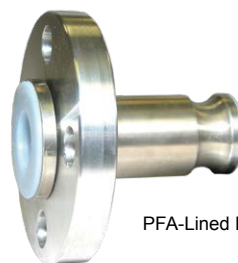

PFA-Lined Flange x Male Cam Lock



PTFE-Lined Flange x Tri-Clamp

Tagging/Marking Options

- Paper tag
- SS tag wired on hose
- Encapsulated label for silicone hoses (pictured)
- Pin stamp on collar



Features Comparison

Hose	Description	Features							
		Clean Packaging of Assemblies	Fitting Lot Traceability (Contact Surface)	Hose Liner Lot Traceability	USP Class VI Certification	Meets or Exceeds FDA CFR:	USDA and 3A Accepted	Meets or Exceeds ISO 10993	Meets or Exceeds European Pharmacopoeia 3.1.9
STRATUS™									
	Smooth Teflon® PTFE-Lined Silicone Hose	Max. 24 Ft.	✓	✓	✓	177.1550 177.2600	✓	CF	CF
Cirrus	Smooth Teflon® PTFE-Lined, Cleanable EPDM Rubber Cover	Max. 75 Ft.	✓	✓	✓	177.1550	✓	CF	CF
TRC FLARED THRU	Smooth Teflon® PTFE-Lined EPDM Rubber Covered Hose	Max. 20 Ft.	Consult Factory	✓	✓	177.1550	✓	CF	CF
Si-B	Braid Reinforced Silicone Hose	Max. 100 Ft.	✓	✓	✓	177.2600	✓	✓	✓
Si-B HD	Braid Reinforced Silicone Hose	Max. 100 Ft.	✓	✓	✓	177.2600	✓	✓	✓
Si-W	High Pressure Silicone Hose	Max. 24 Ft.	✓	✓	✓	177.2600	✓	✓	✓
Si-V	Silicone Suction Hose	Max. 24 Ft.	✓	✓	✓	177.2600	✓	✓	✓

Quality Assurance

CRANE ChemPharma, ResistoPure hoses are qualified to an extremely rigorous quality assurance program. The following tests are performed on 100% of our hose designs, ensuring that every unit meets performance specifications.

ResistoPure Qualification Testing

1.0 Test Method

1.1 *Qualification Tests:* Hose designs shall pass qualification tests designed to demonstrate the hose's ability to withstand severe operating conditions. Once a hose design has passed qualification testing, re-testing is not required. If the manufacturer changes the hose design, however, the new design must be re-tested. The hose manufacturer shall make hose qualification test reports available upon request. Qualification testing is as follows:

1.1.1 *Burst Testing:* Subject hose to destructive burst test to determine allowable operating pressure and proof test pressure.

- 1.) Install hose on test stand, introduce hydraulic fluid into hose, purge all air.
- 2.) Pressurize at an approximate rate of 100 psi/sec. until hose fails.
- 3.) Record burst pressure.
- 4.) Allowable operating pressure is defined as 25% of burst pressure for a 4:1 safety factor.

Note: Allowable operating pressure is also known as "rated working pressure" and "working pressure."

1.1.2 *Steam-Cold Water Cycling:* Subject representative Teflon®-lined hose samples to steam-cold water cycling to determine the ability of the lined hoses to withstand rapid temperature changes. Procedure is as follows:

- 1.) Install hose on closed-loop test stand and circulate saturated steam at 125±5 psig (50 psig for TRC hose) until the skin temperature varies no more than ±2.5°F for 10 minutes. Temperature shall be measured by a thermocouple attached to the crimp collar.
- 2.) Close off the steam and immediately circulate water at a maximum temperature of 77°F until the skin temperature reaches 122°F.

- 3.) Vent and introduce air to purge the test hose for a minimum of one minute to completely drain hose of water.
- 4.) Repeat steps 1-3 for a total of 100 cycles.
- 5.) During testing, leakage is cause for rejection.

1.1.4 *Vacuum Testing:* Subject representative hose assemblies to vacuum conditions to determine rated vacuum for hose at a given temperature.

- 1.) Reach the desired vacuum/temperature level and hold for 48 hrs.
- 2.) Turn off the oven and allow the hose to cool to ambient temperature while still under the same vacuum level.
- 3.) Remove the hose and inspect for buckling or collapse of the liner. Any buckling or collapse of the liner shall be cause for rejection.
- 4.) If no collapse or buckling has occurred, the vacuum and temperature shall be considered acceptable.

1.2 *Proof Testing for Customer Orders:* 100% of finished hose assemblies shall be proof tested.

- 1.2.1 Factory-made assemblies shall be proof-tested hydrostatically at 1.5 times rated working pressure with high-purity deionized water
- 1.2.2 Hose assemblies made at an Authorized Fabricating Distributor location shall be hydrostatically proof-tested.

Teflon® Provides Unsurpassed Purity

Teflon® in High Purity Applications

Only Teflon® PTFE used in CRANE ChemPharma, ResistoPure hoses offers true protection against all sources of contamination. We've been making our PTFE hose liner for more than 50 years!

CRANE ChemPharma, ResistoPure PTFE liners contain no plasticizers, fillers, or antioxidants that leach out and react with process fluids.

Properly designed sanitary fittings are a given. However, the surface area exposure of fittings is minimal compared to the hose liner.

CRANE chemPharma, ResistoPure hoses feature DuPont Teflon® PTFE resin which meets every major high-purity classification:

- Meets 3A Sanitary Standards
- Meets FDA 21 CFR 177.1550
- USDA Accepted

The following results illustrate CRANE ChemPharma, ResistoPure's products of unequaled purity.

In the effort to produce water of the highest purity for the semiconductor, pharmaceutical, and biotech industries, engineers are designing fluid handling systems that do more than just last for a short period of time. These fluid handling systems must be designed to prove that they contribute less than parts per billion of extractables to the process water.

Particulate, ionic, organic, or microbial contaminants in process fluids reduce product yields dramatically, requiring purity levels which are orders of magnitude greater than the past. One of the harshest and most widely publicized agents used for wet processing is deionized 18 megohm-cm water. To determine the effect 18 megohm-cm water has on CRANE ChemPharma, Resistoflex PTFE-lined hoses, an extractable analysis was conducted by AT&T Analytical Services. AT&T's analysis consisted of "dynamic rinsing" of CRANE ChemPharma, ResistoPure PTFE-lined hose samples and subsequent ionic characterization.

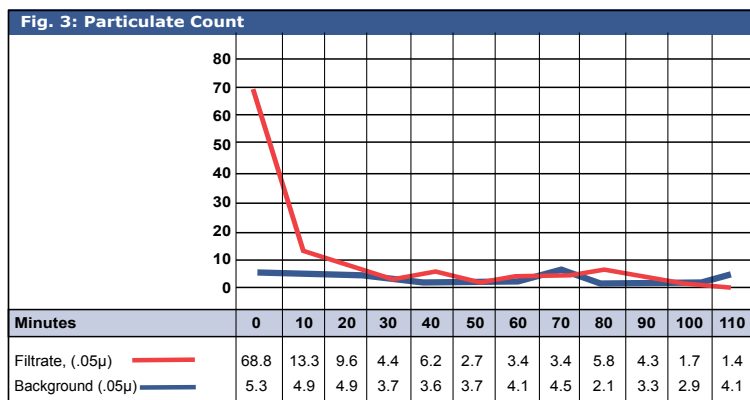

of ultrapure water is considered a "clean" process and does not produce any undesirable chemical byproducts. Unlike traditional chemical disinfectants, ozone dissipates from the treated water due to its own natural decay properties. Because of this, ozone is gaining increasing popularity in electronics, pharmaceuticals, and other ultrapure water-dependent industries. However, the same aggressive nature that gives ozone the ability to attack and kill microorganisms also makes it especially tough on the materials with which it comes in contact. As opposed to silicone hoses, CRANE ChemPharma, ResistoPure PTFE hoses are chemically inert and non-reactive with ozone.

Please contact CRANE ChemPharma, ResistoPure for a copy of AT&T's detailed report.

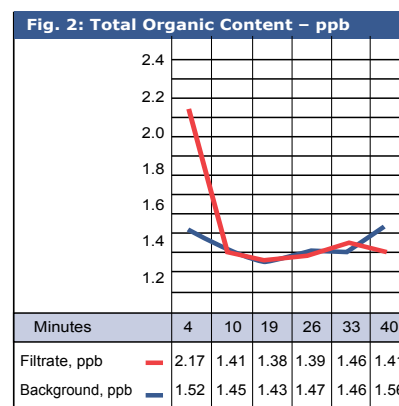
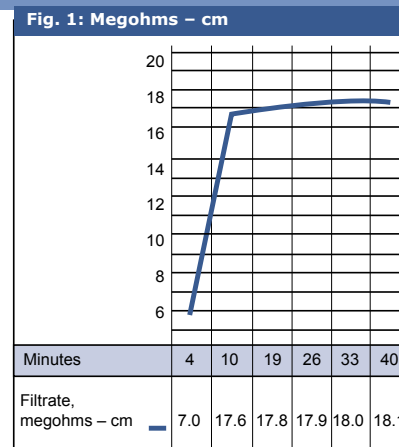

As seen in Fig. 1, rinse to background occurred within 5 minutes. Organics were determined by total organic carbon (TOC) analysis, which also can be seen in Fig. 2. TOCs were below background levels within 10 minutes.

Particulate dynamic rinse data is shown in Fig. 3. Particle count rinsed to background levels within 50 minutes, proving that the CRANE ChemPharma, ResistoPure PTFE liner has a very smooth, contamination-free surface that will not support microbe growth.

Finally, Inductively Coupled Plasma-Mass Spectroscopy (ICP-MS) data for 68 metals and anion analysis samples were taken at 24 hours of dynamic rinse exposure with 18 megohm water. In all cases, extractables were below detectable limits for CRANE ChemPharma, ResistoPure PTFE hoses.

The use of ozone in ultrapure water processing has proven to be a quick and reliable method of microbial control. Ozonization

Technical Information

► Related Definitions

Rated Working Pressure: Maximum operating pressure at which the hose may operate through the stated bending range.

Proof Test Pressure: Not to exceed 1-1/2 times rated working pressure.

Burst Pressure: The average pressure at which the hose can be expected to fail at 70°F.

Minimum Bend Radius: The bend radius to which a hose may be bent when no further motion is to be imposed.

Dynamic Bend Radius: The bend radius used in calculations involving applications where the hose is moving. This bend radius has a direct relation to cycle life. Bending the hose in a smaller radius than rated will adversely affect the life of the hose.

Live Length: The length of hose that will bend, or the length of hose between the braid collars (LL).

Overall Length: The total face-to-face length of a straight hose (OAL).

Length Tolerances*:	Min.-18" assemblies	+/- .250"
	19"-36" assemblies	+/- .500"
	37"-50" assemblies	+/- .750"
	51"-Max. assemblies	+/- 1.5%

* Standard tolerances. Consult factory if tighter tolerances are required.

► Installation and Motion Considerations

Axial Motion: Motion that occurs when a hose is compressed along its longitudinal axis. Axial motion is only applicable in very short lengths of annular hose only. Hoses should not be subjected to axial motion.

Lateral Offset Motion: (Fig. 1) Motion that occurs when one end of the hose is deflected in a plane perpendicular to its longitudinal axis with the ends remaining parallel. In offset applications where motion is repeated, the offset should never exceed 25% of the minimum bend radius.

$$OAL = LL + \text{Fitting Length A} + \text{Fitting Length B}$$

Note: Where offset motion "Y" occurs on both sides of hose centerline, the hose live length should be based on total travel or 2Y.

Angular Offset Motion: Angular movement is defined as the bending of the hose so that the ends are no longer parallel. Amount of movement is measured in degrees from centerline of the hose.

Radial Motion: This type of movement occurs when the hoses are bent in a 180 degree arc such as in vertical or horizontal loops. In this configuration, two types of movement are possible. One is where the bend radius remains constant and one end of the hose moves parallel to the other end. The other is where the ends move perpendicular to each other so as to enlarge or decrease the width of the loop.

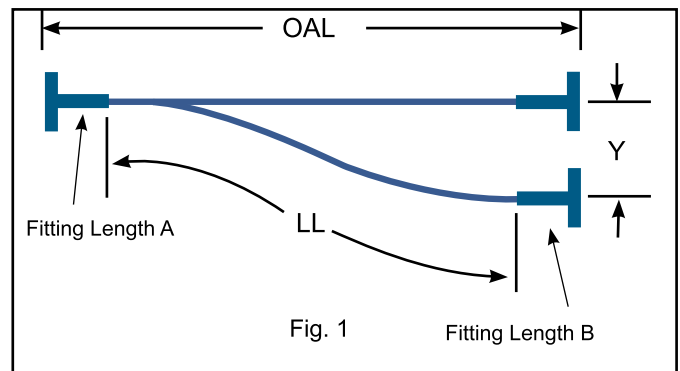

For more consideration on best practices for hose installation and determining the proper length of a hose assembly, please refer to the NAHAD website at www.nahad.org.

Steam & Temperature Conversion

Steam Table			
Temp (°F)	Pressure (psig)	Temp (°F)	Pressure (psig)
212	0.000	274	29.982
213	0.294	276	31.451
214	0.593	278	32.957
215	0.896	280	34.504
216	1.205	282	36.090
217	1.518	284	37.718
218	1.837	286	39.387
219	2.161	288	41.099
220	2.490	290	42.854
221	2.825	292	44.654
222	3.164	294	46.498
223	3.510	296	48.388
224	3.860	298	50.325
225	4.216	300	52.309
226	4.578	302	54.342
227	4.946	304	56.423
228	5.319	306	58.555
229	5.698	308	60.737
230	6.083	310	62.971
232	6.871	312	65.257
234	8.683	314	67.597
236	8.520	316	69.992
238	9.383	318	72.441
240	10.272	320	74.947
242	11.187	322	77.509
244	12.130	324	80.130
246	13.101	326	82.810
248	14.100	328	85.549
250	15.129	330	88.349
252	16.187	332	91.211
254	17.276	334	94.136
256	18.395	336	97.124
258	19.547	338	100.177
260	20.731	340	103.296
262	21.948	342	106.481
264	23.198	344	109.734
266	24.483	346	113.055
268	25.804	348	116.446
270	27.160	350	119.908
272	28.553		

Temperature Conversion					
°C	Given Temp °C or °F	°F	°C	Given Temp °C or °F	°F
-34	-30	-22	+63	+145	+293
-32	-25	-13	+66	+150	+302
-29	-20	-4	+68	+155	+311
-25	-15	+5	+71	+160	+320
-23	-10	+14	+74	+165	+329
-21	-6	+23	+77	+170	+338
-18	0	+32	+79	+175	+347
-15	+5	+41	+82	+180	+356
-12	+10	+50	+85	+185	+365
-9	+15	+59	+88	+190	+374
-7	+20	+66	+90	+195	+383
-4	+25	+77	+93	+200	+392
-1	+30	+86	+96	+205	+401
+2	+35	+95	+99	+210	+410
+4	+40	+104	+102	+215	+419
+7	+45	+113	+104	+220	+428
+10	+50	+122	+107	+225	+437
+13	+55	+131	+110	+230	+446
+16	+60	+140	+113	+235	+455
+18	+65	+149	+116	+240	+464
+21	+70	+158	+118	+245	+473
+24	+75	+167	+121	+250	+482
+27	+80	+178	+124	+255	+491
+29	+85	+185	+127	+260	+500
+32	+90	+194	+129	+265	+509
+35	+95	+203	+132	+270	+518
+38	+100	+212	+135	+275	+527
+41	+105	+221	+138	+280	+536
+43	+110	+230	+141	+285	+545
+46	+115	+239	+143	+290	+554
+49	+120	+248	+146	+295	+563
+52	+125	+257	+149	+300	+572
+54	+130	+266	+152	+305	+581
+57	+135	+275	+154	+310	+590
+60	+140	+284	+157	+315	+599

If the given temperature (in the shaded column) is Celsius, read Fahrenheit in the column to the right. If the given temperature (in the shaded column) is Fahrenheit, read Celsius in the column to the left.

Assembly Part Numbers

STRATUS
Order Section

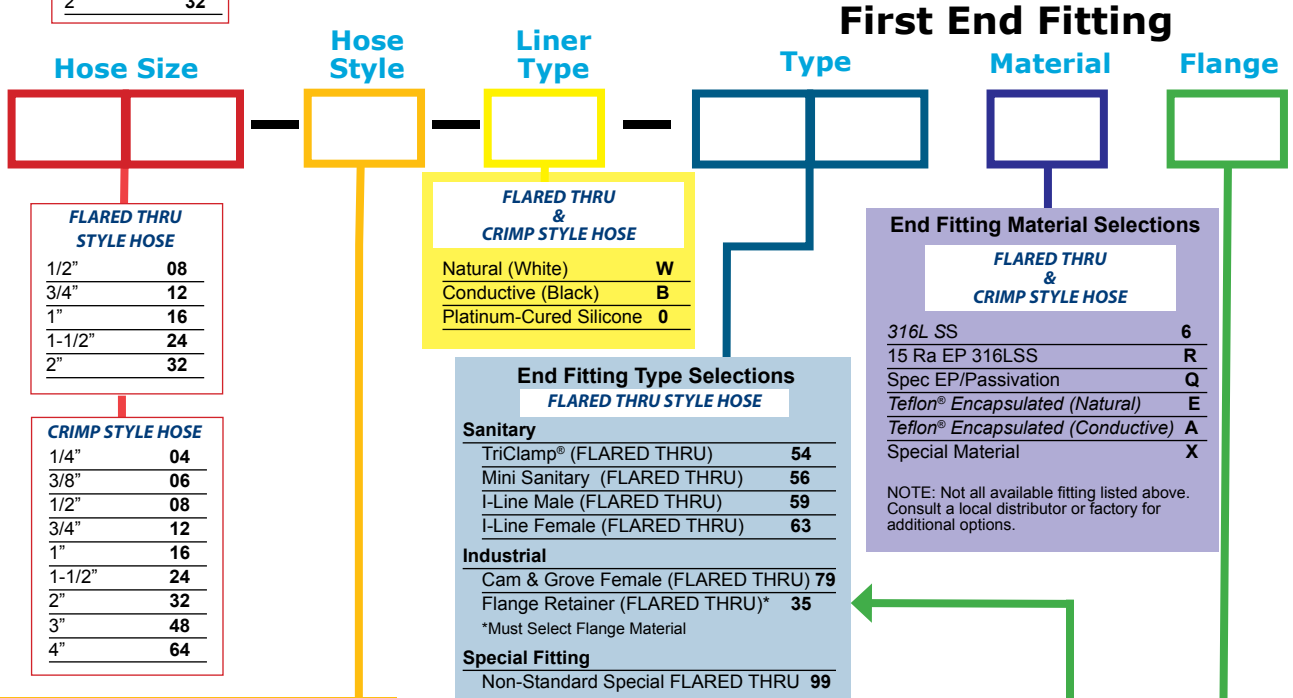
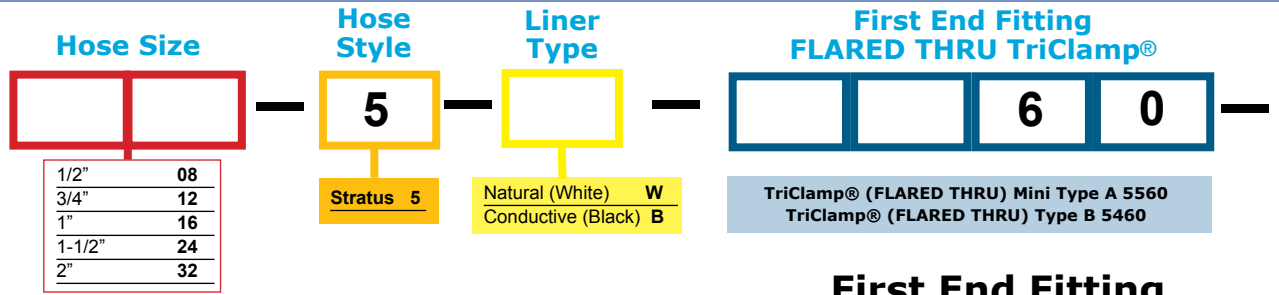

FLARED THRU STYLE HOSE		
Rubber Covered Smooth-Bore PTFE Teflon®		
TRC Blue EPDM w/PTFE Tube		B
Braided Smooth-Bore PTFE Teflon®		
SBT Stainless Braid		F
Braided Convoluted-Bore PTFE Teflon®		
CB Stainless Braid		S
CPB Polypropylene Braid		P

CRIMP STYLE HOSE		
Rubber Covered Smooth-Bore PTFE Teflon®		
Cirrus™ PTFE Gray EPDM w/PTFE Teflon®		C
TRC Teflon® Blue EPDM w/PTFE Teflon®		B
TRC Teflon® Green EPDM w/PTFE Teflon®		G
Braided Smooth-Bore PTFE Teflon®		
SBT Stainless Braid		F
Braided Convoluted-Bore PTFE Teflon®		
CB Stainless Braid		S
CPB Polypropylene Braid		P
Platinum Cured Silicone		
Si-B Polyester Braided		1
Si-B HD Polyester Braided		4
Si-W 4-Ply, Polyester Wrapped		2
Si-V 4-Ply, Wire Reinforced		3

CRIMP STYLE HOSE	
Sanitary	
TriClamp®	50
TriClamp® (One Step Up)	51
TriClamp® (Two Steps Up)	52
TriClamp® 45° Elbow	57
TriClamp® 90° Elbow	53
Mini-Sanitary	55
Mini-Sanitary 45° Elbow	5K
Mini-Sanitary 90° Elbow	5L
Mini-Sanitary Step-Up	58
I-Line Male	60
I-Line Female	61
I-Line Female (One Step Up)	62
Bevel Seat Male	65
Bevel Seat Female	66
Female SMS Swivel	68
Female DIN Swivel	69
Industrial	
Male Pipe (NPT)	10
Female Pipe (NPT)	11
Tube Connector (Plain)	20
Tube Connector (w/Nut & Ferrule)	21
Tube Adapter (Plain)	25
Tube Adapter (w/Nut & Ferrule)	26
Male Cam	70
Female Cam w/Locking Handle	78
Flange Retainer*	30
*Must Select Flange Material	
Special Fitting	
Non-Standard Special	99

NOTE: Not all available fitting listed above. Consult a local distributor or factory for additional options.

Flange Material Selections	
FLARED THRU STYLE HOSE & CRIMP STYLE HOSE	
No Flange	0
316L Stainless 150#	6
316L Stainless 150# (Domestic)	7
316L Stainless 300#	G
316L Stainless DIN PN10	N
Carbon Steel (Epoxy Coated) 150#	0

NOTE: Not all available flanges listed above. Consult a local distributor or factory for additional options.

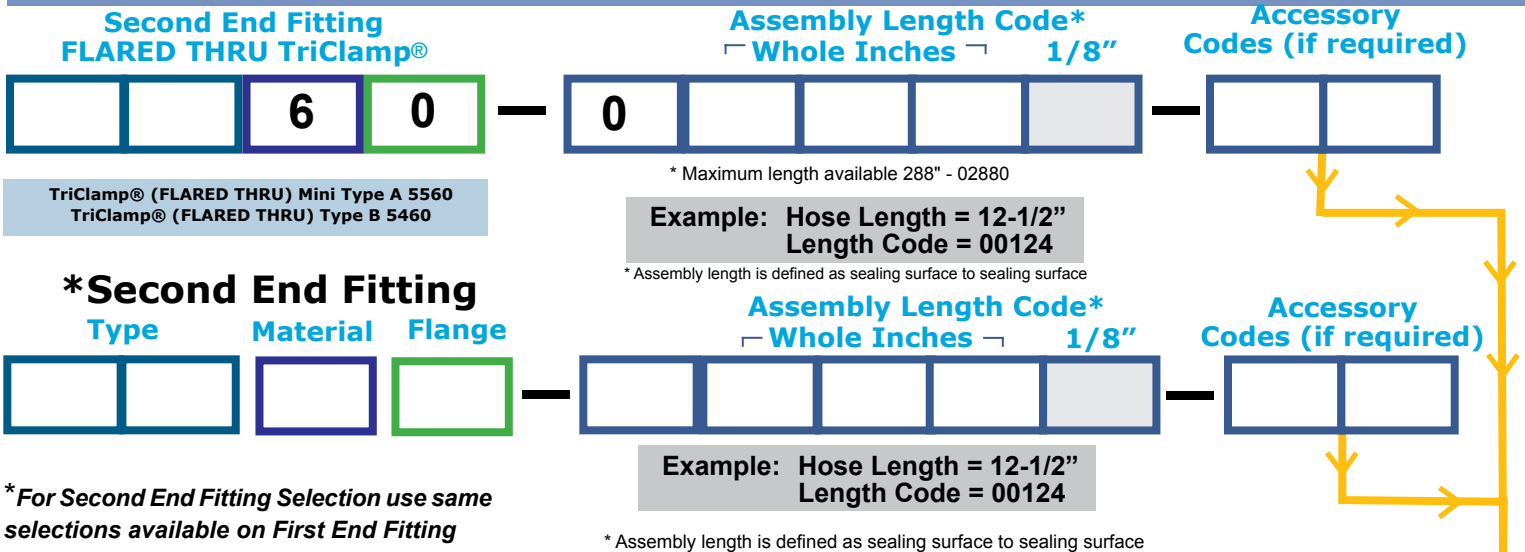

EXAMPLES:

1.5" Diameter Smooth-Bore Teflon® PTFE Natural tube with stainless steel braid reinforcement, TriClamp® fittings with 15Ra electropolished fittings on each end, 36" overall length.

24 F W 5 0 R 0 5 0 R 0 – 00360

1" Diameter EPDM Reinforced Teflon® PTFE lined hose, conductive PTFE tube with I-Line Male FLARED THRU on one end, TriClamp® FLARED THRU on one end. Overall Length 6'. Metal Tag "CIP"

16 B B 5 9 6 0 5 4 6 0 – 00720 - T

2" Diameter Smooth-Bore PTFE natural tube with a smooth EPDM cover, grey in color. Encapsulated TriClamp® on one end, encapsulated flange retainer with 316 SS 150# Flange on the other end. Overall length 88 feet.

32 C W 5 0 E 0 3 0 E 6 - 10560

STRATUS, FLARED THRU & CRIMP STYLE HOSE

Accessories	
Metal Tag Attached (see note)	T
Paper Tag	TP
Pin Stamp on Collar	TC
Encapsulated Silicone Label	L
Clear Silicone Cover	D
Polyolefin Heat Shrink:	
Clear	PC
Red	PR
Black	PB
White	PW
* Other Colors available, consult factory	
* Other accessories available, consult factory	
Note: Content for tags to be specified in the description	
Special Accessory	X

NOTE: Not all available Accessories listed above. Consult a local distributor or factory for additional options.

Hastelloy® is the registered trademark name of Haynes International, Inc.
Monel® is a trademark for Special Metals Corporation.

Don't See Something You Need?
Call 828-724-4000
Ask for Hose Customer Service

ResistoPure™

Crane ChemPharma & Energy
One Quality Way,
Marion, North Carolina 28752
Phone: (828) 724-4000
Fax: (828) 724-2368
www.cranecpe.com

CRANE

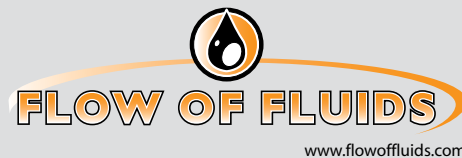

brands you trust.



COMPAC-NOZ

CRANE

DEPA

ELRO **DUO-CHEK**



KROMBACH
ARMATUREN

NOZ-CHEK



RESISTOFLEX



Saunders
the science inside

STOCKHAM



UNI-CHEK

w.ta.

XOMOX

Crane Co., and its subsidiaries cannot accept responsibility for possible errors in catalogues, brochures, other printed materials, and website information. Crane Co. reserves the right to alter its products without notice, including products already on order provided that such alteration can be made without changes being necessary in specifications already agreed. All trademarks in this material are property of the Crane Co. or its subsidiaries. The Crane and Crane brands logotype, in alphabetical order, (ALOYCO®, CENTER LINE®, COMPAC-NOZ®, CRANE®, DEPA®, DUO-CHEK®, ELRO®, FLOWSEAL®, JENKINS®, KROMBACH®, NOZ-CHEK®, PACIFIC VALVES®, RESISTOFLEX®, REVO®, SAUNDERS®, STOCKHAM®, TRIANGLE®, UNI-CHEK®, WTA®, and XOMOX®) are registered trademarks of Crane Co. All rights reserved.