



# INSTALLATION, OPERATION AND MAINTENANCE MANUAL

## **CRANE® FK-TrieX™ Full Port Triple Offset Isolation Valves For Severe Service**

**CRANE**

**v in** [www.cranecpe.com](http://www.cranecpe.com)

# Installation, Operation & Maintenance

## 1. Introduction

This manual is to support the user with installation, operation and maintenance of full port Triple Offset Valves, of the Crane FK-TrieX series

### ⚠ ATTENTION

**If instructions and warning notes in this manual are not adhered to, serious danger can arise and warranty of the manufacturer could become void.**

## 2. Intended Use

Crane FK-TrieX valves are exclusively designed to, (1) shut off or open pipe sections, (2) shutoff or open flow between flanges after installation in a pipe system, and (3) shut off flow within permissible pressure and temperature limits after the actuator has been connected to the system control. This is to take place after installation in a pipe system

- Between flanges in accordance with ASME 16.5 and 16.47 with raised face. These have to be mechanically processed parallel and level and which have to be flush.
- Media with maximum operating pressure PS, which is indicated for the maximum permissible temperature TS on the name plate of the valve

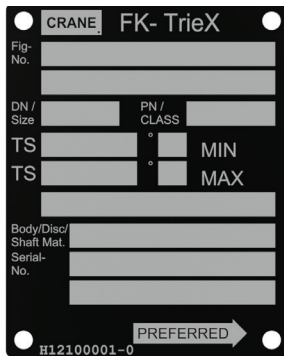

CRANE®FK-TrieX name plate without CE marking

- With permissible values of operating temperature/ Pressure
- With manual actuation or after connection of the actuator or gear to the system control.
- Shut off or open flow, when installed in a pipeline system (between flanges) of media in allowable pressure and temperature limits of pipeline sections, by routing or directing the flow

Any other use of the FK-TrieX valve is considered unintended.

## 3. Safety Notes

### 3.1 General Safety Notes

Valves are subject to the same safety regulations as the piping system in which they are installed. This manual only provides such safety notes which are to be observed in addition to those standards.

### 3.2 Safety Notes For The Operator

- The valve is only used as intended, as it is described in section 2

### ⚠ ATTENTION

**No valve must be operated above the permissible pressure/ temperature range (=“rating”) of which is insufficient for the operating condition: this permissible range is described in section 2.**

**Application limits for pressure and temperature are marked on the valve. Non-compliance of this instruction involves risk to life and limb and may cause damage to the pipe system.**

**It has to be ensured that the selected materials of valve parts that are in contact with the flowing medium are suitable for the media. Manufacturer does not assume any liability for damage resulting from corrosion caused by aggressive media. Non-compliance of this instruction may involves risk to life and limb and may cause damage to the pipe system**

Dead-End-Service: Valves can be used for dead-end application in B and A flow direction only:

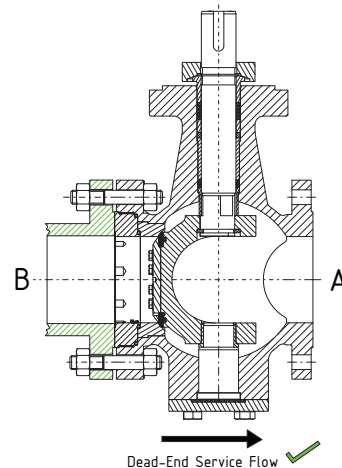

## Installation, Operation & Maintenance

- A manual gear which is subsequently mounted on the valve is adapted to the valve and correctly adjusted in both end positions of the valve – especially in the closing position.
- An actuating unit which is subsequently mounted on the valve is adapted to the valve and correctly adjusted in both end positions of the valve – especially in the closing position.
- The pipe system and the control system are professionally mounted. The wall thickness of the valve body is dimensioned so that in such professionally routed pipelines, an additional load  $F_z$  of the standard range ( $F_z = \pi/4 \times DN^2 \times PS$ ) is considered. With FK-TrieX valves, even higher values for  $F_z$  can be permitted, ( $PS =$  maximum permissible rated pressure at room temperature),
- The valve is professionally connected to these systems,
- In the pipe system, usual flow rates (e.g. 4 m/s for liquids) in continuous operation are not exceeded and abnormal operating conditions such as vibrations, water hammers, temperature shocks, cavitation, wet steam with a high water content and more than insignificant portions of solids in the medium – especially abrasive ones – are absent. If present, user has to consult with the manufacturer
- Valves which are operated at operating temperatures of  $>50^\circ\text{C}$  ( $122^\circ\text{F}$ ) or  $<-20^\circ\text{C}$  ( $-4^\circ\text{F}$ ) are protected against contact together with the pipe connections,
- The valve is only operated and maintained by personnel who are experts in pressurized pipelines.

### 3.3 Particular Dangers

#### ⚠ ATTENTION

**The valve shaft is sealed by a stuffing box. Before the nuts on the stuffing box gland are loosened or unscrewed, pressure in the pipeline has to be completely reduced so that no medium escapes from the stuffing box.**

**Before loosening the cover on the housing or before removing the valve from the pipeline, pressure in the pipeline has to be completely reduced so that the medium does not uncontrollably escape from the line.**

**For valves which are used as terminal valve: With normal operation, especially with gaseous, hot and/or hazardous media, a dummy flange or a sealing cover has to be mounted on the free connecting end or, only for short-term use, the valve has to be securely locked in "CLOSED" position.**

#### ⚠ ATTENTION

**If a valve as a has to be opened in a pressurized line as a terminal valve, this must be accomplished with utmost caution so that the squirting-out medium does not cause any damage. Take care when closing such a valve: danger of squashing!**

**If a valve has to be removed from a pipeline, medium may escape from the line or the valve. In the case of media which are harmful to health or hazardous, the pipeline has to be completely empty before the valve is removed.**

**Take care with residues which can continue to flow from dead spaces or which remain in the valve (under pressure)**

Valve needs to be pressure tested with flanges on both ends.

## 4. Transport and Storage

Valves have to be handled, transported and stored carefully:

- The valve is to be kept in its original packaging with the protection caps on the flange connections. Valves should be kept and transported (also to the installation site) on a pallet (or supported in a similar way).
- If the packaging does not feature any damage, valves should be unpacked just before their installation in the pipeline.
- In the case of storage prior to installation, the valve is to be stored in a closed room and to be protected against harmful influences like dirt or moisture.
- Especially the gear and the flange connection faces must not be damaged by mechanical or any other influences
- Valves are to be stored as delivered. The valve gear must not be operated.
- Especially the actuator and the flange connection faces must not be damaged by mechanical or any other influences.
- Valves are to be stored as delivered. The actuator must not be activated

# Installation, Operation & Maintenance

**⚠ ATTENTION**

If lifting tackles (ropes or similar) are required for transport, these have to be attached in such a way that the actuator is not stressed and that neither the valve nor the gear are damaged.

Valves which are delivered without actuator or gear:  
The valve has to be transported carefully: the unsecured valve disc may open from closed position due to external effect.

## 5. Installation In The Pipeline

### 5.1 General Remarks

Instructions to install valves in a pipeline are similar to the instructions that apply as to connection of pipes and similar piping elements. The following instructions additionally apply to valves. For transport to the installation site, please also observe section 3.

**⚠ ATTENTION**

The sealing surfaces on bodies with flange ends of the FK-TriEX valve are designed in such a way that flange seals according to ANSI B16.21 are to be implemented.

Counter flanges must feature raised face, in accordance with ASME B16.5 and ASME B16.47 standard. Other raised face shapes are to be agreed on with the manufacturer.

To avoid any leakage on the flange connection:  
For a flange connection only suitable gaskets must be used.

**⚠ ATTENTION**

The actuator or gear is adjusted for the operating data stated in the order: The setting of the end stops "OPEN" and "CLOSED" must not be altered without the consent of the manufacturer.

If – in an exceptional case – a valve has to be mounted without actuator or gear, it has to be ensured that such a valve is not pressurized.

If an actuator or gear unit is retrofitted, torque, direction of rotation, operating angle and the setting of the end stops "OPEN" and "CLOSED" have to be agreed on with the manufacturer. The non-compliance of these instructions might involve danger to the user and cause damage to the pipe system.

**⚠ ATTENTION**

**Valves with electric actuator:**

It has to be made sure that the valve is shut off in "CLOSED" position by the signal of the torque switch. In "OPEN" position the valve has to be shut off with the signal of the limit switch. For further notes please refer to the manual for the electric actuator.

### 5.2 Working steps

Transport valve in the protective packaging to the installation site and unpack it only there.

Inspect valve, actuator and gear for damage in transport. Damaged valves or actuators must not be installed.

Make sure that only valves are installed the pressure class, connection type and connection dimensions of which meet the application requirements. See name plate on the valve.

The connection data for the actuator or gear has to correspond to the data of the control. See name plate on the actuator or gear.

The name plates or signs on the valve and actuator have still to be identifiable after commissioning.

**⚠ ATTENTION**

No valve must be operated the permissible pressure/temperature range (= "rating") of which is insufficient for the operating condition.

The non-compliance of this instruction involves a risk to life and limb and may cause damage to the pipe system.

## Installation, Operation & Maintenance

- At the beginning of the installation an operational check is to be carried out: the valve must close and open properly. Discernible malfunctions are absolutely to be redressed prior to commissioning. See also section 8 <Troubleshooting>. The position display on the actuator (if available) has to correspond to the position of the valve disc.
- Prior to installation the valve and the downstream pipeline have to be thoroughly cleaned of any contamination, especially of hard foreign substances.
- Crane® FK-TrieX full port Butterfly Valves can generally be installed irrespective of the flow direction. In order to benefit from the optimum function of the butterfly valve the following is recommended: Install the valve so that an arrow direction marked on the name plate with "PREFERRED" corresponds to the direction in which pressure is applied to a closed valve. This direction may well be opposite to the flow direction with opened butterfly valve!
- The preferred installation position is the one with horizontal valve shaft. If possible, a gear should not be mounted directly below the valve: stuffing box leakage could damage the gear.
- When inserting the valve (and the flange seals) in an already mounted pipeline the distance between the pipe ends has to be dimensioned in such a way that all connecting surfaces (and seals) remain undamaged. The gap, however, must not be larger than necessary so that no additional stress is generated in the pipeline during installation
- The counter flanges of the pipeline have to be flush, level and parallel.
- Flanged butterfly valves are to be centered on the counter flange during installation by means of the flange screws before the screws are tightened.

### ⚠ ATTENTION

**CRANE FK TrieX Butterfly Valves partly require screws of a varying length for the connection to the counter flanges.**

As usual the torque for tightening the flange screws has to be adapted to the strength of the screw materials used, the flange seal used and the operating conditions

### ⚠ ATTENTION

**FK-TrieX valves with actuator "safety position OPEN":  
For the installation in an existing pipeline the opened valve disc has to be closed with control medium and inserted into the line and screwed on in a completely closed state. Ensure for the duration of the DE installation process a supply with control medium is available with full control pressure for the closing of the butterfly valve.**

**If this is not possible, a part of the pipeline has to be removed so that the valve can be installed in opened position. The non-compliance of this instruction involves a major risk of injury.**

## Installation, Operation & Maintenance

- To the connection of the actuator to the control the manual of the actuator manufacturer applies.

At the end of the installation and operational check with the signals of the control is to be carried out: the valve has to close and open properly according to the control commands. Discernible malfunctions are absolutely to be redressed prior to commissioning. See also section 8, <Troubleshooting>.

**⚠ ATTENTION**

**Wrongly executed control commands could involve a risk to life and limbs and cause damage to the pipe system.**

### 6. Installation In The Pipeline

With the pressure test of valves the same instructions apply as to the pipeline. In addition, the following applies:

First thoroughly flush the newly installed line systems in order to flood out all foreign substances.

The testing pressure of an opened valve must not exceed the value of 1.5 x PS (at 20°C/ 68°F). The component with the lowest Pressure limits the maximum permissible testing pressure in the line section. (PS = maximum permissible operating pressure, see also name plate).

A closed valve must only be pressure-tested with 1.1 x PS. Valve needs to be pressure tested with flanges on both ends.

### 7. Normal operation and maintenance

**⚠ ATTENTION**

**In TA-Luft or FE applications the gland nuts must be tightened to the torques specified in 12.6 before 250 switching cycles.**

The valves are to be operated with the signals of the control. Valves which were delivered ex works with actuators or gears are exactly adjusted and must not be re-adjusted as long as the valve is in perfect working order.

For the actuation on the hand wheel of the actuator or gear (if available) normal manual forces are sufficient; the use of extensions to increase the actuation torque is not recommended.

Regular maintenance work on the valves is not required; however, when the line section is inspected no leakage must escape to the outside on any valve.

It is recommended to actuate those valves which remain always in one position once or twice a year!

**⚠ ATTENTION**

**A FK-TrieX valve is not self-locking: The actuator or gear must not be removed as long as the butterfly valve is pressurized**

**⚠ ATTENTION**

**A piston actuator is not self-locking: Piston actuators require a permanent supply with control pressure for all positions which are triggered under control pressure.**

## 8. Troubleshooting

Fault Type	Remedy	Note
Leakage on the flange connection or plug/ housing cover	<p>Retighten flange screws or plugs.</p> <p>If leakage cannot be redressed in this way: Repair required: replace seal: request spare part and necessary manual from Crane. Observe section 3.3, &lt;Particular dangers&gt;.</p>	
Leakage in the seat seal	<p>Check whether the valve is closed 100%. If this is the case: Check whether the valve is closed with full torque.</p> <p>If the valve, actuator or gear are o.k.: Open/ close valve repeatedly under pressure.</p> <p>If the valve is still leaking: Check whether leakage can be minimized by resetting the "CLOSED" stop in the actuator or gear (valve has to move further into the "CLOSED" position).</p> <p>If the valve is still leaking: Repair required: replace seat seal, request spare parts and necessary manual from Crane. Observe section 3.3, &lt;Particular dangers&gt;.</p>	
Leakage on the stuffing box	<p>Retighten gland nuts on the stuffing box gland alternately and in small steps of turn each clockwise.</p> <p>If leakage cannot be redressed in this way: Repair required: request spare parts and necessary manual from Crane 3.3, &lt;Particular dangers&gt;.</p> <p>If the nuts on the stuffing box gland have to be loosened or unscrewed (counter-clock- wise):</p> <p><b>Attention: In order to protect the operating personnel against any danger it has to be made sure that the line has been completely depressurised.</b></p>	<p>Note 1: If after the removal it is discovered that the body and/ or the inner parts are not sufficiently resistant to the medium, parts made of a suitable material are to be selected.</p>
Malfunction	<p>Check actuating unit and control commands. If actuator or gear are o.k.:</p> <p>Remove and inspect valve (in observance of the notes from section 3.3, &lt;Particular dangers&gt;).</p> <p>If the valve is damaged: Repair required: request spare parts and necessary manual from Crane.</p>	<p>Note 1: If after the removal it is discovered that the body and/ or the inner parts are not sufficiently resistant to the medium, parts made of a suitable material are to be selected.</p>
If an actuator with spring reset has to be removed	<p><b>Attention: Before the actuator is removed from the valve, depressure the pipeline and uncouple the actuator from the control pressure supply.</b></p>	

*In case of malfunctions on the actuator or gear see manual of the actuator or gear manufacturer.  
Spare parts are to be ordered with all specifications in the name plate. Only original parts must be installed.*

# Exploded View

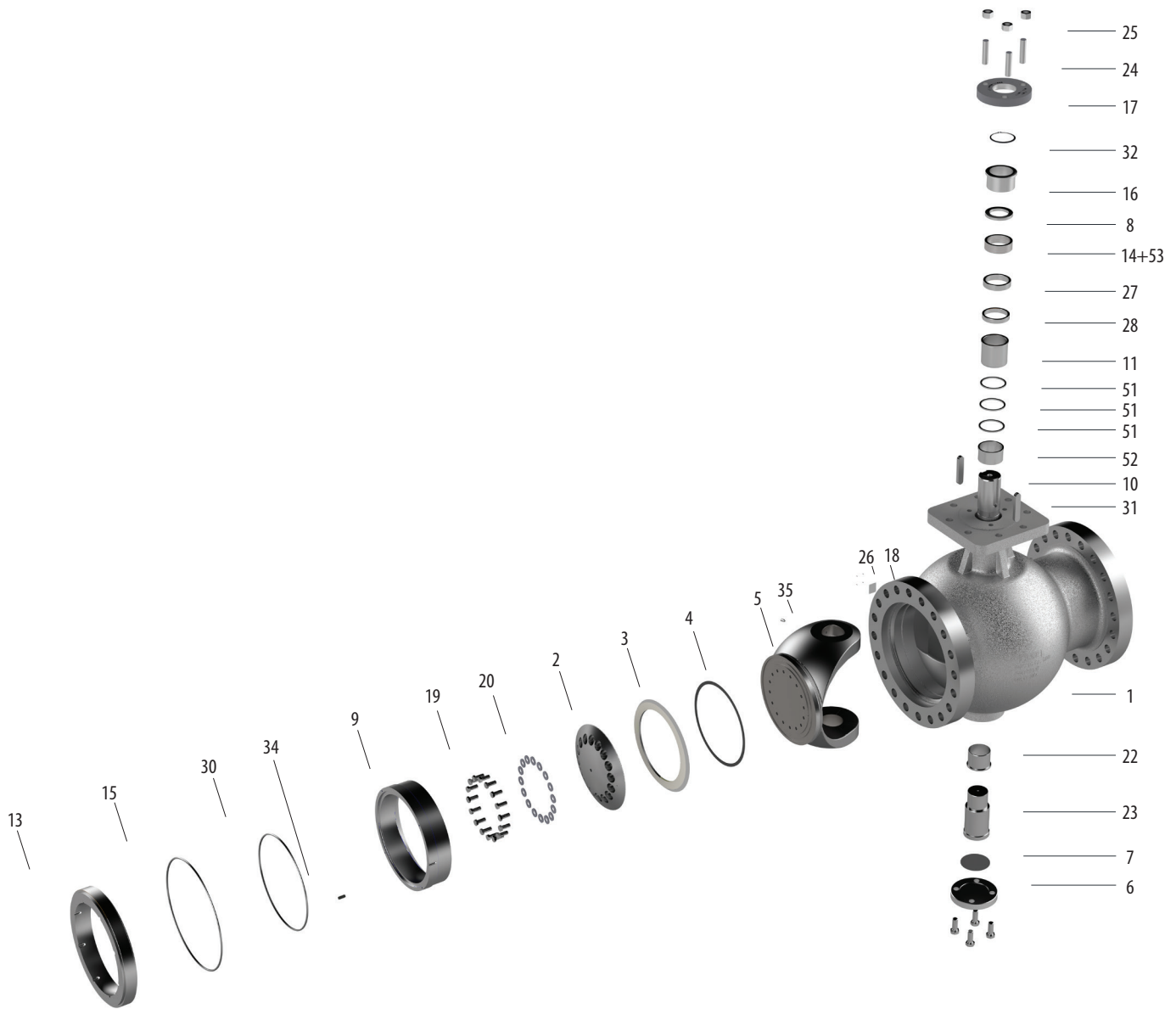



# Materials of Construction

Item	Description	Carbon Steel max. 700°F / 371°C*		Stainless Steel max. 700°F / 371°C*	
		ASTM	DIN	ASTM	DIN
1	Body	A216 Gr.WCB	1.0619	A351 Gr CF8M	1.4408
2	Seal Retainer Ring	A515 Gr.60	1.0425	A240 Gr.321	1.4541
3	Laminated seal	S31803/Graphite	1.4462/Graphite	S31803/Graphite	1.4462/Graphite
4	SPW gasket	1.4404/Graphite			
5	Disc	A216 Gr.WCB	1.0619	A351 Gr CF8M	1.4408
6	Cover	A516 Gr.60/A105	1.0425	A240 Gr.321	1.4541
7	Cover Gasket	1.4404 /Graphite			
8	Split Ring	A182 Gr. F51	1.4462	A182 Gr. F51	1.4462
9	Triex Ring	A105 / A216 Gr. WCB	1.0482 / 1.0619	A182-F316/ A351 Gr CF8M	1.4408
10	Shaft	A564 Gr. 630 (17-4 PH)	1.4542	A564 Gr. 630 (17-4 PH)	1.4542
11	Bearing	A582 Gr.303 coated	1.4305 coated	A582 Gr.303 coated	1.4305 coated
13	Insert	A105 / A216 Gr. WCB	1.0482 / 1.0619	A182-F316/ A351 Gr CF8M	1.4408
14	Packing	Graphite			
15	C-Seal	Inconel 718	Inconel 718	Inconel 718	Inconel 718
16	Gland	A582 Gr.303	1.4305	A582 Gr.303	1.4305
17	Gland Flange	A516 Gr.60	1.0425	A240 Gr.321	1.4541
18	Name Plate	A240 Gr.304	1.4301	A240 Gr.304	1.4301
19	Retainer Screw	A193 Gr.B8	A4-70	A193 Gr.B8	A4-70
20	Spring Washer	A4/ASTM 316			
21	Cover Screws	A193 Gr.B8	A4-70	A193 Gr.B8	A4-70
22	Disc bearing	A582 Gr. 303 coated	1.4305 coated	A582 Gr. 303 coated	1.4305 coated
23	Bottom shaft	A564 Gr. 630 (17-4 PH)	1.4542	A564 Gr. 630 (17-4 PH)	1.4542
24	Gland Stud	A193 Gr.B8	A4-70	A193 Gr.B8	A4-70
25	Gland Nut	A194 Gr.8	A4-70	A194 Gr.8	A4-70
26	Notched Nail	A29,Gr1012 Zinc plated	A4-70	A29,Gr1012 Zinc plated	A4-70
27	Upper Spacer	A582 Gr.304	1.4305	A582 Gr.304	1.4305
28	Lower Spacer	A582 Gr.304	1.4305	A582 Gr.304	1.4305
30	C-Seal	Inconel 718	Inconel 718	Inconel 718	Inconel 718
31	Drive key	A194 Gr.2	1.1191	A194 Gr.2	1.1191
32	Circlip	1.4310/1.4122/ ASTM 301			
34	Dowel Pin	SS316	1.4401	SS316	1.4401
35	Threaded Pin	A193 Gr.B8	A4-70	A193 Gr.B8	A4-70
51	Packing Ring	Graphite			
52	Pressure Tight Bush	A582 Gr.304	1.4305	A582 Gr.304	1.4305
53	Diffusion Barrier	Graphite			

\* consult factory for higher temperatures

# Dual Packing Design

Item	Description	Carbon Steel		Stainless Steel	
		ASTM	DIN	ASTM	DIN
13	Lantern ring	A582 Gr. 303	1.4305	A582 Gr. 303	1.4305
14	Packing	Graphite			
27	Spacer	A582 Gr. 303	1.4305	A582 Gr. 303	1.4305
30	Plug	A479 Gr. 316Ti	1.4571	A479 Gr. 316Ti	1.4571
33	Lantern ring	A582 Gr. 303	1.4305	A582 Gr.303	1.4305

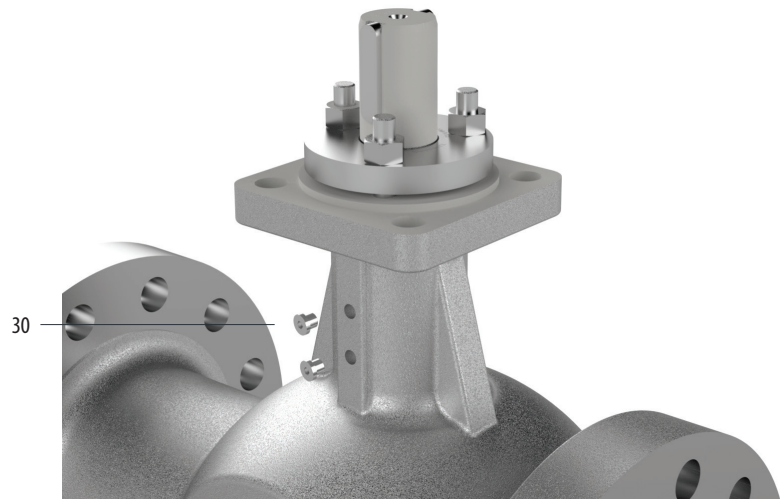
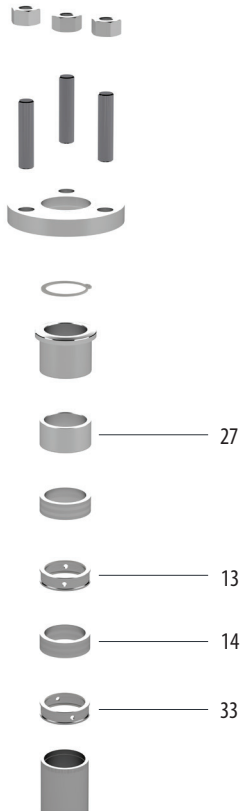

# Pressure Tight Bearing Design

Item	Description	Carbon Steel		Stainless Steel	
		ASTM	DIN	ASTM	DIN
28	Spacer	A582 Gr. 303 hardened	1.4305 hardened	A582 Gr. 303 hardened	1.4305 hardened
11	Bearing	A582 Gr. 303 coated	1.4305 coated	A582 Gr. 303 coated	1.4305 coated
51	Packing ring	Graphite			
52	PTB bush	A582 Gr. 303	1.4305	A582 Gr. 303	1.4305

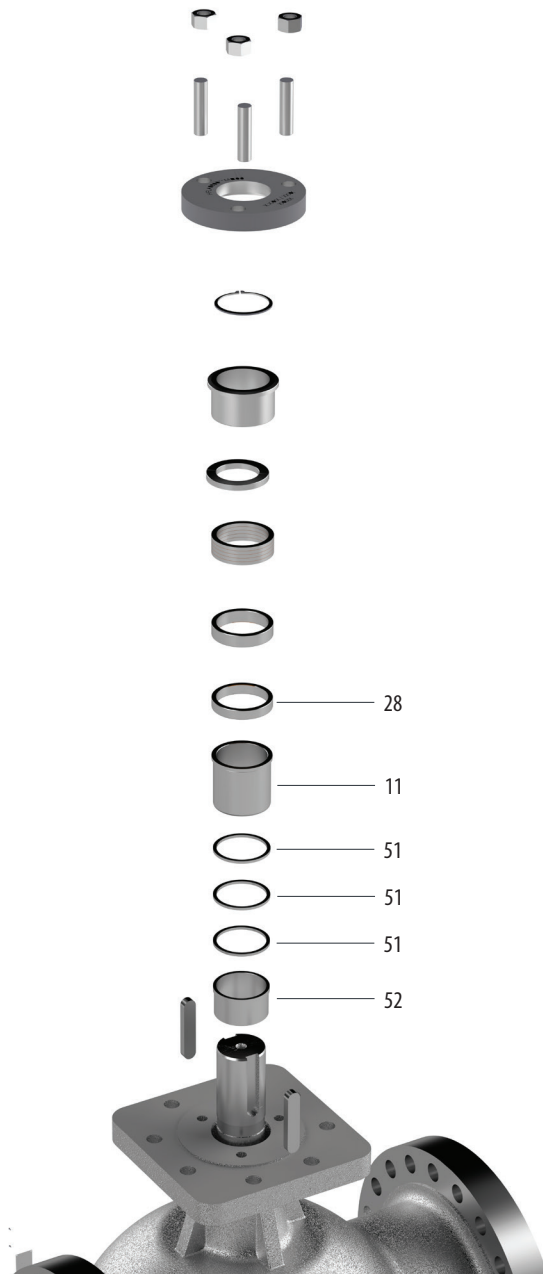

# Replacement of Spare Parts

## 9. Replacing FK-TrieX Lamina and Triex (Sealing kit)

The following table shows the content of the Lamina and triex .The items are shown in the exploded view.

Item	Description
3	Laminated seal
4	Seal gasket
15 & 30	C-seals

### 9.1 Disassembly

For the replacement of the recommended spare parts it is necessary to remove the valve from the pipe. The valve has to be turned into the closed position. It is recommended to replace the spare parts in a workshop.

**⚠ATTENTION**

**If lifting tools (for example ropes) are necessary to carry the valve to the workshop the actuator should be free from heavy load and the valve and actuator must not be damaged.**

**⚠ATTENTION**

**For shut-off flaps with single-acting drives, the drive must be in the safety position for reasons of safety in order to exclude accidental switching during installation. Danger to safety!**

1. Place the valve in a horizontal position with the retainer Screws (19) facing upwards.
2. Disassemble Threaded insert from body threads, Check movement : It shall be parallel to body flanges.

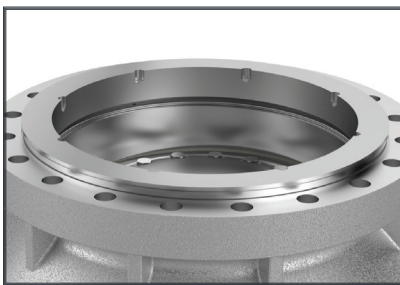

3. Remove both C-seals from body.

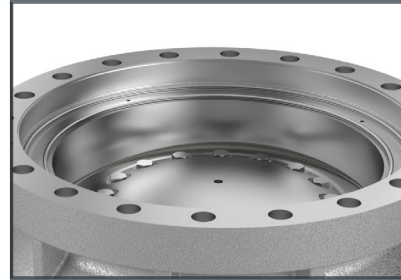

4. Remove Dowel pin from body and triex ring.

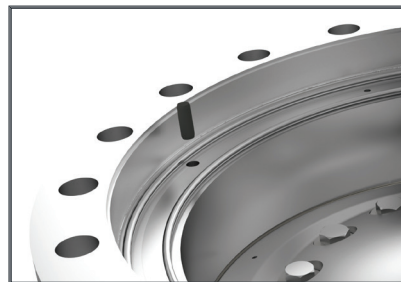

5. Remove TrieX ring from body

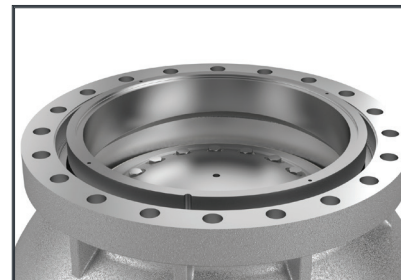

6. Loosen all retainer Screws (19) and remove all screws along with Spring washers (20).

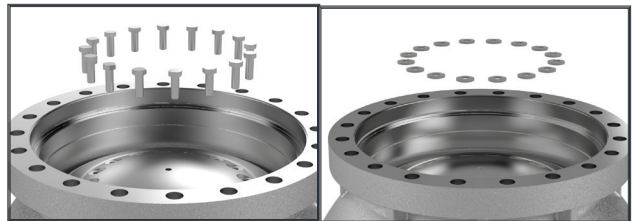

7. Remove Retainer ring (2) from disc (5)

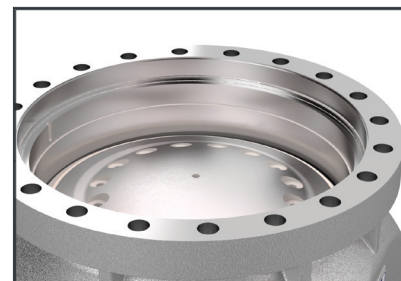

## Replacement of Spare Parts

8. Remove laminated seal (3)

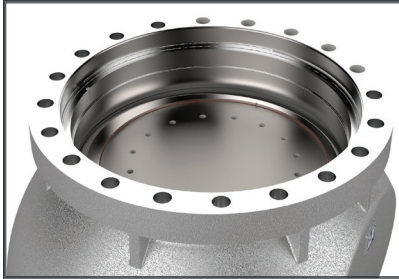

9. Remove seal gasket (4)

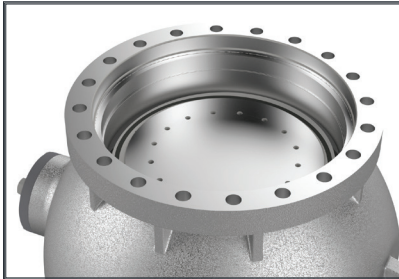

10. Clean the sealing surface on the disc carefully  
 11. Clean the seat surface on the Triex ring carefully. If necessary, polish the seat with abrasive paper 400 in circumferential direction

### ⚠ ATTENTION

**Check the seat surface for any damage or dent marks. Replace Triex ring, if dent marks above 1mm are found.**

### 9.2 Assembly of Lamina and Triex (Sealing kit)

Bring Disc (5) in close condition

1. Seal Gasket (4): Place and adjust the gasket with respect to locating groove of disc (5) to orient it properly
2. Laminate Seal (3) : Adjust the Laminate Seal (3) assembly according to locating holes on disc (5), with the larger side of the cone on to the seal gasket (4).
3. Retainer plate (2): Clean it, place it on Laminate Seal (3) by locating pin with Laminate Seal (3), gasket(4) and disc(5)
4. Retainer bolt with spring washer (19 &20): Use BOM and GA for quantity.
5. Apply grease on threaded surface of each bolt (19) and hand tight with retainer (2) and disc(5)

6. Triex Ring (9) : Insert triex ring (9) using dowel pin(34) location as reference in body(1) cavity
7. Dowel pin(34) : Adjust triex ring(9) w.r.t. dowel hole, put dowel pin (34) in hole to block the rotational movement of Triex ring
8. C-seal (15 & 30)- Clean C-sealing surface in body (1) and Triex ring (9), Apply graphite paste on C-seal(15&30), Place inner and outer C-seal / SPW gasket in groves
9. Threaded Insert (13): Assemble Threaded insert (13) in body (1) threads, Check movement. It shall be parallel to body(1) flanges
10. Use fixture and gear box arrangement to apply required torque on threaded insert(13).
11. Check the final position of threaded insert w.r.t. customer side flange
12. Slightly tighten the screws (19) manually, so that the Retainer ring (2) still remains movable; then remove the 2 pins.
13. To float in the lamella (3), the flap is firmly closed (e.g. with an installed manual gear). The Retainer ring (2) is clamped automatically in this process by ejecting the lamella seal (3).
14. Tighten all screws (19) crosswise with the torques per table in this document (Torque sheet Further Information)
15. Tighten gland nuts (25) if loosened during disassembly
16. Make a leakage test
17. Keep the valve closed for minimum. 24 hours
18. Retighten the retainer screws (19)

Additionally, 2 screws (19) are tightened with the torque according to table 12.4 and released again. After releasing the screws (19), align the clamping lid (2) and center it against the housing.

### ⚠ ATTENTION

**The screws of the seal retainer are to be retightened with a torque wrench prior to the installation of the butterfly valve into the pipeline (see also warning note on the seal retainer). The required torques are to be taken from the table on 12. Further Information or the detailed assembly and maintenance manual.**

# Replacement of Spare Parts

## 10. Maintenance on Body Gasket Kit (BGK)

The following table shows the content of the BGK and which options are included. The Item no 7 as shown in the exploded view.

Item	Description
7	Cover gasket

### 10.1 Disassembly

For the replacement of the recommended spare parts it is necessary to remove the valve from the pipe. The valve has to be turned into the closed position. It is recommended to replace the spare parts in a workshop.

**ATTENTION**

**If lifting tools (for example ropes) are necessary to carry the valve to the workshop the actuator should be free from heavy load and the valve and actuator must not be damaged.**

**ATTENTION**

**For shut-off flaps with single-acting drives, the drive must be in the safety position for reasons of safety in order to exclude accidental switching during installation. Danger to safety!**

1. Remove actuator or gear from valve taking care to remove drive key (31) from slot in stem.
2. Keep the valve in horizontal position with screws (19) on the top.
3. Remove Cover Bolts
4. Disassemble the cover
5. Safely remove body gasket

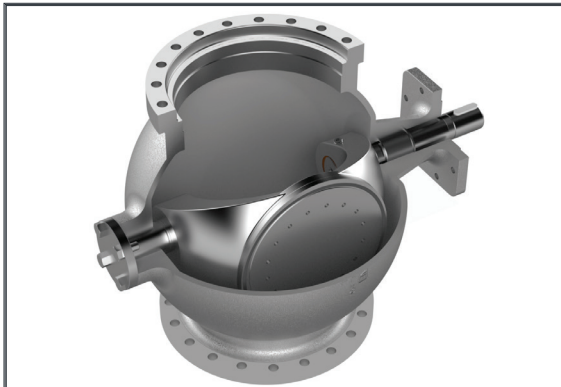

### 10.2 Inspection

Inspect the valve components for wear or damage. Be sure to carefully inspect cover (6) & Body (1) for nicks, cracks, breaks or other defects.

- Clean all areas thoroughly remove all signs of corrosion and media build-up. Recommended surfaces are
- sealing surfaces for cover gasket (7) at body (1) and cover (6)

### 10.3 Assembly

- Clean the body(1) and bottom shaft (23) resting face for cover (6) and Cover gasket (7).
- Install cover gasket (7) and cover (6) on body (1) and align the cover screws holes.
- Apply high temperature grease and tight the bolts (21) with the torque as per Torque table.

## Replacement of Spare Parts

### 11. Maintenance on Shaft Bearing & Packing

The following table shows the components and which options are included. The items are shown in the exploded view.

Item	Description
11	Bearing
12*	Bearing protector
14	Packing
51**	Packing ring

\*Standard bearing design only

\*\*Pressure tight bearing design only

#### 11.1 Disassembly

For the replacement of the recommended spare parts it is necessary to remove the valve from the pipe. The valve has to be turned into the closed position. It is recommended to replace the spare parts in a workshop.

#### ⚠ ATTENTION

**If lifting tools (for example ropes) are necessary to carry the valve to the workshop the actuator should be free from heavy load and the valve and actuator must not be damaged.**

#### ⚠ ATTENTION

**For shut-off flaps with single-acting drives, the drive must be in the safety position for reasons of safety in order to exclude accidental switching during installation. Danger to safety!**

1. Remove actuator or gear from valve taking care to remove drive key (31) from slot in stem
2. Keep the valve in horizontal position with screws (19) on the top.
3. Turn the disc (5) into lightly open position that the laminated seal has no more contact to the seat. Loose gland nuts (25) If necessary, open the disc carefully by using plastic hammer.
4. Turn valve 90° to a vertical position and open the disc (5) to a fully open position. A plastic hammer can be used to open the fitting by turning the disc with slight beat, and hold the disc by straps.
5. Remove the packing gland nuts (25), gland studs (24) and gland flange (17)
6. Remove Circlip (32)

7. Remove threaded pin (35) to lose shaft (10) from the disc (5)
8. Push shaft towards cover side until split ring (8) completely outside the disc. Use plastic hammer.
9. Remove split ring (8) from shaft.
10. Remove gland (16) and all other rings like spacers (27) (28) and spacers (27) (28) if available from shaft (10) together packing (14)
11. Remove the shaft (10) and upper bearing (11) by pulling them out of the body (1) through the top flange side
12. Remove PTB bush (52) and Packing ring (51) in case of Pressure tight design.

#### 11.2 Inspection

Inspect the valve components for wear or damage. Be sure to carefully inspect stem (10) for nicks, cracks, breaks or other defects.

Clean all areas thoroughly remove all signs of corrosion and media build-up. Recommended surfaces are

1. Sealing surface of packing (14) at body (1) and shaft (10)
2. Bearing surface at shaft (10)
3. Split ring groove in shaft (10)

## Replacement of Spare Parts

### 11.3 Assembly

1. Ensure Polygon clean surface. Upper bearing (11) are installed on the shaft (10). The bearings had to be greased on the inner diameter with a paste of molybdenum-sulfite-basis.
2. Install shaft (10) from top flange side into the body (1) through the disc (5) locate disc and shaft polygon.
3. Push shaft towards cover side and install split ring (8) into the shaft (5)
4. Pull back shaft up to the last position of split ring (8) into the disc (5)
5. Re-install both spacers (27 & 28)
6. Insert one JW seal + 1 diffusion Barrier, respectively
7. Grease the "gland tube" and the Gland and insert them onto the stem and push the stem seals deeper into the stem chamber.
8. Apply "Castrol Optimol paste TA" on the bolts and insert them into the top flange.
9. Insert the gland flange onto the stem
10. Grease the bolts and insert the nuts on it
11. Compress the packings to the assembly compression; Tighten the nuts incrementally to the torque specified on the compression table
12. Rotate the stem 5 times
13. Remove the gland flange, gland and the gland tube
14. Repeat this procedure for 5 times to install 5 packings
15. Reinstall gland (16)

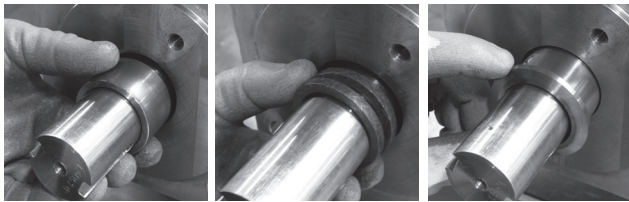

16. Reinstall shaft retainer ring (32)

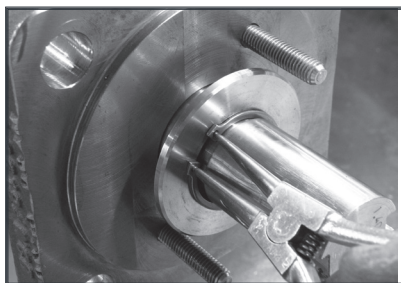

17. Reinstall gland studs (24), gland flange (17) and gland nuts (25). Lubricate the pin screws (24) and the support faces of the nuts (25) on the stuffing sleeve flange for tightening to the defined torque

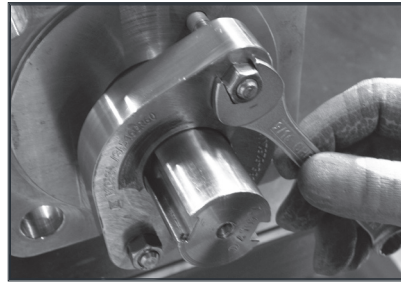

18. Reassemble drive keys (31) and actuator or gear



## Torques for Seal Retainer Screws

### Class 150

DN	NPS	Screw $\phi$	MA [Nm]
150	6"	M8	10
200	8"	M8	10
250	10"	M10	20
300	12"	M10	20
350	14"	M12	35
400	16"	M12	35
450	18"	M16	109
500	20"	M16	109
600	24"	M20	159

### Class 300

DN	NPS	Screw $\phi$	MA [Nm]
150	6"	M6	10
200	8"	M8	10
250	10"	M10	20
300	12"	M10	20
350	14"	M12	35
400	16"	M12	35
450	18"	M16	109
500	20"	M16	109
600	24"	M20	159

### Class 600

DN	NPS	Screw $\phi$	MA [Nm]
150	6"	M8	10
200	8"	M10	45
250	10"	M12	60
300	12"	M16	109
350	14"	M16	109
400	16"	M16	109
450	18"	M16	109
500	20"	M16	134
600	24"	M20	300

## Torques for Gland Flange

### Class 150

DN	NPS	Screw $\phi$	MA [Nm]
150	6"	5/8"-11 UNC	79
200	8"	5/8"-11 UNC	79
250	10"	5/8"-11 UNC	105
300	12"	3/4"- 10 UNC	147
350	14"	1"-8 UNC	349
400	16"	1"-8 UNC	371
450	18"	1"-8 UNC	560
500	20"	1"-8 UNC	560
600	24"	1 1/8"- 8 UN	821

### Class 300

DN	NPS	Screw $\phi$	MA [Nm]
150	6"	5/8"-11 UNC	79
200	8"	5/8"-11 UNC	79
250	10"	5/8"-11 UNC	105
300	12"	3/4"- 10 UNC	147
350	14"	1"-8 UNC	349
400	16"	1"-8 UNC	371
450	18"	1"-8 UNC	560
500	20"	1"-8 UNC	560
600	24"	1 1/8"- 8 UN	821

### Class 600

DN	NPS	Screw $\phi$	MA [Nm]
150	6"	9/16"-12 UNC	71
200	8"	5/8"-11 UNC	100
250	10"	3/4"- 10 UNC	175
300	12"	1"-8 UNC	349
350	14"	1"-8 UNC	371
400	16"	1"-8 UNC	410
450	18"	1-1/4"- 8 UN	682
500	20"	1-1/4"- 8 UN	738
600	24"	1 1/2"- 8 UN	1394

# Torque for Cover Screws

## Class 150

DN	NPS	Screw $\phi$	MA [Nm]
150	6"	1/2-13 UNC	65
200	8"	9/16-12 UNC	72
250	10"	5/8-11 UNC	126
300	12"	3/4-10 UNC	245
350	14"	3/4-10 UNC	245
400	16"	3/4-10 UNC	245
450	18"	1-8 UNC	343
500	20"	1-8 UNC	343
600	24"	1-8 UNC	421

## Class 300

DN	NPS	Screw $\phi$	MA [Nm]
150	6"	1/2-13 UNC	65
200	8"	9/16-12 UNC	72
250	10"	5/8-11 UNC	126
300	12"	3/4-10 UNC	245
350	14"	3/4-10 UNC	245
400	16"	3/4-10 UNC	245
450	18"	1-8 UNC	343
500	20"	1-8 UNC	343
600	24"	1-8 UNC	421

## Class 600

DN	NPS	Screw $\phi$	MA [Nm]
150	6"	5/8-11 UNC	126
200	8"	3/4-10 UNC	316
250	10"	3/4-10 UNC	316
300	12"	7/8-9 UNC	505
350	14"	7/8-9 UNC	505
400	16"	1-8 UNC	755
450	18"	1-8 UNC	755
500	20"	1-8 UNC	755
600	24"	1 1/4-8 UN	1491

**CRANE**<sup>®</sup>

**CRANE CHEMPHARMA & ENERGY**

Xomox International GmbH & Co. OHG  
Armaturenwerke  
Marburger Str. 364  
57223 Kreuztal, Germany  
Tel: +49 2732 520 00

Crane International Trading (Beijing) Co., Ltd.  
Room 1103, Capital Tower 11F  
6A Jianguomenwai Avenue Chaoyang District  
Beijing 100022, PR China  
Tel: +86 10 6563 9000

4526 Research Forest Drive,  
Suite 400  
The Woodlands  
Texas 77381, U.S.A.  
Tel: +1 936 271 6500

Xomox International GmbH & Co. OHG  
Von-Behring-Str. 15  
88131 Lindau, Germany  
Tel: +49 8382 702 0

ARMATURE d.o.o.  
Koroška cesta 55  
2366 Muta, Slovenia  
Tel: +386 2 877 05 00

Crane Ningjin Valve Co., Ltd.  
No. 496 Jing Long Street  
Ningjin County  
Hebei Province 055550, PR China  
Tel: +86 319 5808686

Crane Co., and its subsidiaries cannot accept responsibility for possible errors in catalogues, brochures, other printed materials, and website information. Crane Co. reserves the right to alter its products without notice, including products already on order provided that such alteration can be made without changes being necessary in specifications already agreed. All trademarks in this material are the property of the Crane Co. or its subsidiaries. The Crane and Crane brands logotype (CENTER LINE<sup>®</sup>, COMPAC-NOZ<sup>®</sup>, CRANE<sup>®</sup>, DEPA<sup>®</sup> & ELRO<sup>®</sup>, DOPAK<sup>®</sup>, DUO-CHEK<sup>®</sup>, FLOWSEAL<sup>®</sup>, GYROLOK<sup>®</sup>, GO REGULATOR<sup>®</sup>, HOKE<sup>®</sup>, JENKINS<sup>®</sup>, KROMBACH<sup>®</sup>, NOZ-CHEK<sup>®</sup>, PACIFIC VALVES<sup>®</sup>, RESISTOFLEX<sup>®</sup>, REVO<sup>®</sup>, SAUNDERS<sup>®</sup>, STOCKHAM<sup>®</sup>, TEXAS SAMPLING<sup>®</sup>, TRIANGLE<sup>®</sup>, UNI-CHEK<sup>®</sup>, VALVES<sup>®</sup>, WESTLOCK CONTROLS<sup>®</sup>, WTA<sup>®</sup>, and XOMOX<sup>®</sup>) are registered trademarks of Crane Co. All rights reserved.